

March 2024

Roadway Traffic Control and Communications Manual

ILLINOIS STATE TOLL HIGHWAY AUTHORITY

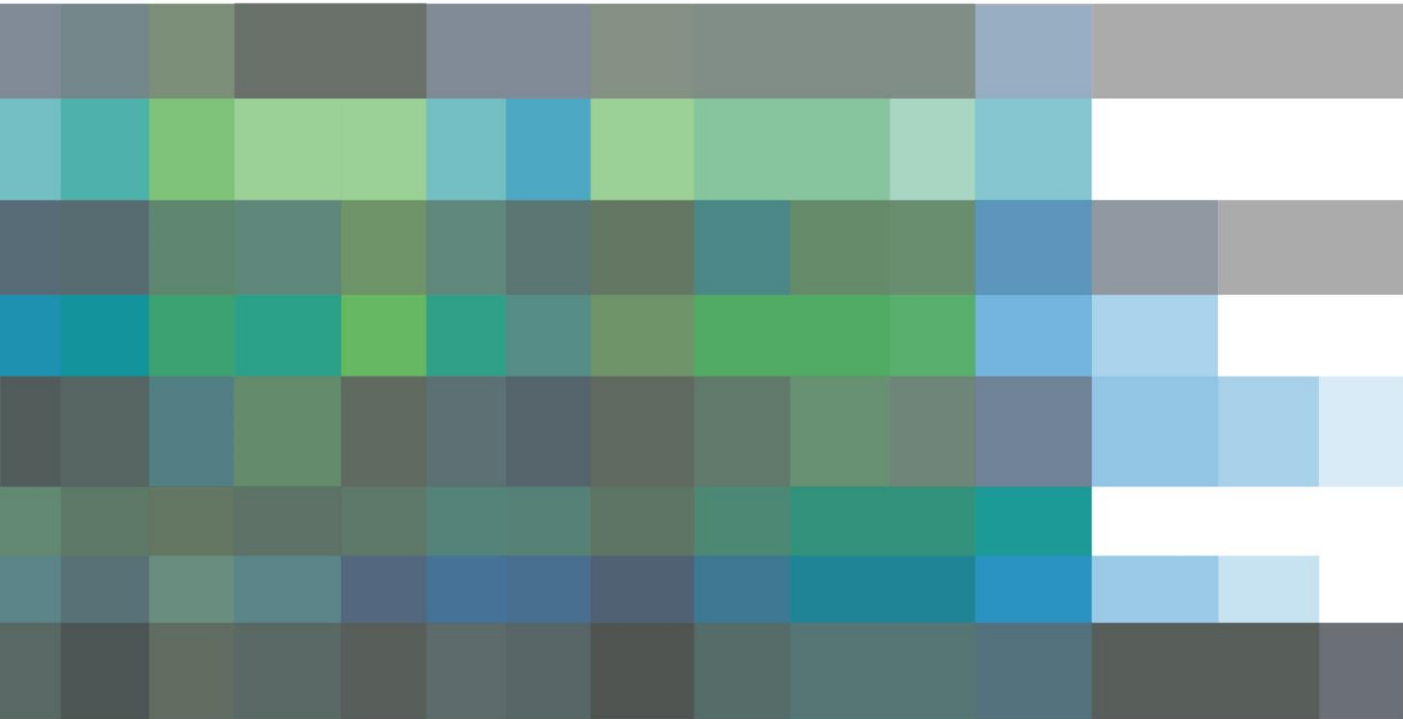



INTRODUCTION

Roadway Traffic Control and Communications Manual

The Roadway Traffic Control and Communications Manual provides guidance on the Illinois Tollway standards for managing the control of traffic on the system. The manual's content provides a detailed listing of criteria, guidelines, policies and procedures to be followed while identifying work zone issues, along with developing comprehensive work zone strategies and plans for the establishment of work zone traffic control. This content is intended to address the overall safety, mobility and constructability of Illinois Tollway projects.

The Roadway Traffic Control and Communications Manual dated March 2024 replaces the previous version dated March 2023.

Major Revision Highlights:

Section 1.0: Introduction	
Article 1.2	Updated reference to MASH.
	Added lower case acronym for miles per hour.
	Revised acronym for Proprietary Temporary Traffic Barrier
Article 1.3	Revised definition of Barrier Clearance Distance
	Revised should to shall in the definition of Buffer Space
	Added Design-Builder team to definition of Designer and included Design-Builder in the definition of Stage and Stakeholder.
Section 3.0 Project Communications	
Article 3.3.2	Added Design-Builder to list of attendees
Article 3.4.2	Revised times lane closure request are due to the Engineer
Section 5.0: Principles of Traffic Control	
Article 5.3.2.3.14	Revised name of Appendix and added Design-Builder.
Article 5.3.5	Added Design-Builder
Article 5.3.7	Added criteria for when Emergency Pullouts are to be provided.
Article 5.3.8	Deleted “no positive protection is provided and”.
Article 5.3.13	Revised criteria to include when Case II Condition C may be used.
Section 6.0: Device Requirements	
Article 6.1	Revised references from MASH-16 to MASH.
Article 6.3	Revised Toll Plaza to tolling.
Article 6.4.1.2	Clarified function of barrier-type channelizing devices
Article 6.4.4.4	Remove size of indicator arrow.
Article 6.4.7.2	Revised chain to stiffened barrier line.
Article 6.4.7.5	Removed reference to NCHRP 350
Article 6.4.7.7	Added PTTB shall not be anchored to new bridge decks and approach slabs.
Article 6.4.7.9	Added extended.
Article 6.4.7.10	Clarified timeframe for the reinstallation of guardrail.
Article 6.6.3.1.2	Clarified position of flood, spot or stadium luminaires
Article 6.6.5.1	Revised day time use to short-term stationary and night time use to intermediate-term stationary and long-term stationary
Article 6.6.5.3	Deleted positioning arrow boards in the center of the closed lane.
Article 6.7.6	Revised name of Article and specified radar speed display units shall be provided per Standard Drawing.
Article 6.7.7	Deleted MASH TL-2.
Section 7.0 Use of Positive Protection	
Article 7.0	Delete MASH.
Section 8.0 Longitudinal Drop-Off Policy	
Article 8.0	Added sign spacing requirements for Condition 1 and Condition 2.

Article 8.0	Revised minimum distance between edge of traveled way to edge of drop off from 3'-6" to 3'-10" for Condition 6.
Section 11.0 Installation and Operation of Work Zones	
Article 11.4.1	Added requirements for storage areas behind free-standing and anchored temporary concrete barrier.

TABLE OF CONTENTS

SECTION 1.0	INTRODUCTION	1
1.1	Purpose and Use	1
1.2	Abbreviations and Acronyms	2
1.3	Definitions	3
SECTION 2.0	PROJECT CONSIDERATIONS	8
2.1	Relationship to other Manuals/Guidelines	8
2.2	Concepts	8
2.3	Application	9
2.4	Illinois Tollway Traffic Operations and Safety Committee	9
SECTION 3.0	PROJECT COMMUNICATIONS	11
3.1	Information to Report	11
3.2	Emergency Communication Plan	11
3.3	Maintenance of Traffic Advance Coordination Meeting (Mandatory)	11
3.3.1	Responsibility and Authority	11
3.3.2	21 Day Advance Coordination Meeting	11
3.3.3	2 Day Advance Coordination Meeting	12
3.4	Closure Requests	13
3.4.1	10 Day Advance Lane/Shoulder Closure Request	14
3.4.2	Daily Lane Closure Requests & Revisions	14
3.4.3	Emergency Closure/Holiday	14
3.5	Cancellations and Changes	14
3.5.1	Cancellation of Lane Closure Request	14
3.5.2	Lane Closure Change Procedures	14
3.6	Reporting Lane Closure Status Procedure	14
3.7	Minimizing Traffic Impacts-Avoiding Conflicts	15
SECTION 4.0	PROJECT INFORMATIONAL SIGNING	17
4.1	Objectives	17
4.2	Sign Content	17
4.3	Number (in Each Direction) and Type of Signs	18
4.3.1	Major/Long-term Project	18
4.3.2	Minor/Medium-term Project	18
4.3.3	Short-term Project	18
4.3.4	Daily Construction or Lane Closures	19
4.3.5	Project Informational Signs	19

4.4	Timing of Sign (or Series of Signs) Installations _____	19
4.5	Responsibilities _____	19
SECTION 5.0 PRINCIPLES OF TRAFFIC CONTROL _____		21
5.1	Objectives _____	21
5.2	Definition of Terms _____	21
5.2.1	Elements of a Work Zone _____	21
5.3	Considerations _____	23
5.3.1	Work Zone Safety and Mobility _____	23
5.3.2	Work Zone Speed Limit _____	24
5.3.3	Work Zone Trooper Assistance _____	32
5.3.4	Work Zone Clear Zone _____	32
5.3.5	Contractor Access to Work Area _____	33
5.3.6	Stabilized Construction Entrance _____	34
5.3.7	Pull Out Areas _____	34
5.3.8	Lane Closure _____	35
5.3.9	Interior Lane Closure _____	35
5.3.10	Tapers _____	35
5.3.11	Counter-Flow Lane _____	36
5.3.12	Use of Shoulder _____	37
5.3.13	Reduced Lane Width _____	38
5.3.14	MOT Modifications _____	38
5.3.15	Temporary Stoppage of Traffic _____	38
5.3.16	Night Work _____	38
5.3.17	Mainline Open Road Tolling Work _____	39
5.3.18	Mainline Plaza Work (Non-Open Road Tolling) _____	39
5.3.19	Ramp Plaza Work _____	40
5.3.20	Interchange Ramp Work _____	40
5.3.21	Use of Positive Protection Devices _____	41
5.3.22	Longitudinal Drop-Off Policy _____	41
5.3.23	Detour Routes _____	41
5.3.24	Rollover and Lane Straddling _____	41
5.3.25	Use of Road Steel Plates _____	41
5.3.26	MOT During Winter Season _____	41
5.4	Application of Principles _____	42
5.4.1	Uniformity _____	42
5.4.2	Adaptation _____	42
5.4.3	Compensation _____	42
5.4.4	Redundancy _____	42
5.5	Duration _____	43
5.5.1	Short Duration _____	43

5.5.2	Short Term Stationary	43
5.5.3	Intermediate Term Stationary	43
5.5.4	Long Term Stationary	44
5.5.5	Mobile Operations	44
SECTION 6.0 DEVICE REQUIREMENTS		46
6.1	Safety Hardware Testing	46
6.2	General Requirements	47
6.3	Signs	48
6.3.1	Sign Usage	48
6.3.2	Sign Design	48
6.3.3	Sign Sizes	48
6.3.4	Sign Placement	49
6.3.5	Sign Mountings	50
6.3.6	Special Signs	50
6.4	Channelizing Devices	50
6.4.1	General Characteristics	50
6.4.2	Cones	52
6.4.3	Drums	52
6.4.4	Barricades	52
6.4.5	Vertical Panels	54
6.4.6	Tubular Markers	54
6.4.7	Barriers	55
6.5	Pavement Markings	61
6.5.1	Background	61
6.5.2	Requirements	61
6.5.3	Materials	61
6.5.4	Pavement Markings Removal	62
6.6	Lighting Devices	62
6.6.1	General Applications	62
6.6.2	Warning Lights	62
6.6.3	Nighttime Lighting	63
6.6.4	Beacons	64
6.6.5	Arrow Boards	65
6.6.6	Portable Changeable Message Signs	66
6.7	Other Devices	67
6.7.1	Attenuators	67
6.7.2	Lane Channelizers	68
6.7.3	Flexible Delineator Posts	68
6.7.4	Glare Screens	68
6.7.5	Barrier Reflectors	69

6.7.6	Trailer Mounted Radar Speed Display Units _____	69
6.7.7	Truck Mounted Attenuators _____	69
SECTION 7.0	USE OF POSITIVE PROTECTION DEVICES _____	70
7.1	Typical Positive Protection Devices _____	70
7.2	Measures and Strategies _____	72
7.3	Use of Positive Protection Devices _____	72
7.3.1	Condition I: Use by Engineering Judgment _____	72
7.3.2	Condition II: Mandatory Use in Work Zones _____	73
SECTION 8.0	LONGITUDINAL DROP-OFF POLICY _____	75
SECTION 9.0	INTELLIGENT TRANSPORTATION SYSTEMS & TECHNOLOGY _____	81
9.1	Removal, Relocation, Calibration, or Storage Procedures _____	81
SECTION 10.0	SMART WORK ZONE _____	83
SECTION 11.0	INSTALLATION AND OPERATION OF WORK ZONES _____	84
11.1	Installation, Modification and Removal _____	84
11.1.1	Need for Expediency _____	84
11.1.2	Types of Closures _____	84
11.1.3	Preparation _____	84
11.1.4	Notification _____	85
11.1.5	Sequence _____	87
11.1.6	Allowable Lane Closure Schedule _____	89
11.1.7	Special Techniques _____	89
11.1.8	Ballasting Devices _____	89
11.2	Work Zone Evaluation _____	90
11.2.1	Evaluation Following Installation _____	90
11.2.2	Work Zone Performance _____	90
11.3	Maintenance of Traffic Control Devices _____	90
11.3.1	Inspection of Work Zones _____	90
11.3.2	Maintenance _____	91
11.4	Work Operations _____	91
11.4.1	Work and Storage Locations _____	91
11.4.2	Traffic Control during Non-work Periods _____	92
SECTION 12.0	WORKER PROCEDURES _____	93
12.1	General _____	93
12.1.1	Recognition of Hazards _____	93
12.1.2	Work Zone Practices _____	93
12.1.3	Obeying Rules and Regulations _____	94
12.1.4	Worker Attire _____	94

12.2	Flagging and Spotting _____	94
12.2.1	Flagging and Spotting Functions _____	94
12.2.2	Flagging and Spotting Devices _____	94
12.2.3	Flagging & Spotting Procedures _____	95
12.2.4	Flagger & Spotter Training _____	95
SECTION 13.0 MAINTENANCE OF TRAFFIC PROCEDURES _____		96
13.1	Use of Plates _____	96
13.2	Description of Plates _____	96
13.2.1	Off Road Activities _____	96
13.2.2	Shoulder Closure _____	96
13.2.3	Mainline Lane Closures _____	96
13.2.4	Ramps _____	96
13.2.5	Toll Plazas _____	97
13.2.6	Moving Operations _____	97
13.2.7	Emergency Situations _____	97
13.2.8	Mainline ORT Maintenance _____	97
SECTION 14.0 QUALITY STANDARDS – TRAFFIC CONTROL DEVICES _____		99
SECTION 15.0 MAINTENANCE OF TRAFFIC PLATES AND NOTES _____		100
15.1	General Notes for the MOT Plates _____	100
15.2	Plates 1 Through 15 _____	101
15.2.1	Plate 1 - No Closure Required _____	102
15.2.2	Plate 2 - Typical Temporary Shoulder Closure _____	103
15.2.3	Plate 3r - Typical Temporary Right Lane Closure _____	104
15.2.4	Plate 3l - Typical Temporary Left Lane Closure _____	105
15.2.5	Plate 4r - Typical Temporary Two Right Lanes Closure _____	106
15.2.6	Plate 4l - Typical Temporary Two Left Lanes Closure _____	107
15.2.7	Plate 5 - Typical Temporary Work On Acceleration Lane _____	108
15.2.8	Plate 6 - Typical Deceleration Lane And/Or Ramp Lane Closure _____	109
15.2.9	Plate 6a - Typical Deceleration Lane Closure _____	110
15.2.10	Plate 7 - Typical Work In Toll Plaza _____	111
15.2.11	Plate 8 - Typical Mobile Operation On Shoulder _____	112
15.2.12	Plate 9r - Typical Mobile Operation-Single Right Lane Closure _____	113
15.2.13	Plate 9l - Typical Mobile Operation-Single Left Lane Closure _____	114
15.2.14	Plate 10r - Typical Mobile Operation-Two Right Lanes Closure _____	115
15.2.15	Plate 10l - Typical Mobile Operation-Two Left Lanes Closure _____	116
15.2.16	Plate 11r - Typical Right Lane Closure-Emergency Situation _____	117
15.2.17	Plate 11l - Typical Left Lane Closure-Emergency Situation _____	118
15.2.18	Plate 12r - Typical Two Right Lanes Closure-Emergency Situation _____	119
15.2.19	Plate 12l - Typical Two Left Lanes Closure-Emergency Situation _____	120

15.2.20	Plate 13 - Plaza Maintenance Full Ort Closure-Two Lanes _____	121
15.2.21	Plate 14 - Plaza Maintenance Full Ort Closure-Three Lanes _____	122
15.2.22	Plate 15 - Plaza Maintenance Full Ort Closure-Four Lanes _____	123

TABLES

TABLE 1	Suggested Flate Rates for TCB _____	57
---------	-------------------------------------	----

FIGURES

FIGURE 1	Emergency Lane Closure Request/or After Hour Lane Closure Changes _____	16
FIGURE 2	Elements of a Work Zone _____	22
FIGURE 3	Temporary Concrete Barrier Layouts _____	59
FIGURE 4	General Process for Lane Closure Notification _____	86
FIGURE 5	Interior Closure Installation Procedure _____	88

APPENDICES

APPENDIX A	Construction Communication Roles and Responsibilities
APPENDIX B	Traffic Forms
APPENDIX C	Procedures for Placing Traffic Control Signage
APPENDIX D	Work Zone Safety Inspection Checklist
APPENDIX E	Illinois Department of Transportation Standards
APPENDIX F	Flow Charts for Consideration of Work Zone Speed Limits
APPENDIX G	Work Zone Speed Limit Form

SECTION 1.0 INTRODUCTION

1.1 Purpose and Use

The ROADWAY TRAFFIC CONTROL AND COMMUNICATIONS MANUAL for the ILLINOIS TOLLWAY (hereinafter referred to as 'MOT MANUAL') is designed to provide policies, procedures, and guidelines to be used in identifying work zone issues, along with developing comprehensive work zone strategies and plans for the establishment of work zone traffic control on the Illinois Tollway which address the project's overall safety, mobility and constructability issues.

This MOT MANUAL provides a written account of how certain activities are to be performed and is designed to guide and assist various personnel in performing their functions. When appropriate, there may be deviations from these written procedures due to specific project conditions.

This manual is to be followed by the Designer, Construction Manager (CM), Illinois Tollway personnel, and contract forces for all construction, maintenance, and utility operations performed on the Illinois Tollway system. Everyone involved in a project's development and delivery including field operations must be committed to providing safety and mobility for all activities. Addressing these safety and mobility issues requires considerations that start early in project development and continue through project completion.

Illinois Tollway projects are planned, designed, and constructed through a phased project management process as described in Section 4 of the Illinois Tollway's Design Section Engineer's Manual. All work zones, individual work areas and operational requirements for construction need to be identified and addressed during the project's development, design phases and environmental review. Work zone activities, along with their impacts, mitigation, and costs should be evaluated at the same time as, and in conjunction with, other design factors. A systematic approach in evaluation of work zone issues is essential in the ability to identify and address the potential resultant work zone consequences.

The Maintenance of Traffic (MOT) plan must consider existing, temporary and proposed elements that are typically within the roadside, project costs, productivity, along with promoting motorist and worker safety. Elements within or in close proximity to the work area clear zone should be further evaluated utilizing the procedures and principals outlined in the Illinois Tollway Traffic Barrier Guidelines (TBG).

This manual contains measures of Federal Highway Administration (FHWA) Subpart K to 23 Code of Federal Regulations (CFR), Part 630, to decrease the likelihood of highway work zone fatalities and injuries to workers and road users. These measures establish requirements and provide guidance for the use of positive protection devices between the work area and motorized traffic, installation and maintenance of temporary traffic control devices, and use of uniformed law enforcement officers during construction, utility, and maintenance operations.

The fundamental purpose of assessing and managing the work zone impacts of road construction, utility and maintenance projects lies in:

- Safety – Maximizing the safety of road users and highway workers.
- Mobility – Maximizing mobility and accessibility on roadways.

- Constructability – Planning, designing, and building projects as effectively and efficiently as possible. Constructability is the ease with which a design can be implemented on the construction site. Constructability reviews are to be performed as described in Section 7, Quality Assurance of the Illinois Tollway’s Design Section Engineer’s Manual.

The traffic control procedures defined in the MOT Plates contained in this MOT MANUAL as well as the Illinois Tollway Standards were developed to meet the dual objectives of providing a high level of safety for Illinois Tollway users and protection of workers.

1.2 Abbreviations and Acronyms

AASHTO	American Association of State Highway and Transportation Officials
AASHTO RDG	AASHTO Roadside Design Guide
ANSI	American National Standards Institute
CCCCFR	Construction Communications Coordinator
CCM	Corridor Construction Manager
CCTV	Closed Circuit Television
CM	Construction Manager
DCM	Design Corridor Manager
DMS	Dynamic Message Sign
DSE	Design Section Engineer
EOP	Edge of Pavement
EOS	Edge of Paved Shoulder
EOTW	Edge of Traveled Way
FHWA	Federal Highway Administration
FMPCMS	Full Matrix Portable Changeable Message Sign
GEC	General Engineering Consultant
GPS	Global Positioning System
HMA	Hot-Mix Asphalt
IDOT	Illinois Department of Transportation
IPO	I-PASS Only
ISP	Illinois State Police
IT	Information Technology
ITS	Intelligent Transportation System
MASH	Manual for Assessing Safety Hardware, 2016 Edition
MOT	Maintenance of Traffic
MOT MANUAL	Roadway Traffic Control and Communications Manual for the Illinois Tollway
MPH (mph)	Miles per Hour
MUTCD	Manual on Uniform Traffic Control Devices for Streets and Highways
MVDS	Microwave Vehicle Detection System
NCHRP	National Cooperative Highway Research Program
NPDES	National Pollutant Discharge Elimination System
ORT	Open Road Tolling
PCL	Project Communication Liaison
PCMS	Portable Changeable Message Sign
PM	Project Manager

PTTB	Proprietary Temporary Traffic Barrier
RQDS	Ramp Queue Detection System
RWIS	Roadway Weather Information System
SWZ	Smart Work Zone
TBG	Traffic Barrier Guidelines
TIMS	Traffic Information Management System, also TOC
TMA	Truck/Trailer Mounted Attenuator
TOC	Traffic Operations Center, also TIMS
VWIM	Virtual Weigh in Motion
WBPM	Web-Based Project Management system
WZSL	Work Zone Speed Limit

1.3 Definitions

Activity Area: The Activity Area is that portion of the roadway which contains the Buffer Space and Work Area from which traffic is excluded and the portion of the roadway used to carry traffic adjacent to the Work Area. It is located downstream from the Advance Warning Area and the Transition Area (if one exists). The typical devices located in this area are channelizing devices and appropriate signage.

Advanced Warning Area: The Advanced Warning Area of a Work Zone is the area located upstream of the Transition Area in the direction of traffic within which signs informing drivers of what to expect are placed. It starts at the beginning of the Work Zone and extends to the point where the first channelizing device is placed. Typically, the only traffic control devices located in this area are signs, Portable Changeable Message Signs (PCMS), Arrow Boards, and their associated barricades.

Barrier Clearance Distance: The Barrier Clearance Distance is the area behind the barrier, equal to the Lateral Deflection that shall be kept clear of material, equipment, and workers.

Barrier Warrant: A Barrier Warrant consists of criterion that identifies an area of concern which should be shielded by a traffic barrier, if judged to be practical. The warrant shall be based on Illinois Tollway Traffic Barrier Guidelines and American Association of State Highway and Transportation Officials Roadside Design Guide (AASHTO RDG).

Buffer Space: The Buffer Space is a space within the Activity Area with a minimum length of 200 feet for shoulders and 650 feet for mainline pavement which is located immediately in advance of the Work Area. It shall be kept clear of workers and materials in order to provide additional recovery space for an errant vehicle that may penetrate the taper in the Transition Area.

Chief Engineering Officer: The individual responsible for the Engineering Division of the Illinois Tollway.

Clear Zone: The clear zone is defined by the American Association of State Highway and Transportation Officials Roadside Design Guide (AASHTO RDG) as “The unobstructed, traversable area provided beyond the edge of the through traveled way for the recovery of errant vehicles.” See the Illinois Tollway Traffic Barrier Guidelines (TBG) Article 5.3 for detailed definition and application of clear zones by the Illinois Tollway.

Closure: A Closure involves the taking of some portion of the roadway (including lanes and/or improved shoulders) for the exclusive use of workers, equipment operations or material storage during a work operation. At a crash scene, a Closure may be created for the storage of disabled vehicles, emergency responders, or police vehicles.

Construction Manager (CM): The Engineer or firm of engineers and their duly authorized employees, agents and representatives retained by the Illinois Tollway to observe the Work to determine whether or not it is being performed and constructed in compliance with the Contract.

Counter-Flow Lane: A Counter-Flow Lane is a lane operating in a direction opposite to the normal flow of traffic. Counter-Flow Lanes are separated from the opposite direction lanes by temporary concrete barrier (TCB) or permanent barrier wall.

Daily: Daily is typically the range of time to perform work during the day or night; lasting less than 24 hours.

Designer: The person (or consultant team) responsible for performing a design task for an Illinois Tollway project. Although this is typically the Design Section Engineer (DSE), it can also include a person (or consultant team) hired by a Contractor to perform design as part of a Value Engineering Proposal, a Design-Build team or part of a Performance Based Design. This document will use the term “Designer” which covers anyone performing design and will only use the term “DSE” when discussing tasks specific to the DSE.

Drop-off: A drop-off is defined as an elevation difference between adjacent traveled lanes, between a traveled lane and an adjacent shoulder, between a lane or shoulder and other lower surface (such as an excavation), or between the surface of a bridge deck and an exposed grid of reinforcement bar supported along its perimeter by structural concrete. Pavement patching is not considered a drop-off condition, except when individual patching holes are left open in excess of 24 hours.

Fast Moving Mobile Operations: Fast Moving Mobile Operations are those that move at speeds between five and thirty miles per hour (MPH).

Guideline: A Guideline is an official recommendation indicating how something should be done or what sort of action should be taken in a particular circumstance.

Impact Attenuator: Also called “Energy Attenuator”. An energy absorbing device used to shield a rigid fixed object, such as a concrete barrier, a median barrier, or a bridge pier, by gradually decelerating the vehicle to a safe stop or by redirecting the vehicle away from the fixed object.

Intelligent Transportation System (ITS): The application of advanced electronic technologies and communications infrastructure in transportation to improve traveler information, increase motorist safety, speed incident response, enhance productivity, and reduce congestion; ITS must be explicitly integrated with operations to be effective.

Intermediate Term Stationary Work: Intermediate-Term Stationary Work is work that occupies a location for more than 1 daylight period up to 3 days, or nighttime work lasting more than 1 hour.

Intermittent Stop Mobile Operations: Intermittent Stop Mobile Operations are those which are constantly being relocated along the highway.

Lateral Deflection: Lateral Deflection is the distance that the barrier travels laterally based on either National Cooperative Highway Research Program (NCHRP) 350-Test Level 3 or Manual for Assessing Safety Hardware (MASH) Test Level 3 crash test.

Long-Term Stationary Work: Long-Term Stationary Work is work that occupies a location for more than 3 days.

Maintenance of Traffic (MOT): MOT is a plan developed to provide for safe and efficient motorists travel during staged construction.

Major/Long-Term Project: A Major/Long-Term Project is a project which has a duration greater than 1 month and length greater than 5 miles.

Minor/Medium-Term Project: A Minor/Medium Project is a project which has a duration greater than 1 month and length less than 5 miles.

Managed Work Area: A process to systematically assess the work zone impacts of projects, implementing strategies related to establishing the safest and most efficient speed limit for work zone based on roadway conditions.

Manual on Uniform Traffic Control Devices (MUTCD): The Federal Highway Administration (FHWA) National Manual on Uniform Traffic Control Devices for Streets and Highways and as amended by the State of Illinois Department of Transportation (IDOT) supplement to the MUTCD. Publication which defines the standards used by road managers nationwide to install and maintain traffic control devices on all public streets, highways, bikeways, and private roads open to public traffic. The MUTCD is published by the FHWA under 23 Code of Federal Regulations (CFR), Part 655, Subpart F.

Policy: A Policy is a defined course of action established by a set of principles which shall be followed.

Roadway: A Roadway consists of all through lanes, auxiliary lanes and shoulders in one direction of travel.

Short Duration: Short Duration is typically the range of time required to perform short-duration work which is less than one hour.

Short-Term Project: Short-Term Project is a project which has a duration less than 1 month.

Short-Term Stationary Work: Short-Term Stationary Work is daytime work that occupies a location for more than 1 hour within a single daylight period.

Shy Distance: Shy Distance is the measured distance between the edge of traveled way lane marking and the edge of the traffic control device.

Shy Line Offset: Shy Line Offset is the distance from the Edge of the Traveled Way beyond which a roadside object will not be perceived as an obstacle by the typical driver, to the extent that the driver will change the vehicle's placement or speed.

Slow Moving Mobile Operations: Slow Moving Mobile Operations are those that proceed down the roadway at less than five miles per hour (MPH).

Stage: A Stage is a component of work defined by the Design Section Engineer (DSE) or Design-Builder which allows construction for a section of the project while maintaining the same traffic flow.

Stakeholders: Stakeholders are customers directly affected by the project which include Contractor, Construction Manager (CM), Corridor Construction Manager (CCM), Design Section Engineer (DSE), Design-Builder, Illinois Tollway Divisions, outside agencies, Municipalities, and Emergency Responders.

Strip-Map: A Strip-Map is a seamless plan view or other illustration of proposed stage change depicting, but not limited to, construction zone with location of all Maintenance of Traffic (MOT) devices such as: temporary concrete barrier, striping, channelizers, impact attenuators, changeable message signs, ground mounted and overhead signs with text.

Termination Area: The Termination Area is that last portion of the work zone located immediately downstream of the Work Area. It provides an opportunity for traffic to clear the closure and to return to normal traffic lanes. A downstream taper may be located in this area.

Traffic Control Devices: Traffic Control Devices are all signs, lights, signals, markings, channelizing devices and barriers placed on or adjacent to the roadway used to regulate, warn, or guide motorists.

Transition Area: A Transition Area is employed as part of a Work Zone when some form of closure is involved. It is the area in which traffic is moved from one path to another and in which merging, tapering, or weaving, must be accomplished. For lane closing situations, the area is defined as that in which the channelizing taper is contained. The typical devices located in this area are channelizing devices, signs and arrow boards.

Work: Work shall mean the furnishing of all labor, material, tools, equipment, and other incidentals necessary or convenient to the successful completion of the project and carrying out of all duties and obligations imposed by the contract. Work may also be used in context to describe, in whole or in part, the completed facilities to be constructed, altered or removed, as detailed in the Contract.

Work Area: The Work Area is a section within the Work Zone-Activity Area that is set apart for exclusive use by workers and equipment where maintenance, construction or utility operation activities are taking place from which vehicular traffic is prohibited. The terms “work space” and “work site” shall not be used.

Work Zone: The Work Zone is the entire area of roadway that encompasses all traffic control devices and signing that are placed in conjunction with a work activity. It typically starts with the first warning sign such as ROAD WORK AHEAD or ROAD CONSTRUCTION AHEAD and ends with the last sign such as END WORK ZONE SPEED LIMIT (WZSL).

Work Zone Clear Zone: The Clear Zone as defined in Chapter 3 of the American Association of State Highway and Transportation Officials Roadside Design Guide based on the Work Zone Speed Limit (WZSL).

Worker: A Worker is any person engaged in or used for any task present within the work zone.

NOTE:

This manual follows the traditional definitions for **shall**, **should**, and **may**. **Shall** is used to mean something that is required or mandatory, while **should** is used to mean something that is recommended, but not mandatory and **may** is used to mean something that is optional and carries no requirement or recommendation.

SECTION 2.0 PROJECT CONSIDERATIONS

2.1 Relationship to other Manuals/Guidelines

The MOT MANUAL is designed to follow the principles and practices set forth in the Manual on Uniform Traffic Control Devices for Streets and Highways (MUTCD). The procedures established in the MOT MANUAL are tailored to the specific characteristics of the Illinois Tollway and the typical work operations that are performed thereon.

In those instances where traffic control situations or device specifications are not covered in the MOT MANUAL, the provisions of the MUTCD shall apply. For example, the MOT MANUAL addresses only work areas on the Illinois Tollway itself. Where work zones must be established on other highways, such as would be required to make repairs to the underside of an Illinois Tollway bridge over a state highway, the MUTCD defines the procedures to be followed.

When projects involve other agencies, their jurisdiction, policies and procedures must be followed. The MOT plan shall be reviewed and accepted by the involved agencies. When the jurisdictional authority does not have established policies, Illinois Department of Transportation (IDOT) procedures and guidelines shall be followed.

The Illinois Tollway system connects with Interstate Highways serving three adjacent states. To provide consistent traffic control procedures readily recognizable to both in-state and out-of-state motorists, the MUTCD was used as a resource in the preparation of this document.

This MOT MANUAL supersedes the previous "Traffic Control Manual" published by the Illinois Tollway in 1979 and "Roadway Traffic Control and Communications Guidelines" in 2017.

Reference the Illinois Tollway Homepage: Doing Business: Construction and Engineering: Manuals

2.2 Concepts

When project specific MOT plans are not included in the project, MOT Plates included in this MOT MANUAL were created to cover the range of activities commonly performed by Illinois Tollway maintenance and contract forces. In addition, Plates are included which address emergency lane closures.

The intent of the Plates contained herein is to provide a practical balance between the motorist's need for information and the logistical requirements for establishing the work zone while providing both a high level of safety for Illinois Tollway users and protection for workers. This MOT MANUAL recognizes the need for flexibility by Illinois Tollway maintenance crews and contract forces. Illinois Tollway maintenance crews should balance the need for MOT with the need to complete maintenance work. As a result, deviations from this MOT MANUAL may be allowed only with Illinois Tollway Chief Engineering Officer or their designee approval.

Most construction projects are of such duration and magnitude that specific MOT plans will be developed for each project. The principles set forth herein serve as a starting point for this design

process. Recognizing the increased exposure to work zone elements for long-term activities, warrants may exist for more complex types of traffic control.

The MOT Plates for emergency situations consider the lack of advance notice in establishing the work zones and the short duration typically encountered. To provide a practical plan, the number of devices is minimized, but the target value of those devices that are called for is enhanced through the use of flares, or other devices.

As a fee-based transportation system, it is important that extra effort be given to maintaining as free a traffic flow as safety guidelines will allow. It is important also that work zone signing be succinct and concise and be clear and consistent across the system.

2.3 Application

The traffic control procedures set forth in this MOT MANUAL are intended to address typical situations anticipated on the Illinois Tollway. In application, adjustments may be required to fit actual field conditions. If due to space limitations or visibility constraints or other factors it is necessary to use device sizes or spacings that fall below the recommended minimums, then other features should be added to the work zone so that the overall level of safety is maintained.

In those instances where deviations are needed to accommodate field conditions or where operations are to be performed that are not adequately covered by the MOT MANUAL, the traffic control procedure should be discussed with the proper Illinois Tollway personnel prior to undertaking the work.

2.4 Illinois Tollway Traffic Operations and Safety Committee

The Illinois Tollway's Traffic Operations and Safety Committee is utilized to review and approve policy, processes, procedures, and/or guidance for the systematic consideration and management of work zone impacts and related issues, traffic engineering standards and guidelines related to temporary traffic controls, which include the consideration and management of road user and worker safety. The diverse makeup of the members of this committee provides a varied perspective in considering proposals to be implemented:

- Executive
- Communications
- Risk Management
- Safety & Training
- Toll Services
- Legal
- Engineering
- Business Systems
- Illinois State Police (ISP)
- GEC
- Traffic Engineering Consultant
- Program Management Office

These policies, processes, procedures, and/or guidance are based on consideration of standards and/or guidance contained in the MUTCD and the American Association of State Highway and Transportation Officials (AASHTO) Road Design Guide (RDG). The strategies and devices to be used may be determined by either an engineering study, or from Illinois Tollway guidelines that define strategies and approaches to be used based on project and highway characteristics and factors.

SECTION 3.0 PROJECT COMMUNICATIONS

3.1 Information to Report

Information on start of construction, traffic shifts, stage changes, variances, or any other activity that will impact traffic on the Illinois Tollway and/or local roads, as well as nearby communities, must be reported in advance by the Project Communication Liaison (PCL) to the Construction Communications Coordinator (CCC) and the Traffic/Permit Technician at laneclosures@getipass.com. Information about lane closures shall be reported using the guidelines set forth in Article 11.1.4. In addition to lane closure information, any other activity or issues that may impact Illinois Tollway customers should be communicated to the CCC as soon as possible.

Reference Appendix A for further information regarding Construction Communications Roles and Responsibilities.

Reference Appendix B for Traffic MOT Forms.

3.2 Emergency Communication Plan

An approved Emergency Communications Plan shall be established for implementation and to ensure accurate and timely communications of all incidents, MOT related and non-MOT related issues that occur.

Referenced Document: Illinois Tollway Construction Managers Manual (CM Manual), Section 4.7; Communication

3.3 Maintenance of Traffic Advance Coordination Meeting (Mandatory)

3.3.1 Responsibility and Authority

This procedure applies to all personnel preparing, submitting and reviewing MOT stage changes for the Illinois Tollway Projects.

The Chief Engineering Officer is responsible for approving this procedure. The Deputy Chief Program Implementation, has the primary responsibility and authority for implementing and maintaining this Procedure.

3.3.2 21 Day Advance Coordination Meeting

The Project Manager (PM) or Design-Builder schedules a 21 Day Advance Coordination Meeting to be held at the Illinois Tollway and invites all project stakeholders. List of attendees shall include, but is not limited to, the following:

- PM
- Contractor
- CM

- Corridor Construction Manager (CCM) (if applicable)
- ISP District #15
- Illinois Tollway Maintenance
- Illinois Tollway Communications
- Design Section Engineer (DSE) (if applicable)
- Design-Builder (if applicable)
- Business Systems (if applicable)
- Toll Services (if applicable)
- Plaza Supervisor (If applicable)
- IDOT, Outside Agencies & Municipalities (if applicable)
- Local Fire & Rescue (if applicable)

The PM obtains from the CM a strip-map depicting the current stage of traffic, current signing and striping configurations, where traffic will be in the proposed stage change and the proposed changes to signing and striping.

The strip-map will be presented to the project stakeholders. Comments and changes made by the project stakeholders shall be recorded on the strip-map and incorporated into both a revised strip-map and updated MOT plan drawings for final review at the 2 Day Advance Coordination Meeting.

The Contractor is to make and implement any changes directed by the Illinois Tollway at this meeting in order to meet the scheduled stage change date.

Signs which are to be supplied by the Illinois Tollway will be coordinated by the PM with both the CM and Illinois Tollway Maintenance so that preparations can be made to meet the scheduled stage change date.

At least seven days prior to the 2 Day Advance Coordination Meeting, the CM shall gather information for a stage change and any other information to be discussed.

3.3.3 2 Day Advance Coordination Meeting

The PM obtains a revised strip-map from the CM incorporating all of the comments and changes made at the 21 Day Advance Coordination Meeting for final review.

The Contractor, CM and Illinois Tollway Maintenance and Engineering verify that all preparations and changes have been made which meet the intent of the final strip-map plan.

If there is agreement on the revisions, at the conclusion of this meeting the MOT Stage Change Approval Form, which can be obtained from the Web-based Program Management System, is to be signed and the CM develops both the final strip-map and updated MOT plan drawings incorporating all of the approved comments from the project stakeholders.

If not in agreement, the PM shall coordinate the resolution of all outstanding issues and reschedule a follow-up meeting with the appropriate stakeholders so that final approval can be issued

Post Stage Change Evaluation

After the stage change has been implemented, the CM shall inspect and fill out the Traffic Control Inspection Report (Form A-1C) daily; per the guidelines established in the CM Manual Article 4.8.4. The CM makes a statement in the Comments field that all of the MOT devices have been implemented and placed per the approved plan.

The CM uses both the updated MOT plan drawings and the Work Zone Safety Inspection Checklist in Appendix D to verify, in the field, that the approved MOT plan has been successfully executed.

If there are deficiencies noted, a corrective action plan with a timeline for completion is to be submitted by the CM to the PM within 24 hours. The CM is to notify the PM when all corrective actions have been implemented.

The PM will verify that the 21 Day Advance Coordination meeting minutes and 2 Day Advanced Coordination Meeting minutes have been posted by the CM in the Web-Based Project Management System.

3.4 Closure Requests

Lane closures are a last resort. The Maintenance & Traffic Division will make a judgment based on a traffic impact analysis process. The procedures outlined in the Illinois Tollway - Lane Closure Reference Guide shall be followed.

- Nighttime closures are preferred in all cases unless specifically authorized otherwise. Exceptions will be considered on a case-by-case basis. The overriding factor will be minimizing traffic delay as determined by the Illinois Tollway Lane Closure Reference Guide or the Maintenance & Traffic Division.
- Alternate means/methods should be considered in order to avoid or minimize the proposed lane closure.
- If a lane closure is authorized, Contractors shall be prepared to mobilize and initiate work immediately when the lane closure is implemented. Work should be planned such that it can be completed, and the lane closure removed a minimum of a half-hour before the time specified in the contract.
- The Lane closure/traffic impact schedule shall be as compressed as possible with an allowance for an additional time contingency if needed. Weather conditions, crashes, and traffic can sometimes delay the planned completion of a work activity and removal of the lane closure. If the confidence level is not sufficiently high to complete the work within the compressed schedule, then additional time shall be included in the signage/communications/ messaging to account for this possibility. The motoring public generally will tolerate delays if they are warned days in advance. Schedules, travel routes, and times should be planned for accordingly. Unplanned delays cause

significant losses to both commercial and personal time.

3.4.1 10 Day Advance Lane/Shoulder Closure Request

So public notification can be disseminated, the Illinois Tollway Communications Department shall be notified ten (10) days prior to major disruption of traffic, especially for medium or long term duration, start of new construction, major traffic shift, stage change, closing ramps, or whenever construction activity will have a new and significant impact to traffic movements and flow.

Reference: Illinois Tollway - Lane Closure Reference Guide.

3.4.2 Daily Lane Closure Requests & Revisions

Unless otherwise specified in the contract documents, Daily Lane Closure Requests & Revisions are required to be submitted to the Engineer BEFORE 7:00 AM to the Tollway as follows:

- Tuesday work is due Monday BEFORE 7:00 AM
- Wednesday work is due Tuesday BEFORE 7:00 AM
- Thursday work is due Wednesday BEFORE 7:00 AM
- Friday work is due Thursday BEFORE 7:00 AM
- Saturday, Sunday & Monday work is due Friday BEFORE 7:00 AM

If requests are not received BEFORE 7:00 AM on day specified above, they will neither be approved nor published on the Lane Closure Report.

3.4.3 Emergency Closure/Holiday

Emergency closures signed by the PM will be taken on a case-by-case basis. See the Illinois Tollway-Lane Closure Reference Guide and Figure 1 for procedures to be followed.

3.5 Cancellations and Changes

3.5.1 Cancellation of Lane Closure Request

Cancellations of planned lane closures shall be in accordance with procedures of the Illinois Tollway-Lane Closure Reference Guide.

3.5.2 Lane Closure Change Procedures

Revisions to lane closure requests shall be in accordance with procedures of the Illinois Tollway-Lane Closure Reference Guide.

3.6 Reporting Lane Closure Status Procedure

The CM shall contact the Illinois Tollway Traffic Center in accordance with the procedures of the Illinois Tollway – Lane Closure Reference Guide.

3.7 Minimizing Traffic Impacts-Avoiding Conflicts

Project/activities shall be coordinated using a master plan MOT process. Advance project/activity planning and coordination must proceed on a strategic level and must be considered as far in advance as possible. The Management of Traffic planning/permitting levels for projects/activities are as follows:

- Strategic – this involves future year advance planning. Major project conflicts and coordination opportunities are generally identified. Project design and construction details are generally not known. However, projects can be planned and designed to avoid or minimize major disruptions, and project/activity/utility project collaboration can be enabled to maximize cost effectiveness by all involved entities.
- Concept – this involves the project implementation/construction phase. In this case, the project/activity has been designed and the general detail of lane closures/traffic impact activities is known. The actual time periods of lane closures are generally known with good accuracy. This means that the Contractor will have a schedule of closures by month at the start of the project/activity.
- Detail – Contractors and workers are required to provide a detailed closure/messaging plan ten (10) days in advance of the lane closure to allow for review and approval to allow for the Illinois Tollway to provide advance notice and messaging for the general public. The closure/traffic impact plan is specific and accurate to within the hour. Twenty-four (24) hour advance notice is required after the ten (10) day plan/notice is approved. Advance signage and communication between the Contractor, CM, and the Illinois Tollway Incident Manager should have taken place prior to considering the twenty-four (24) hour notice for the lane closure/activity.

REGULAR BUSINESS HOURS Monday – Friday 7 AM to 3 PM

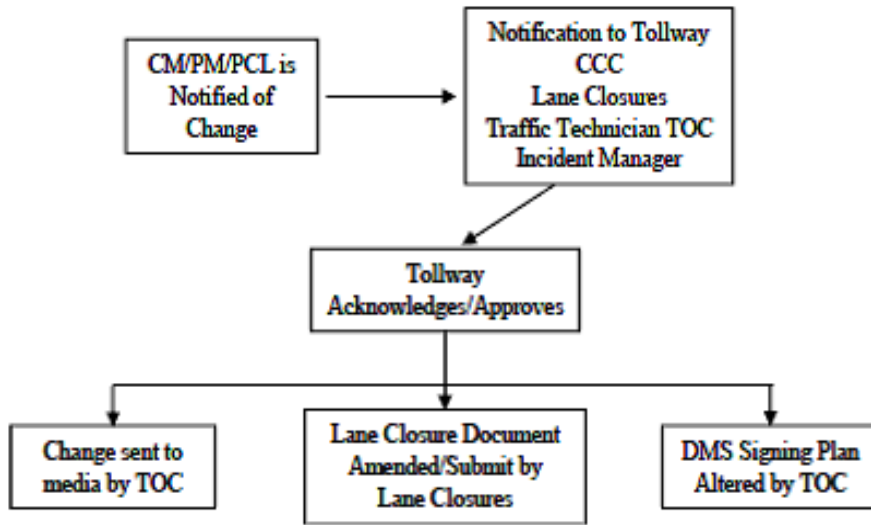

AFTER HOURS + Weekends, Holidays, or 3 PM to 7 AM Monday/Friday

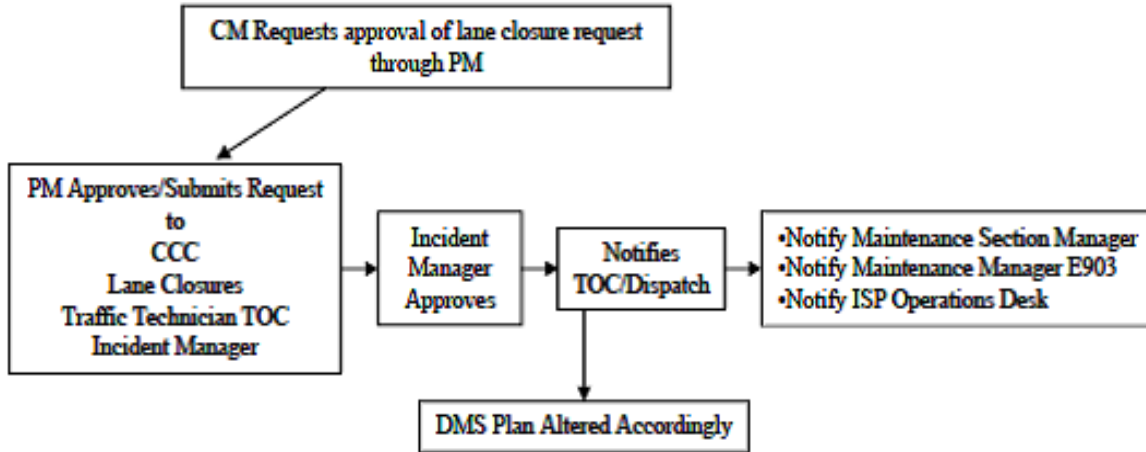

Figure 1 - Emergency Lane Closure Request/or After Hour Lane Closure Changes

SECTION 4.0 PROJECT INFORMATIONAL SIGNING

4.1 Objectives

Provide signing to improve customer awareness (service/experience) through increased communications about roadway conditions, with particular focus on informing motorists about construction projects while motorists are on the roadway and experiencing the inconveniences associated with a project.

Providing accurate information to motorists encourages improved driver attention to conditions.

Typical location of information signs is shown on the Illinois Tollway MOT Standards.

Care must be taken to place project informational signage at locations that do not conflict with construction signage, particularly lane closure or lane shift signage. Changes in construction signage during a project must be coordinated with the Maintenance & Traffic Division to analyze project/activity and special event conflicts for potential conflicts, including conflicting messaging or closure impacts.

4.2 Sign Content

The ground mounted static signs or series of signs should contain the following information:

1. Project benefits
 - a. e.g., I-PASS improvement, drainage, re-surfacing
 - b. Reduce delay
 - c. Improve Ride
2. Duration
 - a. Duration of project: Approximate schedule by month or season if end date is uncertain
3. Length
 - a. Length of project, e.g., Next 5 Miles
4. Effort to minimize disruption
 - a. e.g., Work being done overnight for your convenience, etc.
5. How to get more info and/or provide feedback
 - a. e.g., Comments? Call 1-800-TOLL-FYI (1-800-865-5394)
6. Safety
 - a. Please drive safely
 - b. Please use caution
 - c. Watch for workers
 - d. Other messages related to specific project
7. Thank you
 - a. All messages shall state "Thanks for your Patience"

4.3 Number (in Each Direction) and Type of Signs

The number of signs that will be deployed and the type of signs will be dependent on the type of project, length and expected duration as discussed below.

4.3.1 Major/Long-term Project

Duration greater than 1 month and length greater than 5 miles

1. Dynamic Message Signs (DMS) if in area and available
2. Static shoulder-mounted
 - a. Three (3) at the beginning (Less than three (3) must be approved)
 - i. Project Benefit/Length
 - ii. Duration
 - iii. Working Smart/Thanks
 - b. One (1) in the Middle
 - i. Summary – Project benefit, Duration, Safety and Effort to minimize disruption
 - c. One (1) at the end
 - i. Thanks and Comments
3. Signs should be updated with relevant changes and/or to show progress.
4. Portable Changeable Message Signs (PCMS) (Supplementary)
 - a. Used to guide motorists through work zone
 - b. Provide information that will change frequently

4.3.2 Minor/Medium-term Project

Duration greater than 1 month and length less than 5 miles.

1. DMS if in area and available
2. Static, shoulder mounted
 - a. Two (2) at beginning (if there is room)
 - i. Project Benefit/Length
 - ii. Duration/Safety
 - b. One (1) at end
 - i. Thanks and Comments
3. Signs should be updated with relevant changes and/or to show progress.
4. PCMS (Supplementary)
 - a. Used to guide motorists through work zone
 - b. Provide info that will change frequently

4.3.3 Short-term Project

Duration less than 1 month.

1. DMS if in area and available
2. Shoulder mounted Static Signs
 - a. One (1) at beginning
 - i. Project Benefit/Duration/safety
3. Signs should be updated with relevant changes and/or to show progress.
4. PCMS (Supplementary)

- a. Used to guide motorists through work zone
- b. Provide info that will change frequently

4.3.4 Daily Construction or Lane Closures

Day or night; less than 24 hours.

- 1. DMS if in area and available
- 2. PCMS
 - a. Guide motorists through work zone
 - b. Provide Special information

4.3.5 Project Informational Signs

The size, type and message of the sign shall be determined by the Communications Department.

4.4 Timing of Sign (or Series of Signs) Installations

The Project Information Signs should be erected prior to the beginning of construction activity, but no earlier than two (2) weeks before the start of construction.

PCMS shall be placed prior to the beginning of construction activity no earlier than two (2) weeks, but at least one (1) week before the start of construction. DMS, if available, should be utilized to alert customers of project status.

4.5 Responsibilities

1. The Engineering Department Maintenance & Traffic Division is responsible for overall management and maintenance of the Illinois Tollway system. All activities must be REVIEWED and APPROVED by the Maintenance & Traffic Division. This requirement applies to internal Illinois Tollway Departments and external entities.
2. The Engineering Department shall regularly plan and coordinate with the Communications Department to ensure that the motoring public is adequately informed of planned or on-going traffic impact activities. Regular updates should be provided on all active projects/activities, including projects to be advertised for bid/contracts awarded by the Board. Coordination activities include:
 - a. Upcoming potential lane closures as soon as they are being considered.
 - b. Scheduled lane closure activities that impact traffic.
3. The Engineering Department is responsible for establishing the traffic maintenance plan, signing, and messaging. Working drawings of signing/messaging shall be drafted by the Engineering Department or their representatives. A collaborative review and approval process with the Communications Department shall be used to finalize wording and messaging. Dynamic messaging shall be provided with PCMS and stationary DMS. These signs are managed and maintained by the Engineering Department.
4. The Communications Department is responsible for communications with the general public and most specifically the Illinois Tollway patrons. It is imperative that accurate, up

to date, and consistent information is provided to the Communications Department and most importantly the general public. All project signing/messaging text must be approved by the Communications Department.

5. The CM, CCM and Maintenance & Traffic Division shall keep the Communications Department continuously updated on projects and traffic impact activities.
6. The CM and the CCM shall communicate and coordinate all planned and on-going projects with the Maintenance & Traffic Division to minimize traffic impacts and ensure proper communication with the Communications Department and the general public.

SECTION 5.0 PRINCIPLES OF TRAFFIC CONTROL

5.1 Objectives

The principles of traffic control to be employed on the Illinois Tollway are for the safe and efficient movement of traffic through both maintenance and construction work zones and for the safety of the work force performing these operations.

Motorists have come to expect a high level of service on the Illinois Tollway. The objective is to maintain the highest level of service while considering the safety of motorists and workers alike while providing for the protection of materials, equipment and Illinois Tollway facilities.

Exposure control measures should be considered to avoid or minimize worker exposure to motorized traffic and exposure of road users to work activities, while also providing adequate consideration to the potential impacts on mobility.

Proper traffic control and delineation is critical to achieving safety in work zones. MOT strategies, devices, and contracting/construction techniques and coordination are used to facilitate traffic flow safely through and around work zones. However, the work zone traffic control devices themselves may become an obstacle to vehicle occupants or a danger to work crews when impacted by errant vehicles. Thus, the FHWA and the MUTCD require that the crashworthiness of work zone traffic control devices be demonstrated before they are implemented.

Temporary signs, changeable message signs, arrow boards, channelizing devices and lighting devices are all utilized as temporary traffic control devices. Their placement and positioning must be such as to not present an obstacle to traffic and/or impact any existing traffic barrier device. Temporary installation does not negate the consideration of safety, clear zone, length of need, etc., during the work zone construction duration.

5.2 Definition of Terms

5.2.1 Elements of a Work Zone

To make full and effective use of this MOT MANUAL, one must clearly understand the terms that are used. Many technical words have various meanings in common usage. In this section the definitions given for key terms apply to their specific use in this document.

Reference Article 1.3 of this MOT MANUAL for definitions of terms for Elements of a Work Zone.

It is convenient to subdivide the work zone into a series of “areas,” each of which can be addressed separately during the traffic control design process. Figure 2 shows a typical work zone and illustrates the various elements which compose it:

- Advanced Warning Area
- Transition Area
- Activity Area
- Buffer Space
- Work Area
- Termination Area

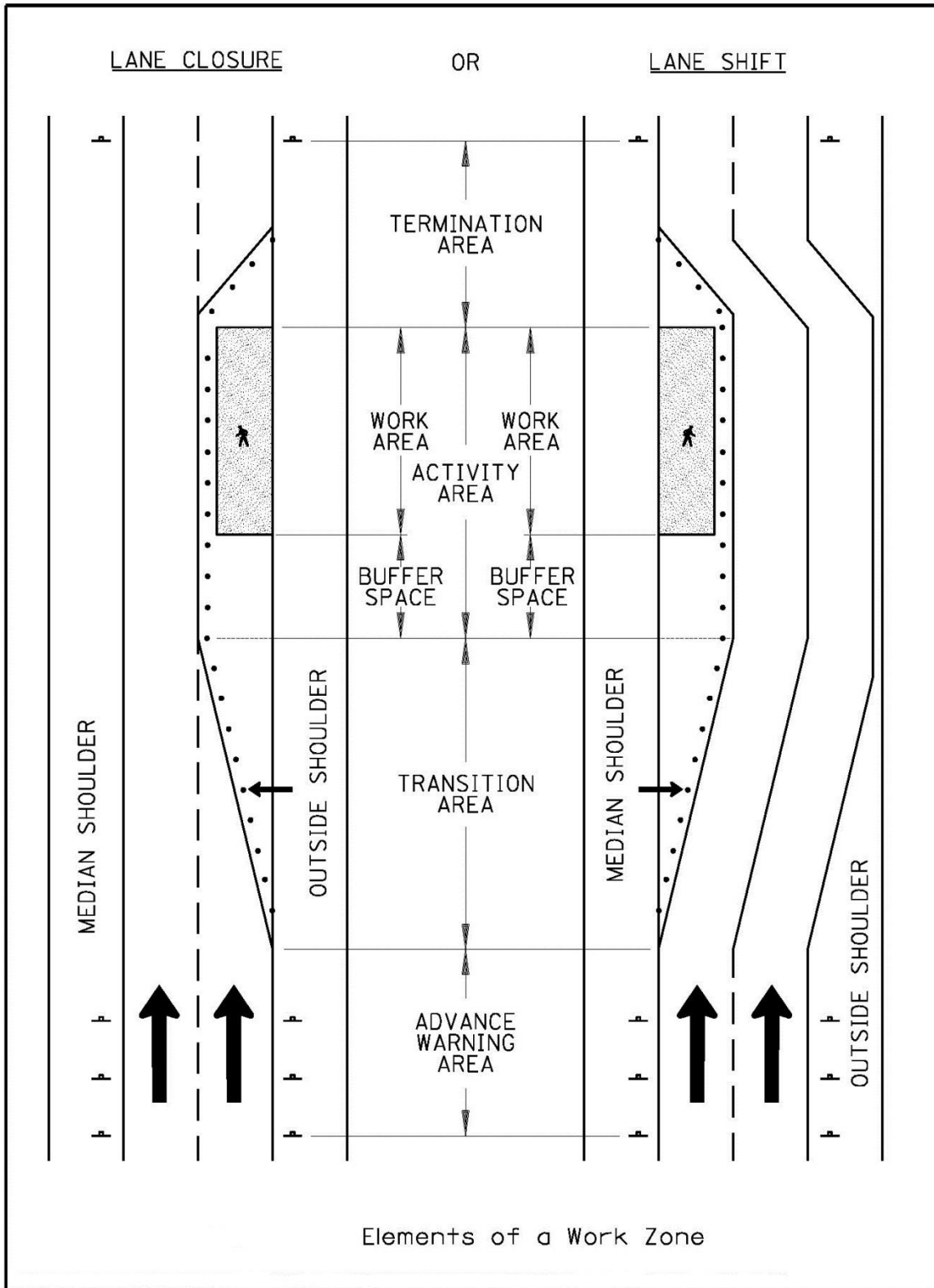

Figure 2

5.3 Considerations

To meet the stated objectives, the sometimes competing needs of motorists and workers must be balanced, and consideration must be given to constraints due to time, costs, field conditions, etc. Effective traffic control design is an optimization process.

There are considerations that when applied mitigate the effects of compromise and constraint which enhance the attainment of the traffic control objectives. Among the principles to be employed are uniformity, adaptation, compensation and redundancy.

5.3.1 Work Zone Safety and Mobility

5.3.1.1 Work Zone Safety

Equally as important as the safety of road users traveling through the work zone is the safety of the workers. Work zones present temporary and constantly changing conditions that are unexpected by the road user. This creates a high degree of vulnerability for workers on or near the roadway.

The following are some of the important elements of worker safety and work zone management that should be considered to improve safety:

- Worker Training
- MOT Plans
- Compliance with Standards
- Use of Positive Protection, Reference: Section 7 of this MOT MANUAL.
- Work Zone Speed Limit (WSZL)
- Enforcement
- Activity Area
- Flaggers
- Access to Work Zone

5.3.1.2 Work Zone Mobility

Work zone mobility refers to the movement of road users efficiently through a work zone without compromising the safety of highway workers or road users with minimum delay compared to travel when no work zone is present. The commonly used performance measures for the assessment of mobility include delay, speed, travel time, and queue lengths.

MOT strategies must include a plan to notify road users, as well as mitigate and manage the congestion as much as possible. Traffic capacity mitigation measures are important since many projects cannot effectively eliminate all work zone impacts. A capacity analysis helps determine whether a work zone strategy is feasible. Mitigation measures that provide the optimal combination of public information, and advance signing and notification can be effective in reducing mobility impacts. Other innovations such as strategic closures, and accelerated construction schedules also aid in this.

5.3.2 Work Zone Speed Limit

5.3.2.1 Managing Speeds in Work Zones

Traffic speed in highway work zones is an important factor affecting the safety for both the traveling public and for the workers during construction or maintenance activities. Determining the safest and most efficient speed limit within work zones based on roadway conditions should provide for a consistent and efficient traffic flow. Proper and consistent application of the WZSL should improve the safety of the highway worker and the traveling public, allow for better enforcement, and minimize traffic congestion and incidents, all of which will contribute to a safer work zone.

An enhanced understanding of the relationship between factors used to justify reduced WZSL and motorist perceptions of the need to reduce their speed should improve the speed limit selection process and compliance of speed limits within the work zone. The document “Guidelines on Managing Speeds in Work Zones” developed by the Roadway Safety Consortium summarizes available guidance on setting speed limits and managing speeds in work zones.

Website path to this publication: <https://www.workzonesafety.org/publication/guidelines-on-managing-speeds-in-work-zones-2/>

AASHTO members and other highway construction industry experts identified the need for guidance on managing speeds in work zones. A fundamental principle of temporary traffic control is that road user movement should be inhibited as little as practical. The MUTCD states that reduced speed limits should be used only in the specific portion of the work zone where conditions or restrictive features are present. These guidelines have been developed to provide the Designer with typical factors to consider and evaluate in determining a WZSL.

Speed is often regarded as an indicator or measure of two different transportation performance characteristics, mobility and safety. Higher speeds generally translate to shorter travel times, an indication of good mobility. The relationship between speed and safety is complicated and indistinct. One of the many complicating factors is that high-speed highways have low crash rates. However, since interstate highways also have distinguishing design features (e.g., limited access control and wide clear zones), it is difficult to separate the effects of speed from other characteristics. Therefore, conflicts can develop between the mobility and safety objectives.

The Illinois Tollway operates as a high-speed facility. Slower speeds in work zones may reduce the roadway capacity and cause localized congestion, which, in turn, can increase the potential for rear-end crashes and other conflicts, such as vehicles maneuvering out of their travel lane. While the speed of traffic can affect crash frequency and severity, speed variance is also an important factor. ***Traffic moving along at a uniform pace, albeit somewhat faster, may be safer than traffic moving at slower, non-uniform speeds, which increases the potential for conflicts between vehicles¹.***

Drivers are informed that they need to slow down in work zones through the use of signing, lane striping, reduced speed limits and other techniques. Regulatory speed limit signs are used to inform drivers of the legal speed limit in a work zone. When normal operating speeds on the roadway are high, voluntary speed reductions may not produce the desired speeds through the work zone. Simply posting lower speed limits does not necessarily reduce speeds. Numerous

¹ Guidelines on Managing Speeds in Work Zones.

studies have shown that posting a reduced speed limit sign by itself does not slow drivers down. Drivers reduce their speeds through the work zone only when they perceive a need to do so, based on conditions in the work zone or the perception of enforcement activities. Typically, drivers slow down when large equipment and workers are located close to moving traffic, when roadway restrictions such as temporary crossovers or narrowed lanes are in place or when temporary traffic barriers are near the edge of the lane. ***It is the situation they see, and not the reduced speed limit sign itself, that causes drivers to reduce their speeds².***

The following is a list of referenced publications in which variable speed limit systems in a work zone have been studied.

- A Field Test and Evaluation of Variable Speed Limits in Work Zones; U. S. Department of Transportation Federal Highway Administration
- Safe Speeds in Work Zones; FHWA Publication No: FHWA-RC-BAL-04-0015
- Field Test of Variable Speed Limits in Work Zones (Michigan), Final Report RC-1467, U. S. Department of Transportation Federal Highway Administration
- Variable Speed Limit Signs Effects on Speed and Speed Variation in Work Zones; Utah Department of Transportation
- Work Zone Variable Speed Limit Systems: Effectiveness and System Design Issues; Virginia Transportation Research Council
- Evaluation of Work Zone Speed Limits: An Objective and Subjective Analysis of Work Zones in Missouri; Missouri University of Science and Technology
- Exploring the Effectiveness of Variable Speed Limit Controls on Highway Work-Zone Operations; University of Maryland
- A Framework to Evaluate the Impact of Variable Speed Limit Systems on Work Zone Traffic Operation Using VISSIM; DKS Associates

5.3.2.2 Determination of Work Zone Speed Limits

Establishing WZSL is based on sound engineering judgment being applied while examining various aspects of the project. Many varying factors include considering scope of work, MOT, geometrics, construction access/egress, project length and duration, and traffic volume. etc., are to be considered in determining the appropriate WZSL. It is important to understand that overuse of speed limits, especially speed limits that are unrealistically low, will have little effect in reducing speed in the work area. As a negative consequence, it will create driver disrespect for WZSL in general, and will thus adversely affect speeds at other sites where speed limits are posted realistically.

The Illinois Vehicle Code under Sections 11-605.1 gives to the Illinois Tollway the authority to alter maximum posted speed limits on its system for establishing a construction or maintenance speed zone.

Normal Posted Speed

70 miles per hour (MPH)	Maximum WZSL:	65 MPH
≤ 65 MPH	Maximum WZSL:	Posted Speed
ALL	Minimum WZSL:	45MPH

² Ibid

Condition based speed limits are to be used to manage WZSL. These are determined based on the varying work zone conditions. Some work zone conditions to evaluate are:

- Managed Work Area
- Stage Changes
- Access to Work Area
- Use of Shoulder
- Construction Work Equipment
- Pull-Out Area
- Type of Traffic Control Device
- Duration of Work
- Restricted Work Hours

The applicable WZSL reflects some of the same factors a prudent driver also considers. Improving the consistency between a responsible driver's speed selection and the speed limit may help to restore WZSL credibility and improve safety.

Reduced speed limits should remain in place only when work zone conditions present a controlling concern. Failure to adjust these signs when they are not needed leads to reduced credibility of speed limits, decreased compliance with speed control and other temporary traffic control devices in the work zone, greater variation in vehicle speeds, and negative public opinion of work zones. In order to maintain the credibility of WZSL, signs used to reduce speeds should be adjusted as conditions warrant.

Condition based speed limits are not common to most Illinois Tollway projects. However, there are projects whereby this strategy can be utilized.

- Example 1: Pavement Markings. The WZSL is kept at posted during the daytime and reduced at nighttime during construction operations.
- Example 2: Intermittent Patching. The WZSL is kept at posted during the daytime and reduced at nighttime during construction operations.
- Example 3: Long work zones. The WZSL is kept at posted until construction operations have been scheduled for a specific roadway segment.

WZSL signs shall be placed according to Illinois Tollway Standards, beyond the entrance ramps associated with each interchange, and at the approximate midway point within the work zone length. WZSL sign spacing is not to exceed 5 miles.

The Illinois Tollway has developed WZSL flow charts for some of the more common work zone situations encountered, considering MOT, type of traffic control devices, shoulder refuge, along with managed work areas. These charts cannot cover every situation that may be encountered in construction and maintenance work zones and should serve as a baseline or starting point. There are many factors that can come into play that are not covered in these guidelines which may justify the use of a recommended WZSL. The WZSL flow charts are to provide decision tools to assist Designers with managing speeds in work zones. Engineering judgment, as well as state laws and practices, should be used to determine the appropriate speed limit, speed limit management strategies and speed reduction strategies for each work zone. For several situations, the desired WZSL will offer a range in speed limits for consideration.

Reference Appendix F-Flow Charts for Consideration of Work Zone Speed Limits.

The starting point in determining the WZSL is to consider the following:

Posted Speed 65 MPH or Greater: Desired WZSL 55 MPH

Posted Speed 55 MPH: Desired WZSL 50 MPH

Shoulder Closure Posted Speed: Any Desired WZSL 55 MPH

Reduced speed limits should be used only in the work zone where conditions or restrictive features are present. Frequent changes in the speed limit are not permitted. A desirable MOT plan should be designed so that vehicles can travel through the work zone with a minimal speed limit reduction. An explanation is required for establishing a WZSL less than the desirable. Where restrictive features justify a speed reduction of more than 10 mph, additional driver notification should be provided. The speed limit should be stepped down in advance of the location requiring the lowest speed, and MOT warning devices should be used in accordance with Illinois Tollway Standards.

Use of Flowcharts

1. Select Roadway Configuration
2. Determine MOT Type
3. Duration of Work
4. Traffic Control Device Used
5. Is there a shoulder available for vehicle refuge?
6. Has the work zone been managed for safest and most efficient speed limit?
7. Select (or) propose alternate WZSL
8. Complete WZSL Form

MOT Modified is the condition when traffic is in lanes not using a shoulder.

5.3.2.3 Work Zone Considerations

Work zone considerations are those factors which establish the basic framework in establishing condition-based WZSL.

The design and physical factors of the roadway place a definite limitation on the safe operating speed of vehicles. These factors along with type of construction and the MOT features are to be taken into consideration in the establishing WZSL.

Actual project conditions used to establish the WZSL are numerous and highly variable. Speed limit strategies are justified for certain conditions, and optional for others, based on a careful engineering analysis of project-specific criteria.

The Illinois Tollway has incorporated adjustments into the MOT Standards-Section E to accommodate various WZSL. However, the Designer needs to evaluate whether unique work zone features of a specific project would require a plan detail.

5.3.2.3.1 Segmented Work Zone

In some cases, it may be desirable to establish different speed zones within an individual project. Though this is uncommon, dependent on the type of construction activities, long work zones with

staged construction activities can incorporate shorter lengths of lane closures, thus increasing mobility. Whenever possible, the use of short-segmented work zones is desirable. The maximum length of lane closures should be 5 miles with at least 3 miles between adjacent work areas unless documentation shows that a longer length minimizes road user costs, or substantially shortens the overall duration of a lane closure.

5.3.2.3.2 MOT Complexity

In the design of a project, the MOT plan is an essential element in determining a method for maintaining a safe flow of traffic through a construction work zone. The different types of traffic patterns required to allow for the construction activity will have an impact on the recommended WZSL. Likewise, the selected WZSL may impact the features of the MOT. Illinois Tollway Standard E4 provides tables for MOT reverse curve layout based on WZSL. Higher speeds necessitate extending the buffer space which is located immediately in advance of the Work Area to provide additional recovery space for an errant vehicle that may penetrate the taper in the Transition Area. Illinois Tollway Standard Drawing E2 (Lane Closure Details) provides a minimum buffer space of 650'.

The work zone presents a dynamic work environment with changing conditions. Each MOT stage may introduce a new construction activity, duration, traffic pattern, or traffic control device. The WZSL needs to be evaluated for each MOT stage for the proposed work zone design layout. These varying conditions may result in changes to the WZSL.

5.3.2.3.3 Refuge Area

An important feature to consider is the available space provided for a disabled vehicle. When the shoulder area becomes less than 8' in width there is insufficient area for a vehicle to find refuge. This condition often dictates providing an area within the Work Zone for vehicle refuge, designated as a "Pull-Out Area" herein. Shoulders that are between 4' and 8' wide shall be striped with diagonal shoulder striping according to Illinois Tollway Standard D5.

Pull-Out Areas are discussed in Article 5.3.7.

5.3.2.3.4 Potential Roadside Obstacles

The clear zone is the unobstructed, traversable area provided beyond the edge of the through traveled way for the recovery of errant vehicles. Within the work zone, traffic may be shifted onto the shoulder reducing the effective offset distance to an existing obstacle. Also, the contract may introduce temporary obstacles (i.e., temporary lighting) requiring the clear zone distance to be evaluated.

The AASHTO RDG provides guidance and Table 3-1 provides suggested Clear Zone Distances based on traffic volumes, speeds, and roadside geometry. As stated in the Illinois Tollway TBG, the highest value within the range from Table 3-1 shall be used. Based on the selected WZSL, temporary roadside barrier may be required to shield an obstacle.

Reference Documents: AASHTO RDG, Illinois Tollway TBG

5.3.2.3.5 Construction Access/Egress

Unless otherwise specified in the contract documents, the Contractor access to work area locations are proposed by the Contractor and submitted to the CM for acceptance prior to placement. Construction vehicles entering or exiting the work area can create significant speed differentials between themselves and traffic using the facility. The Illinois Tollway has developed Standard Drawing E6 for the required features of this access point which has been detailed for a range of WZSL. When higher speed limits are utilized, additional opening length may be required to accommodate the deceleration and acceleration of vehicles exiting and merging with through traffic. For site specific locations, there may not be adequate room for this placement. It is essential that the Designer take into consideration the construction phases, staging, number of anticipated access points, and work area restrictions which may impact the flow of construction vehicles, equipment, and workers operating in the work zone.

Construction Access/Egress is discussed in Article 5.3.5.

5.3.2.3.6 Roadway Capacity-Volume

The Illinois Tollway system operates on two, three and four lane roadway segments. An important feature to evaluate in developing the WZSL within an MOT plan is the effect on roadway capacity and number of lanes impacted by the type of construction or maintenance operation.

The Illinois Tollway Lane Closure Guide provides lane closure sheets to the Designer with the hours of the day and days of the week when the traffic impacts of a lane closure are expected to be within acceptable limits. The numbers of lanes available at that time on all sections are provided. Thus, the presented volumes are an estimate of actual demand on available lanes, which is the most relevant information for assessing potential lane closures.

Typically, during nighttime hours, the traffic volumes are significantly reduced on the Illinois Tollway systems. Additional lanes are available to be taken out of service without impacting roadway capacity. Also, with reduced traffic volumes during various time periods, the WZSL may accommodate a speed above 45 MPH.

Reference Document: Illinois Tollway Lane Closure Guide; Illinois Tollway Website

5.3.2.3.7 Roadway Geometry

Horizontal and vertical alignments establish the general character of a highway, perhaps more than any other design consideration. The configuration of line and grade can affect a recommended WZSL and sight distances. The roadway geometry along with the work zone MOT can be controlling elements in the selection of a WZSL. Other criteria require that judgments be made by Designers in consideration of site-specific work zone conditions and activities.

5.3.2.3.8 Sight Distance

To maintain vehicle paths and avoid conflicts, drivers need adequate visibility of road and traffic conditions. Visibility needs are related to the operating environment and vehicle speeds. AASHTO's A Policy on Geometric Design for Highways and Streets, "Green Book", identifies several types of sight distances and establishes minimum design values. Sight distance requirements depend on both the horizontal alignment and the vertical alignment (or profile) of the roadway.

5.3.2.3.9 Interchanges

The number and location of interchanges, and the exit-entrance ramp locations within the construction work zone may have an influence on the recommended WZSL for a given segment within the work zone. The volume of vehicles either entering or exiting the roadway may be impacted by the MOT configuration. The length of entrance-ramp acceleration lanes, exit-ramp deceleration lanes, and taper rates need to be considered. A design objective should be to minimize the speed disparity between mainline and entering/exiting traffic streams.

Reference: Chapter 10 of AASHTO's A Policy on Geometric Design for Highways and Streets.

5.3.2.3.10 Shoulder Closure

Shoulders provide a number of important functions. Safety and efficient traffic operations can be adversely affected if any of the following functions of shoulders are compromised:

- Emergency storage of disabled vehicles.
- Space for enforcement activities.
- An area for drivers to maneuver to avoid crashes.
- A stable, clear recovery area for drivers who have left the travel lane.
- Improve stopping sight distance at horizontal curves by providing an offset to objects such as barrier and bridge piers.
- On roadways with gutter and enclosed drainage systems, store and carry water during storms, preventing water from encroaching onto the travel lanes.
- On high-speed roadways, improve capacity by increasing driver comfort.

When a shoulder closure is required to perform construction or maintenance work, the roadway configuration plays a significant role in establishing the WZSL. The roadway configuration for a two-lane roadway differs significantly from three and four lane configurations for the shoulder widths. A two-lane roadway's median shoulder is 4' wide, while three and four lane roadways' have median shoulder widths of 11.5' or 12'.

When shoulder closure lengths exceed 1000', the WZSL should be evaluated depending on type of traffic control device utilized.

During winter months, the use of permanent shoulder closures should be avoided.

5.3.2.3.11 Work Area

The length and location of the work area is to be considered in establishing a WZSL. Work areas requiring a lane closure or traffic shift differ if these involve a shoulder closure. Each MOT configuration, along with the type of traffic control device utilized can influence the WZSL selected.

5.3.2.3.12 Active Work Zone

The condition of a work area when construction operations are actively in progress, where workers are present, may become a factor for a recommended WZSL. However, the presence of workers alone is not a controlling factor.

5.3.2.3.13 Adjacent Projects

Coordination with adjacent project(s) is very important. The WZSL established on an ongoing project may impact and influence the recommended value for use on an adjacent one being designed. It is important to establish a safe and effective WZSL for the efficient movement of traffic along the entire affected roadway segment.

5.3.2.3.14 Work Zone Speed Limit Responsibilities

The following are the general responsibilities of the involved parties:

Designer Responsibilities

The Designer must submit the Illinois Tollway's Work Zone Speed Limit Form for each project. The submittal should be early in the design process so that the necessary details can be incorporated into the plans. A separate WZSL Form is to be submitted for each MOT stage for each affected roadway. MOT plan configurations should also be included.

WZSL Form submittal process:

1. DSE or Design-Builder prepares and submits to Design Corridor Manager (DCM)
2. DCM reviews and sends to PM
3. PM reviews and sends to WZSL Committee
4. WZSL Committee may request meeting with DSE or Design-Builder concerning any questions/issues.

Reference Documents:

- Appendix F-Flow Charts for Consideration of Work Zone Speed Limits
- Illinois Tollway WZSL Form-WBPM, Folder-Traffic MOT

Design Corridor Manager / Construction Corridor Manager

For corridor projects, both Design and Construction Corridor Managers need to review, evaluate and coordinate WZSL to be utilized during the construction stages between individual projects.

WZSL Committee

The WZSL Committee will review the WZSL Form, supporting documentation, and proposed WZSL. When there is not a unanimous agreement for the proposed WZSL for a particular project, a separate meeting will be conducted to discuss the MOT and develop consensus.

WZSL Committee Members

- Illinois Tollway- Incident Manager
- Illinois Tollway- Roadway Maintenance Manager
- Illinois Tollway- Traffic Operation Manager
- Illinois Tollway- Geometrics Engineer
- ISP
- Illinois Tollway General Engineering Consultant (GEC)-Committee Point Person

Contractor Responsibilities

When the Contractor proposes changes to the contract plans, the Contractor shall submit any proposed revisions to the MOT and WZSL to the WZSL Committee for review. Reference Article 2.4; Designer Responsibilities for additional guidance.

5.3.2.3.15 Ramps - Work Zone Speed Limit*Service Interchange
Diamond/Outer/Loops*

The Illinois Tollway does not post regulatory speed limits on ramps. The Illinois Tollway may post an Advisory Speed (W13-1P) plaque to supplement a warning sign to indicate an advisory speed based on the ramp design speed.

However, when work is being performed on a ramp, the Designer may consider posting an Advisory Speed (W13-1P) plaque to supplement a warning sign to indicate an advisory speed for a specific construction condition.

*Directional Ramps
Collector-Distributor Roadway
Service Interchange-Directional*

Ramps with a design speed of 50 MPH or greater may consider establishing a WZSL when its length exceeds ½ mile.

The Designer shall submit the WZSL Form to the WZSL Committee for review.

5.3.3 Work Zone Trooper Assistance

When allowed by the Contract, ISP assistance is required for any full stops on the Illinois Tollway System. Requests for trooper assistance shall be submitted in accordance with the Illinois Tollway Lane Closure Reference Guide.

5.3.4 Work Zone Clear Zone

Chapter 3 of the AASHTO RDG (2011) defines a clear zone as “The unobstructed, traversable area provided beyond the edge of the through traveled way for the recovery of errant vehicles.” In accordance with Article 9.1 of the AASHTO RDG (2011), “The forgiving roadside concept...should be applied to all work zones as appropriate for the type of work being done and to the extent existing roadside conditions allow, where appropriate. This includes providing a clear recovery area for longer-term projects and using traffic control devices and safety appurtenances that are crashworthy or shielded.”

In determining and establishing the clear zone for a project’s work zone, the designer must consider several factors that together contribute to the selection of clear zone for the work zone.

This section of the MOT MANUAL should be considered in coordination with the MUTCD, AASHTO RDG, and other sections of this document particularly the Illinois Tollway’s Longitudinal Drop-off Policy and Use of Positive Protection Devices. The information included herein is meant

to provide the designer with information and topics for consideration when evaluating the clear zone.

Engineering judgment using the guidelines set forth herein, the MUTCD, and the AASHTO RDG must be employed for the clear zone determination due to the number of variables associated with each work zone. Work operations that are actively in progress, or objects that are delineated by approved traffic control measures are not generally subject to the clear zone requirements for work zones.

Factors that must be considered when establishing a clear zone for a work zone may include:

- Duration of the construction activity(ies)
- Traffic volumes
- Nature of the potential obstacle
- Longitudinal edge drop-offs
- Use of positive protection
- Design speed through the work zone and anticipated running speeds
- Length of the potential obstacle
- Proximity between traffic and construction workers
- Proximity between traffic and construction equipment and temporary structures (scaffolding, bracing, piling, etc.)
- Geometry of the roadway
- Transition areas through the work zone
- Lane closures or lane transitions
- Type and location of equipment and material storage

When potential roadside obstacles are determined to be located within or in close proximity to the clear zone, they should be further evaluated utilizing the procedures and principles outlined in the Illinois Tollway's TBG. This process should be documented by the Designer and implemented into the contract documents, including but not limited to the MOT plans and specifications.

5.3.5 Contractor Access to Work Area

Contractor access to work area locations, when MOT plans are prepared, shall be determined by the DSE or Design-Builder. For projects that do not include detailed MOT plans, access locations, as needed, shall be proposed by the Contractor and submitted to the CM for acceptance prior to any placement. Flaggers are to be positioned to alert through traffic of construction equipment and vehicles entering and/or exiting the work area and to minimize impacts on through traffic in the work zone. Minimum distance must be maintained from crossovers, exit and entrance points, and ramps to allow for safe and efficient traffic movement.

Contractor Access to Work Area shall be spaced no closer than 2,600 feet between areas, except for bridge work where two access locations may be provided, one on each side of the structure. However, at bridges only one access area at a time will be allowed to be opened for use. The locations for Contractor Access to Work Area shall meet minimum stopping sight distance requirement in accordance with the AASHTO Green Book (current edition).

Reference Document (Current Edition): Illinois Tollway Standard Drawing E6.

5.3.6 Stabilized Construction Entrance

A stabilized construction entrance, as needed, is to be installed at the point of entrance/exit to a construction work area which utilizes a pad of aggregate underlain with a geotextile material, unless otherwise specified. The purpose of this installation is to reduce the tracking of mud and dirt onto the Illinois Tollway and public roads by construction vehicles. Reducing tracking of sediments and other pollutants onto paved roads helps prevent deposition of sediments into local storm drains or surface waters and production of airborne dust.

The National Pollutant Discharge Elimination System (NPDES) permits require that appropriate measures be implemented to prevent the tracking of sediments onto paved roadways.

Reference Document (Current Edition): Illinois Tollway Standard Drawing K1.

5.3.7 Pull Out Areas

Roadway cross-sectional width is often reapportioned in work zones, resulting in the reduction or elimination of shoulders and travel lanes. Since shoulders are the traditional refuge for disabled vehicles, operators of disabled vehicles may be faced with unfamiliar conditions and undesirable choices. The provision of emergency pull-out areas mitigates cross-sectional reductions. The provision of enforcement pull-out areas offers additional means of facilitating work zone enforcement.

Emergency and enforcement pull-out area locations are needed and are to be proposed by the Designer and shown on the contract MOT Plans. Emergency pull-out areas shall be spaced approximately $\frac{1}{2}$ mile between locations when shoulders are less than 8 feet wide for a length of more than $\frac{1}{2}$ mile. Enforcement pull-out areas shall be spaced approximately 3 miles between locations. Consideration shall be given to the project length, access or limitations to existing shoulders during construction, and proximity of the start or end of the project, any of which could be used for either enforcement activities, disabled vehicle storage or other emergency response activities.

The locations for emergency and enforcement pull-out areas shall meet minimum stopping sight distance requirement in accordance with AASHTO Green Book (current edition). Sight distance is an important consideration in pull-out location selection and design. Extended sight distance aids driver performance in resolving potential conflicts between traffic in the through lanes and traffic that is entering or exiting an emergency pull-out area. Pull-out areas shall be on relatively flat, tangent sections of the roadway to maximize available sight distance.

Emergency pull-out areas should be located on the right side of the travel lanes. Left-side pullout areas violate driver expectancy and should only be used where the right side is not available. When counter flow lanes are implemented, it may become necessary to have emergency pull-outs located on the left side of traveled lanes. Enforcement pull-out areas should only be located on the right side of the travel lanes.

Advance construction guide signing improves the use and safety of pull-out areas. By knowing the distance to a refuge, drivers experiencing emergencies can make informed decisions on the approach and exit maneuvers. Signing also provides other drivers with notice of potential exiting and merging traffic.

Reference Document (Current Edition): Illinois Tollway Standard Drawing E7.

5.3.8 Lane Closure

Lane closure is a construction work zone mitigation strategy wherein one or more travel lanes and any adjacent shoulders are closed to traffic. Typically, lanes are not permanently closed on the Illinois Tollway; the existing lane capacity is maintained with the use of a lane shift.

Condition: When workers or equipment are present in the work area and encroach within 2 feet or less from the edge of traveled way, the lane open to traffic shall be temporarily closed during work activities.

Guidance: This mitigation may require nighttime work depending on system location. Also, dependent on the scope of work, constructability and duration, the use of positive protection devices should be assessed as a possible alternate to lane closure.

Lane closures/traffic impact activities shall be immediately discontinued if the Engineering Department determines that unacceptable and/or unplanned traffic impacts have resulted. Lane closures should be removed immediately if there is no appreciable work activity being accomplished. The motoring public is generally intolerant of lane closures/traffic impact activities if there is no visible sign of activity or progress. The Maintenance & Traffic Division has the authority to approve and remove lane closures/traffic impact activities at its discretion. The Deputy Program Manager and each Project Engineer/Manager has a responsibility to proactively manage their projects to ensure proper procedures are followed and that the goals/intent of this MOT MANUAL are achieved.

Traffic conditions, crashes, rain, snow, fog, and other unforeseen emergency conditions may require the CM to restrict, modify, or remove lane closures or channelization shown in the plans.

Reference Document (Current Edition): Illinois Tollway Standard Drawing E2.

5.3.9 Interior Lane Closure

Interior lane closure which creates a split traffic pattern is discouraged from use on the Illinois Tollway, however this work zone mitigation strategy may be necessary for certain circumstances. Prior approval from the Illinois Tollway Maintenance is required for this traffic pattern. A project specific MOT traffic plan must be developed for implementation. A minimum of 2 sets of Type 3 diagrammatic signs with supplemental plates indicating any resulting access restrictions shall be provided in advance of the split configuration.

Reduced spacing of traffic control devices (25' centers preferred) shall be specified to prevent vehicles from crossing through the work zone, with use of positive protection devices considered at locations with high probability of crossovers, such as exit ramps.

Reference Section 11, Figure 5 Interior Lane Closure Installation Procedure

5.3.10 Tapers

Tapers are used to move traffic laterally from one path to another. Tapers are typically formed by using an array of channelizing devices. The following are different types of tapers which may be used in work zones.

1. Merging Taper - A merging taper is used on multilane roadways when the number of traffic lanes are reduced. Merging tapers require longer distances to enable traffic to adjust their speed and to find a gap to merge into a single lane before the end of the transition.
2. Shifting Taper - A shifting taper is used for a lateral shift and not merging. The shift can be accomplished using relatively flat tapers of 65:1 for approaches and departures on mainline.
3. Shoulder Taper - When a shoulder is closed on a high-speed facility, it should be treated as a closure of a portion of the roadway, and the work area on the shoulder should be preceded by a shoulder taper. Shoulder tapers may be needed when the shoulder is unavailable for use.
4. Downstream Taper - A downstream taper is an optional feature which may be placed in the termination area immediately downstream of the work area. It is used to direct traffic back into a lane which has been closed in the work area. Because such tapers do not force traffic to shift laterally, they may be relatively short, a minimum of 100 feet. Downstream tapers are particularly useful where there are ramps located in close proximity just beyond the work area. They may be undesirable where trucks need to back into the work area or need to accelerate up to merging speeds upon leaving the work area.
5. Two-Way Traffic Taper - The two-way traffic taper is a special taper which is used in advance of a work area that occupies part of a two-way roadway. The remainder of the road is used alternately by traffic in either direction. Such tapers are not used on the Illinois Tollway mainline roadway, but may be used on service drives and access roads or on highways which the Illinois Tollway crosses over/under. The function of this taper is not to force traffic to merge, but rather to resolve the potential head-on conflict. A short taper is used to cause traffic to slow down by presenting the appearance of a restricted alignment. Flaggers are used to assign right-of-way in such situations. When implementing such tapers on cross-roads, the appropriate IDOT or jurisdictional agency standards should be used.
6. Reverse Curve- A single or multilane traffic flow operation in which traffic is shifted laterally right to left or left to right through two successive curves. Commonly used to redirect through lanes at median crossovers, this measure shall only be used within a work area.

Reference Document (Current Edition): Illinois Tollway Standard Drawing E4

5.3.11 Counter-Flow Lane

Counter-flow is a construction work zone mitigation strategy to establish two-way traffic on a normally divided roadway facility. This strategy allows for the construction of a larger segment of the one-way roadway with reduced conflict between roadway traffic and equipment, workers, or onsite material movement.

This strategy involves:

- The number of lanes in each direction are to remain the same as existing.

- At both ends, one or more traffic lanes in one direction is routed across the median to the opposite-direction pavement or roadway. At some locations median barrier wall is removed or a temporary crossover is constructed for this purpose.
- No truck traffic is permitted to use the counter flow lane, when only one lane is moved to the opposite side.
- Evaluation of traffic volumes to determine if cross-overs between counter-flow lanes and local lanes are needed to optimize traffic flow.

Crossover locations shall be selected which maintain existing access points. Additionally, substantial grade differences between the one-way roadways or within median topography can influence the feasibility and cost of a temporary crossover roadway. The design must address horizontal geometry along with vertical profile and cross slopes when selecting locations. Type 3 diagrammatic signs with supplemental plates indicating any resulting access restrictions shall be provided in advance of crossovers.

Counter-flow lane use imposes more constraints on drivers. There is usually only a single one-way lane, which limits driver lane and speed choice. Additionally, cross-sectional arrangements often involve operations near barriers and reduce refuge opportunity for disabled vehicles, requiring the placement of emergency pull-out areas.

5.3.12 Use of Shoulder

Use of shoulder is a construction work zone mitigation strategy involving the use of an outside or median shoulder as all or part of a temporary traffic lane. This strategy compensates for the removal of permanent travel lanes from service. Employing this strategy may require constructing or upgrading shoulder pavement structures to adequately support traffic loads and maintain minimum lane width requirements. For Long Term Stationary projects, the shoulder rumble strip should be removed and replaced with hot-mix asphalt (HMA) for the duration of the work, and restored once the work is complete. When the shoulder is used to carry traffic, the roadside obstacles on that side will be closer. The existence, proximity, and nature of roadside features should be considered in assessing this strategy. The shoulder is not intended for truck use. Vertical panels shall be placed along the shoulder, in instances where there are no alternate vehicular paths. Spacing shall be at 100' on tangent roadways and 50' on tapers and on curves. Vertical panels may be omitted where guardrail or barrier wall is present. Reference Article 6.4.5.

Openings exist within the median concrete barrier for emergency turnarounds. The ends of the concrete barrier in each direction are shielded by energy attenuators. The opening length between median barrier wall varies. Where traffic is to be routed onto the median shoulders this opening should be closed to shield vehicles from crossing into lanes in the opposing direction of travel. However, since the Illinois Tollway Maintenance and Local Emergency Responders use these turnarounds, the Illinois Tollway will review the work zone location and determine which are to be temporarily closed. Where a temporary barrier is not placed to close these openings, flexible post delineators shall be installed. These devices present a visual barrier within the opening yet provide access for emergency vehicles.

5.3.13 Reduced Lane Width

For mainline single lane operations without trucks, the minimum traveled way width shall meet the Case II, Condition A requirements in AASHTO Green Book Table 3-27. If trucks are allowed, then Case II, Condition C shall be met. If the single lane operation does not exceed 1500 feet in distance, then the minimum traveled way width may meet Case I Condition C. This condition shall only be applicable if there are restrictions in meeting the Case II criteria. Provide a 2-foot desirable or 1-foot minimum shy distance to any traffic control device. The traveled way width is inclusive of the shy distance.

For mainline multiple lane operations, the minimum lane widths shall be 11 feet measured between pavement lane markings (11'- 4" measured between the centers of pavement lane marking stripes). Provide a 2-foot desirable or 1-foot minimum shy distance to any traffic control device.

Consideration of roadway geometry and type of work to be performed is necessary in establishing this lane width. A wider lane width is required for the tracking of larger vehicles when on sharp horizontal curves. Evaluate the need for an alternative wide-load detour route. Ensure the wide-load detour is adequately marked in advance of the construction work zone.

For minimum traveled way width requirements on ramps, refer to Section 5.3.20.

5.3.14 MOT Modifications

When the Contractor proposes changes to the design MOT plans, an evaluation for potential roadside obstacles shall be performed as well as identifying impacts to the project's work zone issues along with schedule and costs.

When an alternate traffic pattern is proposed within the contract, the Contractor shall submit a MOT deviation plan, 21 days prior to the changes for acceptance by the Illinois Tollway. In addition, the Contractor is required to attend a MOT meeting arranged by the Illinois Tollway CM with representatives of the Illinois Tollway to review the proposed changes in the MOT 2 days prior to the implementation of the new MOT stage changes.

5.3.15 Temporary Stoppage of Traffic

Temporary stoppage of traffic is a construction work zone mitigation strategy wherein traffic in one or both directions is stopped for a relatively short period to allow restricted construction operations. It is employed during specific operations (e.g. setting bridge beams) for which project personnel can select a beginning point and reasonably predict the duration. This strategy temporarily removes the traffic from all or part of the work area for a short period of time, usually during the non-peak traffic times. Prior approval from the Illinois Tollway and coordination with the ISP is required. The maximum duration permitted for this strategy shall be in accordance with Article 701.06(h) of the Supplemental Specifications, and generally will not exceed 15 minutes. Consideration for extended closures should be provided when complex operations are required.

5.3.16 Night Work

High traffic volumes on the Illinois Tollway make it difficult to perform various work zone operations in or near travel lanes during much of the day because of the disruption in traffic flow and the risk this introduces for the workers and the traveling public. As a result of these concerns, all types of

highway work are increasingly scheduled for off-peak periods, particularly at night, to alleviate the problems associated with working in or near travel lanes.

On many sections of the Illinois Tollway, night work is the only time where lane closures are allowed. Night construction allows for conducting construction operations during reduced traffic demand. Night traffic volumes are generally significantly lower than daytime volumes. The advantages of night work are associated with lower traffic volumes and lower traffic impacts. The disadvantages are higher agency costs, decreased visibility and noise restrictions.

5.3.17 Mainline Open Road Tolling Work

The following guidelines and procedures are to be followed for mainline Open Road Tolling (ORT) work.

- No full or partial lane shifts are permitted. Traffic must be kept in established lanes due to lane loops in the roadway pavement used for electronic tolling.
- Positive protection (e.g., temp concrete barriers) and equipment placement requires coordination with Business Systems to avoid conflicts with lane loops in the pavement used for electronic tolling.
- When shoulder use is necessary, coordination with Business Systems is required.
- ORT lane closure is to be coordinated with Toll Services and Plaza Supervisors for assessing staffing requirements.
- Counter-flow lanes through the ORT zone are permitted. Coordination with Business Systems is required.
- Lane Closure Reference Guide is to be followed. 21-Day Notification must include Toll Services and Business Systems when I-PASS Only (IPO) lane is affected.
- Temporary full ORT closure is permitted for restricted night work. Coordination with Business Systems is required.
Reference Documents: Section 15 of this MOT MANUAL.
PLATE 13-PLAZA MAINTENANCE FULL ORT CLOSURE-TWO LANES
PLATE 14-PLAZA MAINTENANCE FULL ORT CLOSURE-THREE LANES
PLATE 15-PLAZA MAINTENANCE FULL ORT CLOSURE-FOUR LANES

5.3.18 Mainline Plaza Work (Non-Open Road Tolling)

Each toll plaza presents unique features; traffic volume, ramp entrance-exits, etc., which must be assessed. The following guidelines and procedures are to be followed for mainline plaza work.

- Temporary closure to the IPO lane is permitted.
- Business Systems coordination is required with IPO lane closures.
- Plaza Supervisor coordination is required for assessing staffing requirements.
- Lane closure request form must be completed; provided from the Illinois Tollway PM.

- The far lane on the right side of mainline plazas accommodates 12 feet wide, permit vehicles. Closure of this lane requires special coordination for permit pick-up, vehicle routing, etc.
- Lane conversion tasks:
 - Contractor work: Installation of conduits, loops, pavement, etc.
 - Force Account Work: Installation of electronic tolling system connections.
 - Access to ORT cabinets must be maintained.

5.3.19 Ramp Plaza Work

The following guidelines and procedures are to be followed for ramp plaza work.

- At a minimum, the existing traveled way width at Toll Plazas shall be maintained.
- If lane closures are required, the following coordination is required:
 - Coordination with Illinois Tollway Maintenance & Traffic is required to determine allowable closure hours.
 - Coordination with Business Systems is required, which shall include verification of equipment availability.
 - Coordination with Illinois Tollway Tolling Operations is required to assess staffing requirements.
 - When any lane at a ramp plaza is to be closed, special coordination is required for permit vehicles. Permit pick-up, vehicle routing, etc., is required.
- If a deactivated/inactive IPO lane needs to be reactivated, Illinois Tollway Maintenance & Traffic and Illinois Tollway Business Systems will determine if an deactivated/inactive lane can be reactivated, or if another approach can be used based on details of the specific plaza.
- Work on single lane ramps is a special condition; requiring the ramp to be closed overnight or for a specific period of time with a detour route.

5.3.20 Interchange Ramp Work

Maintaining existing access points is desirable for established traffic patterns. When a complete interchange ramp closure is necessary, prior authorization from the Illinois Tollway will be required. A detour route must be established with coordination and approval from agencies impacted by the rerouting of traffic onto other roadways.

Consideration of ramp geometry and traffic conditions is necessary in establishing the minimum lane width. A wider lane width is required for the tracking of larger vehicles when on sharp horizontal curves. The minimum ramp traveled way width shall meet the Case I, Condition C requirements in AASHTO Green Book Table 3-27. The traveled way width used shall also meet the truck swept path requirements for design vehicle WB-67. The traveled way width is inclusive of the shy distance.

For rehabilitation projects, existing acceleration, deceleration, and taper lengths should be preserved to the extent possible. Where existing lengths cannot be maintained, consideration will be given for specifying limited duration substages or off-peak closures when necessary for work to be performed at the ramps.

Stages that reduce the traffic capacity or storage of ramps, which could impact mainline traffic shall be coordinated with Illinois Tollway Maintenance and Traffic and evaluated to determine if limited durations should be specified for those stages. This evaluation should also consider traffic

impacts caused by concurrent mainline work or work on off-system roadways which could potentially back up onto Illinois Tollway ramps.

Mainline barricade spacing before exit ramps shall be 25 foot on center starting at the exit taper or start of the taper for development of the deceleration lane prior to construction.

Where edge delineation is provided by barrels or barricades, the type of device used for the exit and entrance tapers at ramps shall be of a different type than is used for mainline. For example, if barrels are used along the edge of the outside lane, type 2 barricades or vertical barricades shall be used for the ramp tapers.

The MUTCD provides considerable guidance and illustrated examples of MOT provisions and schematic geometry for accommodating interchange ramps within work zones.

5.3.21 Use of Positive Protection Devices

Reference: Section 7 of this MOT MANUAL.

5.3.22 Longitudinal Drop-Off Policy

Reference: Section 8 of this MOT MANUAL.

5.3.23 Detour Routes

The Designer shall present to the Illinois Tollway Detour Committee any project that has contemplated a detour route as part of its MOT. The Designer shall state reasons why a detour will be required. A detour should be a last resort after exhausting all other options. No coordination with outside agencies should be conducted until directed by this Committee.

5.3.24 Rollover and Lane Straddling

Temporary lane configurations may occasionally require traffic lanes to traverse pavement and shoulders where a rollover exists. The lane configurations shall not result in vehicles straddling or crossing a rollover (the algebraic difference in cross-slope) that exceeds 5%.

5.3.25 Use of Road Steel Plates

Road Steel Plates, of any kind, shall not be used to support traffic on the Illinois Tollway, during construction, in order to open lanes prior to completion.

5.3.26 MOT During Winter Season

Illinois Tollway snow removal operations shall be considered, during design, for winter season beginning December 1 and ending March 31. Consideration should be given to provide a full outside shoulder width of 11 feet. If conditions preclude the use of the full outside shoulder width, then a minimum of 8-foot width should be provided. Counterflow lanes or shifts of traffic onto opposing highway pavement is not allowed and shall be removed. Express and local lane splits should be minimized, and only provided where existing offset bridge piers or other obstacles cannot be designed around. Each direction of traffic shall maintain the existing number of mainline lanes, as they were prior to construction.

5.4 Application of Principles

5.4.1 Uniformity

The principle of uniformity calls for always handling a given situation in a similar manner using standard devices and procedures that are familiar to motorists. Uniformity reinforces expectations of drivers and increases the likelihood that they will take proper and timely actions as they negotiate the work zone.

The primary action to achieve uniformity is to follow this MOT MANUAL whenever possible. When special procedures must be employed to handle unusual conditions, the goal is to provide information and guidance in a way that is familiar to drivers.

Reference: Appendix C - Procedures for Placing Traffic Control Signage, and Appendix D - the Work Zone Safety Inspection Checklist.

5.4.2 Adaptation

The traffic control procedure employed must be adapted to field conditions as they exist in the vicinity of the work zone. The MOT plans, MOT Plates, and the Illinois Tollway MOT Standard Drawings form the starting point in this adaptation process. The devices selected must be appropriate to the situation, considering the degree of obstacle involved and the potential for corrective action by the motorist before encountering such obstacles.

5.4.3 Compensation

Compensation can occur when it is not possible to install the plan or device in the location or manner called for in the MOT plans, the Illinois Tollway MOT Standard Drawings, or typical MOT Plates. Such constraints can be caused by limitations on space, sight distance, mobile operations, etc. The principle to employ is to compensate for a substandard feature by providing more than the minimum called for in another area or feature. Through this process, such limitations can be overcome, and an equivalent level of safety can be achieved.

Typical methods of compensating are to employ more devices, or ones that are larger or more visible.

5.4.4 Redundancy

Redundancy is a means of providing the motorist with additional opportunities to obtain requisite information, take proper action, and make corrective adjustments, if required. Warning signs are designed to deliver logical and increasingly explicit information on the situation ahead and actions that are required. The sign series provides essential information, even though some signs may not be observed.

For a typical lane closure, the advance warning signs are only the first information offered. The second form of the message is usually provided by channelizing devices placed on a taper. For long-term projects, pavement markings may also show required movements and will continue to function even if the channelization is displaced; if a motorist is inattentive, they may even penetrate the taper area before they recognizes the situation. The long tapers prescribed provide space and opportunity for a driver to regain control of their vehicle within the transition area. An

empty buffer space provided at the upstream end of the work area provides additional recovery space.

5.5 Duration

Selection of the proper traffic control procedure is in part determined by the duration of the activity that is to be performed. To illustrate this principle five categories are defined below. Under each category, the critical features affecting changes in traffic control procedures are described.

5.5.1 Short Duration

Short-duration activities are defined as those for which the erection of a standard work zone and the removal of that zone represent a greater effort and/or involve a greater obstacle than the performance of the work itself. Typically, the range of time required to perform such short-duration work is less than one hour.

In recognition of the hazards involved in installing and removing devices and the limited amount of exposure involved, some reduction in the number of devices used may be warranted. When this approach is used, the principle of compensation is applicable.

A maintenance truck may be placed in the lane upstream from the crew with an arrow board to warn the motorist. A highly visible combination of vehicle and flashing or rotating lights may compensate for the absence of some of the full set of standard warning signs and channelizing devices.

In such instances, proper timing of the activity is important. If the extent of the work zone is to be reduced, the work should be performed when hazards are minimized, such as midday when lower traffic volumes may prevail, and under good sight distance and weather conditions.

Any questions concerning the reduction in the number of devices shown in the Plates covering typical application should be discussed with the proper Illinois Tollway personnel prior to undertaking the work.

5.5.2 Short Term Stationary

Short-term stationary work is daytime work that occupies a location for more than 1 hour within a single daylight period.

5.5.3 Intermediate Term Stationary

Intermediate-term stationary work is work that occupies a location more than 1 daylight period up to 3 days, or nighttime work lasting more than 1 hour. Once night-time closures are involved, additional procedures must be employed to warn motorists of the greater potential hazards due to restricted visibility and to enhance the target value of certain devices.

However, because intermediate-term work lasts only a few days, it may not be practical to undertake the placement of features which may be required for major longer-term projects. For example, the removal of temporarily inapplicable pavement marking and the subsequent reinstallation of same may require more time and/or effort than is warranted. Likewise, the

construction of crossover points or the erection of temporary barriers may not be practical for intermediate-term activities.

When such costly features as temporary roadways and barriers are not specified due to the relatively short project duration, other devices and features shall be employed which provide a high level of safety for motorists and workers.

5.5.4 Long Term Stationary

Long term stationary work is work that occupies a location more than 3 days. For these projects, the exposure is high in terms of the total number of vehicles passing through the work zone and the number of crew days of work. More elaborate and extensive forms of traffic control may be warranted. Signs are typically mounted using the same standards as employed for permanent mountings.

The traffic control procedures defined in this MOT MANUAL may warrant expansion and upgrading for long-term activities. For example, where severe obstacle conditions exist, barriers and appurtenant features should be considered instead of channelizing devices for minimizing occurrences of errant vehicles entering construction areas.

5.5.5 Mobile Operations

Mobile operations pose special problems as compared with standard stationary activities. As devices must be relocated periodically or continuously, the approach generally selected is to employ fewer but larger and more-visible traffic control devices.

1. Intermittent Stop – Intermittent stop operations are those which are constantly being relocated along the highway. If several minutes are required at a work area, then the treatment to be employed is essentially the same as that used for short-duration activities. If frequent stops are to be made for a few minutes or less, then the traffic control procedure to use is that described below for fast moving operations. An example of an intermittent stop activity is debris pickup.
2. Slow Moving – Slow moving operations are defined as those that proceed down the roadway at less than five MPH. For such operations, stationary advanced warning signs and channelizing tapers are used. A standard work zone is established as defined in the applicable Plate with the work area having sufficient length to accommodate the moving activity within it. There are procedures which may be used to avoid having long lane closures for the entire work period. For example, once the stationary advance warning area and transition area are established, the work area may be lengthened as the work proceeds in the direction of traffic. This procedure provides an expanding work zone. An alternative is to set out a closure that contains the entire length of contemplated work and to work upstream towards the stationary transition area. A diminishing work zone is created when this procedure is used. Another method is to employ two sets of traffic control devices and use a leapfrog procedure. These techniques all make use of stationary devices, which are periodically moved as work progresses. An example of a slow-moving activity is crack sealing.
3. Fast Moving – Fast moving operations are those that move at speeds between five and thirty MPH. At these speeds, traffic control devices that are ordinarily placed upstream of

the work area must be moved continuously as the work progresses. The speed of travel is too great to place them and, periodically retrieve them; also, the spacing criteria between the signs and the actual work area must be maintained. Plates 9 and 10 cover fast-moving operations for a single lane closure and for a two-lane closure. In both instances, moving vehicles are used as arrow board supports and to create a channelizing taper. An example of a fast-moving operation is pavement marking. If a moving operation is performed at speeds greater than thirty MPH, the hazard is reduced as the work vehicle is moving essentially with traffic. In such instances, the traffic control requirements may be reduced as compared with those shown in the plate. Frequently, the vehicles are equipped with appropriate devices such as rotating/flashing beacons, signs or special lighting.

SECTION 6.0 DEVICE REQUIREMENTS

6.1 Safety Hardware Testing

The *AASHTO Manual for Assessing Safety Hardware 2016* (MASH) is the new state of practice for the crash testing of safety hardware devices. It updates and replaces the National Cooperative Highway Research Program (NCHRP) Report 350 testing standards. A MASH hardware implementation agreement between AASHTO and the FHWA was issued in a joint memorandum, dated January 7, 2016. This *AASHTO/FHWA Joint Implementation Agreement for Assessing Safety Hardware (MASH)* memorandum outlined the requirements for incorporating MASH devices into new permanent installations and full replacements of roadside safety devices.

The *Implementation Agreement* includes the following about work zone devices:

“Temporary work zone devices, including portable barriers, manufactured after December 31, 2019, must have been successfully tested to the 2016 edition of MASH. Such devices manufactured on or before this date, and successfully tested to NCHRP Report 350 or the 2009 edition of MASH, may continue to be used throughout their normal service lives.”

MASH does not supersede any guidelines for the design of roadside safety hardware, which are contained within the AASHTO RDG. An implementation plan for MASH that was adopted jointly by AASHTO and FHWA states that all highway safety hardware accepted prior to the adoption of MASH – using criteria contained in NCHRP Report 350 – may remain in place. In addition, highway safety hardware accepted using NCHRP Report 350 criteria is not required to be retested using MASH criteria. However, new highway safety hardware not previously evaluated must utilize MASH for testing and evaluation.

For devices that must meet crashworthiness standards, the Contractor shall provide a manufacturer’s self-certification or a FHWA eligibility letter for each Category 1 device and a FHWA eligibility letter for each Category 2 and Category 3 device used on the contract. The self-certification or letter shall provide information for the set-up and use of the device as well as a detailed drawing of the device.

Category 1 includes small, lightweight, channelizing and delineating devices that have been in common use for many years and are known to be crashworthy by crash testing of similar devices or years of demonstrable safe performance. These include cones, tubular markers, plastic drums, and delineators, with no attachments (e.g., lights). Category 1 devices manufactured after December 31, 2019, shall be MASH compliant. Category 1 devices manufactured on or before December 31, 2019, and compliant with NCHRP 350 or MASH, may be used on contracts let before December 31, 2024.

Category 2 includes devices that are not expected to produce significant vehicular velocity change but may otherwise be hazardous. These include vertical panels with lights, barricades, temporary sign supports, and Category 1 devices with attachments (e.g., drums with lights). Category 2 devices manufactured after December 31, 2019, shall be MASH compliant. Category 2 devices manufactured on or before December 31, 2019, and compliant with NCHRP 350 or MASH, may be used on contracts let before December 31, 2024.

Category 3 includes devices that are expected to cause significant velocity changes or other potentially harmful reactions to impacting vehicles. These include crash cushions (impact

attenuators), truck mounted attenuators (TMA), and other devices not meeting the definitions of Category 1 or 2. Category 3 devices manufactured after December 31, 2019, shall be MASH compliant. Category 3 devices manufactured on or before December 31, 2019, and compliant with NCHRP 350 or MASH, may be used on contracts let before December 31, 2024. Category 3 devices shall be crash tested for Test Level 3 or the test level specified.

Category 4 includes portable or trailer-mounted devices such as arrow boards, changeable message signs, temporary traffic signals, and area lighting supports. It is preferable for Category 4 devices manufactured after December 31, 2019, to be MASH compliant; however, there are currently no crash tested devices in this category, so it remains exempt from the NCHRP 350 or MASH compliance requirement.

For each type of device, when no more than one MASH compliant device is available, an NCHRP-350 or MASH compliant device may be used, even if manufactured after December 31, 2019.

6.2 General Requirements

In this section of the MOT MANUAL, the requirements for each of the various types of traffic control devices used at work zones are discussed in detail. Specifications are presented regarding the selection, size, application and placement of devices used on the Illinois Tollway. Where different practices are encountered for maintenance operations and construction activities, the needs of each are stated.

To reduce the inventory of devices used for maintenance operations, devices are specified which can be utilized for a wide range of traffic control situations. In some instances, special signs are defined which can readily be derived from standard signs by the addition of a supplemental plate to the sign face.

The intent of the specifications presented in this document is to limit the range of devices permitted by the MUTCD. Device types are selected which are most appropriate for the high-speed, high-volume, fully-controlled access characteristics of the Illinois Tollway. In general, the largest standard-sized device is specified. For more detailed specifications, reference should be made to the MUTCD. It must be recognized, however, that the MUTCD is continually being updated and modified. Where changes are made that cause this MOT MANUAL to be out of conformance with the MUTCD, the provisions of the MUTCD prevail.

For construction projects reference should be made to the Standard Drawings pertaining to the MOT furnished as part of the Contract Documents. This document serves as a guideline for the design of traffic control procedures for construction activities. However, the work zone specifications may require adaptation of this MOT MANUAL to adjust to specific conditions encountered during project phases.

Approval of the Illinois Tollway's Chief Engineering Officer is required before any traffic control device not included in this MOT MANUAL is placed on any portion of the Illinois Tollway system.

6.3 Signs

All existing signs along the Illinois Tollway within the work zone are to be maintained. These shall include but not be limited to tolling signage, informational signs, guide signs, mile post signs, and airport and oases signage.

All standard signs shall conform to the requirements of the contract documents, the MUTCD and its supporting manuals, and the MOT MANUAL. In complying with these requirements, the Contractor and suppliers will furnish signs that are correct in size, shape, color, and legend. Special signs, should they be required, are to be detailed in the plans. Article. 1091, Table 1091-2, Type A of the Standard Specifications provides the requirements for retroreflection.

For signs to be used in work zones, all of the preceding requirements shall be met to the satisfaction of the Illinois Tollway. In addition, Section 701 of the Illinois Tollway Supplemental Specifications regarding sign erection and sign installation dimensions shall be met. Sign positioning at the work zone may be minimally adjusted with CM approval based on site conditions.

6.3.1 Sign Usage

Signs are utilized at work zones to inform drivers as to changes in regulations, to provide advanced warning of potentially hazardous conditions and to present information to guide motorists on the proper use of the roadway. Various types of signs including regulatory, warning and guide signs may be used in a work zone. The majority of the signs specified in the MOT Plates and Standard Drawings, however, fall into the category of warning signs. On contracts with lane shifts or long-term closures, overhead signs shall be evaluated to determine what modifications are required based on the revised lane usage in each stage.

6.3.2 Sign Design

The design features of signs include such items as shape, color, corner radius, border width, letter size, legend placement, and symbol dimensions. All such features shall conform first to the provisions of the Illinois Tollway Roadway Signing and Pavement Marking Guidelines, and Standard Drawings, and then, if applicable, the IDOT Highway Standards. In the absence of these, all such features shall conform to the MUTCD. For information not provided in the MUTCD, refer to the publications entitled "Standard Highway Signs" and "Standard Alphabets for Highway Signs" published by the FHWA.

All construction signs and all other signs which may be used shall have a reflectorized background.

6.3.3 Sign Sizes

Wherever the MUTCD defines more than one size, the largest size shown shall be used. The standard size for diamond-shaped warning signs shall be 48-inch X 48 inch. The standard size for regulatory signs, such as KEEP RIGHT (LEFT) and DO NOT PASS shall be 48-inch x 60 inch. Advisory speed plates shall be 24-inch x 24 inch, unless otherwise indicated. "Advisory" speed plates should only be used on ramps. Elsewhere, regulatory speed limit signs should be used as necessary.

For use on other than mainline roadways, smaller signs may be used in those instances where space limitations preclude the use of the largest sizes.

6.3.4 Sign Placement

1. Longitudinal Position - Warning signs are typically placed in advance of the situation to which they apply to provide adequate time for drivers to recognize the situation and take appropriate action. There are two exceptions to this rule: the Large Arrow sign is placed at the point where the change in direction is required and the TWO-WAY TRAFFIC sign is placed within the applicable area.

Regulatory signs are generally placed at the point where the regulation takes effect. Guide signs may be placed in advance or at the applicable point, or both. Regulatory and Warning signs should be repeated within the work zone, as necessary, to remind the motorist that the regulations are still in effect or to confirm warning information.

Longitudinal sign positions and spacing for typical applications are given in the Standard Drawings. For mainline roadways, the first warning signs are generally placed 3 to 5 miles in advance of the transition or point of restriction. The minimum sign spacing on the mainline is 500 feet. When shifts and splits follow in close proximity, this spacing may be difficult to implement. In such locations, an occasional 250 to 300 feet spacing may be required.

Where lower speeds are encountered, such as on ramps, within plazas and oases, these spacings may be reduced; but in no instance should sign spacing be less than 200 feet.

In selecting a sign location, consideration must be given to visibility constraints due to the horizontal and vertical alignment of the roadway and the presence of obstacles to vision, such as light poles and bridge piers. Adjustments should be made, as needed, to provide good visibility toward the upstream travel lanes. Likewise, attention must be given to the location of other permanent signs. Work zone signs should be positioned at least 200 feet away from other existing signs, if possible. When such adjustments are substantial, the preferred approach is to increase distances beyond those shown.

2. Lateral Position - The standard location for signs is on the right side of the traveled way. Where there are two or more travel lanes in the same direction, as is normally the case on the Illinois Tollway, the sign message should be repeated on the left side of the roadway. In segments with 3 or more lanes in one direction, smaller signs mounted on the median barrier or on the opposite median shoulder should be utilized.

All signs shall be erected approximately at right angles to and facing the traffic they are to serve and placed in positions where they will effectively convey their messages. Signs shall be located with a minimum clearance of 2 feet between the sign and the edge of the adjacent lane. Exception to this is the emergency pull-out signage which is to be attached to the temporary concrete barrier.

For short and intermediate-term activities, signs may be mounted on temporary supports placed on shoulders. They should be placed away from the adjacent lane, however, to enable the shoulder to be used for emergency purposes to the fullest extent possible.

For long-term projects shoulders should be kept open, if possible, and temporary signs should be post-mounted using the same placement criteria as for permanent signs. A spacing of 8 to 12 feet from the traveled way is desirable.

3. Vertical Position - Post-mounted signs shall be placed with the bottom a minimum of 7 feet above the roadway. If a secondary sign is mounted below another sign on the Illinois Tollway, the major sign shall be installed with a minimum height of 8 feet and the secondary sign shall be installed with a minimum height of 5 feet, measured vertically from the bottom of the sign to the elevation of the near edge of the pavement.
4. Signs installed temporarily on overhead structures may need to be larger than the standard sizes in order to have sufficient target value. In instances where warning signs are added to overhead guide sign assemblies, specifically designed signs may be desirable to provide both warning and guidance messages within the space available.

6.3.5 Sign Mountings

Portable sign supports shall be designed or constructed to yield upon impact to minimize hazards to motorists, yet they shall be sturdy enough to stand under anticipated roadway conditions. Ballast shall be used as needed to provide stability.

Signs may be mounted on portable supports, posts, on the back of vehicles for mobile operations and upon existing overhead sign bridges and structures.

Post-mounted signs shall be mounted on wood posts no larger than 6-inch x 6 inch or on steel or aluminum supports of a size that do not constitute an obstacle to motorists.

All sign supports shall meet the requirements of the NCHRP Report 350-Test Level 3 or MASH-Test Level 3.

6.3.6 Special Signs

Special signs are used in those instances where a standard sign is not available which can adequately meet the needs of the particular situation. Other special signs may be needed for unique traffic control situations which must be handled. The principle to be employed in the design of a special sign is that it should conform to the Illinois Tollway's general specifications for shape, color, and placement. Note that such signs are referred to as "special standard signs" as opposed to non-standard signs.

Special signs other than those defined in this manual shall be approved by the Illinois Tollway's Chief Engineering Officer prior to their fabrication.

6.4 Channelizing Devices

6.4.1 General Characteristics

1. Functions - Channelizing devices are placed in the roadway and adjacent to travel lanes to control the flow of traffic. They have the following three functions:
 - a. To warn and alert drivers of obstacles in or adjacent to the roadway

- b. Placed along a taper, to force the movement of traffic from one lane or path to another
- c. To delineate the desired travel path and guide drivers through the work area.

Channelizing devices and associated warning signs shall not be stored on the roadway or within the clear zone. Such devices must be removed from the road or may be stored behind guardrail in accordance with Article 11.4.1, Work and Storage Locations, well outside the clear zone, or within permanent shoulder closures associated with the project.

It must be recognized that channelizing devices may constitute obstacles themselves; therefore, motorists shall be warned with appropriate signs about the work zone before they proceed into a roadway area in which channelizing devices have been placed.

Channelizing must be positioned so that all activity takes place within the work area behind the channelizing devices and causes no interference to traffic. If workers or equipment are required to work outside the work area, the channelization is inadequate and an additional lane may need to be taken out of service.

2. Types of Channelizing Devices - Channelizing devices fall into two categories. Devices in the first category provide visual guidance and alert drivers to construction areas. These devices are cones, drums, tubular markers, barricades, vertical panels and pavement markings. They should be fabricated to offer minimum physical impact and to eliminate or minimize vehicle occupant space penetration when hit. Barriers form the second category. Barriers are designed to provide positive protection to the work zone from vehicular penetration, as well as visually as reflectors are attached to the face of the barrier to alert the drivers to the presence of the barrier adjacent to the traffic lane. Warning lights may be added to channelizing devices in areas with frequent fog, snow, severe roadway curvature, or where visual distractions are present. Warning lights are required for all channelizing devices used overnight.
3. Channelizing Device Spacing - Channelizing devices should be placed sufficiently close together to appear as a continuous line of devices at normal travel speeds. On tapers, the line of devices lies across a travel lane and the motorist tends to look through them. Therefore, close spacing is used on tapers. Beyond the transition area a longer spacing may be used along the work area, as motorists are traveling parallel to the line of devices. The basic device spacing specifications are given in the MOT Plates and Standard Drawings. For channelizing tapers a 50-foot maximum spacing shall be used. After a channelizing taper, the devices along the buffer space shall be placed at a 50-foot maximum spacing. Additional devices in the work area shall be placed at a maximum spacing of 100 feet. The channelization shall be continued for at least 100 feet beyond the work area. Along curves the device spacing may be reduced to provide the appearance of a continuous line. When the roadway curvature is less than a 1430-foot radius, the maximum device spacing shall be 50 feet within both the transition area and the work area. When curvature is less than a 715-foot radius, such as may occur on ramps, the maximum device spacing shall be 25 feet. When traffic is shifted onto the shoulder, barricades or other channelizing devices shall be placed along the outer edge of shoulder at twice the spacing distance used on the work area side, unless adjacent to guardrail or other barriers.

4. Use of Tapers - Standard taper lengths are given in the MOT Plates and Standard Drawings. These should be considered as minimum taper lengths unless physical constraints, such as ramp terminals, require shorter lengths to meet field conditions. Channelizing tapers shall be placed in full view of the upstream roadway. Where horizontal alignment or crest vertical curvature creates reduced sight distances, the buffer space should be carried further upstream and the channelizing taper placed where good approach visibility exists. The standard length for a lane-closing channelizing taper is 800 feet. When two lanes are closed, a transition distance 2000 feet long is placed between the two individual 800-foot tapers. A taper used to close a shoulder shall be a minimum length of 200 feet. Shorter tapers may be used in toll plazas and on non-mainline roadways where lower speeds occur. The applicable formula for channelizing tapers is $L=WS^2/60$; where L is the taper length in feet, W is the lateral shift or lane width, and S is the speed in MPH. The speed value to be used in this formula should be the greater of either the posted speed limit or the 85th percentile actual speed. If there are any questions concerning the application of this formula, the matter should be first resolved with Engineering Department personnel. When a downstream taper is used, a short 100-foot taper consisting of four additional devices at a 25-foot spacing is appropriate.

6.4.2 Cones

1. Specifications - Cones used to channelize traffic on the Illinois Tollway shall have a nominal height of 28 inches and shall have a broadened weighted base to provide stability in accordance with IDOT Standard 701901 (See Appendix E). The predominant color shall be fluorescent orange. When used for emergency nighttime applications, the cone height should be a nominal height of 36 inches, and two white retroreflective bands shall encircle the cone. Cones shall be made of material able to withstand impact without damage to the cone or the vehicle.
2. Application - Cones are intended for use on short-duration and short-term daytime maintenance and utility operations. When a closure is expected to extend into the hours of darkness (one hour before sunset), Type II or vertical barricades, with steady-burning Type C barricade lights if required, shall be used instead of cones.

6.4.3 Drums

Specifications - Drums used for channelizing shall be of a size commonly referred to as 55-gallon capacity with a height of approximately 36 inches and a minimum diameter of 18 inches in accordance with IDOT Standard 701901 (See Appendix E). Drums shall be nonmetallic and have alternating Type AA or Type AP fluorescent orange and reflectorized white, horizontal, circumferential stripes. The markings on drums shall be horizontal, circumferential, alternating orange and white reflectorized stripes four to eight inches wide, using a material that has a smooth, sealed outer surface which will display the same approximate size, shape and color day and night. There shall be a minimum of three orange and two white stripes on each drum. If there are any spaces between the horizontal orange and white stripes, they shall be no more than two inches wide. Drums shall be weighted in a manner approved by the manufacturer so they are not moved by wind or traffic.

6.4.4 Barricades

Several types of barricades are specified for use on the Illinois Tollway for maintenance and construction operations.

1. Type I and Type II Barricades - Type I and Type II barricades are lightweight portable barricades 24 inches wide and 36 inches high excluding any warning lights in accordance to IDOT Standard 701901 (See Appendix E). Type I barricades shall have a single rail 8-12 inches high with reflectorized striping. Type II barricades are Type I with the addition of a lower reflective-stripped rail.

Type I barricades are used exclusively as patching barricades and are to be placed in front of any intermittent pavement openings inside a channelized work area.

Type II barricades are used for the following applications:

- a. Along the buffer space and work area portions of the work zone, as well as along the limits of a lane shift for construction projects, and for maintenance activities that extend into the hours of darkness.
 - b. For the tapers and along the buffer space and work area portions of shoulder closure work zones.
2. Type III Barricades - Type III barricades are a minimum of 48 inches wide and 60 inches high (excluding warning lights) and have three reflective-stripped rails in accordance to IDOT Standard 701901 (See Appendix E). Three additional rails shall be added facing the opposite direction, if they can be seen by normal traffic movement from that direction.

Type III barricades shall be used where it is necessary to close a roadway. They are typically erected across the closed roadway at the point of closure. Flashing yellow lights may be placed upon the barricade, as needed. Signs may also be attached to the barricade when they are used on crossroads with the approval of the respective governing agency. When used to close a ramp, the Type III barricade(s) are placed across from the gore point, and behind a line of Type II barricades placed along the deceleration lane.

At locations where additional work zone delineation is required, Type III barricades should be used as check barricades for the first set, and each subsequent 3rd set. Type III barricades shall be added at other locations where frequent intrusion of unauthorized vehicles into the work zone is observed.

For projects where dump trucks will be utilized for material hauling, Type III barricades should be used in conjunction with signage within the work zone to alert truck drivers of overhead hazards such as sign structures, bridges and aerial utilities.

3. Vertical Barricades – Vertical barricades are frame and rail supported, similar to Type I and II barricades. The vertical panel shall be 12 inches wide, with a minimum overall height of 36 inches, excluding the warning light in accordance with IDOT Standard 701901 (See Appendix E).

Vertical barricades may be used in lieu of Type II barricades.

4. Direction Indicator Barricades – Direction indicator barricades are Type II barricades, except the top rail shall be sheeted totally in reflective orange, with a black indicator arrow in accordance with IDOT Standard 701901 (See Appendix E).

Direction indicator barricades shall be used exclusively in the merging taper portion of the lane closure, with the arrow pointing toward the open lane(s). Direction indicator barricades shall not be used in lane shifts, as it could give the impression of a lane reduction.

5. Barricade Specifications - Barricades are composed of horizontal panels 8-12 inches wide containing alternating orange and white stripes sloping downward at an angle of 45 degrees toward the side to which traffic is to pass.

The entire area of orange and white shall be reflectorized with a material that has a smooth, sealed outer surface which will display the same approximate size, shape and color day and night. The predominant color for other barricade components shall be white. Barricades should be made of lightweight components to minimize the hazard to motorists, if hit; but must be made sturdy enough to stand under anticipated roadway conditions. All barricade framing shall meet the requirements of the NCHRP Report 350 or MASH.

Barricade warning lights attached to Type II, Type III, Vertical or Direction Indicator barricades, when required, shall be placed above the top rail with the bottom of the lens 38 to 62 inches above the ground. The light shall be mounted close to the outboard end of the reflectorized rail on the side facing traffic. No portion of the light housing should obstruct the reflectorized rail in the predominant traffic direction.

6.4.5 Vertical Panels

1. Specifications - Vertical panels used as channelizing devices shall be 8 to 12 inches wide and, at least 24 inches high, with the top positioned a minimum of 48 inches above the elevation of the roadway in accordance with IDOT Standard 701901 (See Appendix E). The entire face shall be colored and reflectorized following the same pattern and specifications given for barricade rails.
2. Applications - The predominant use of vertical panels is to provide channelization and delineation where restricted lateral clearance precludes the use of barricades or drums. They may be used to delineate the edge of temporary roadways, such as crossovers and runarounds.

6.4.6 Tubular Markers

1. Specifications - Tubular markers shall be predominantly orange, not less than 36 inches high and at least 2 inches wide facing traffic. They shall be made of a material that can be struck without damaging vehicles. For nighttime use, tubular markers shall be reflectorized.
2. Application - Tubular markers have less visible area than other devices and should be used only where space restrictions do not allow for the use of other devices. Tubular markers shall not be used to separate opposite directions of traffic on Illinois Tollway facilities.

6.4.7 Barriers

1. Applications - Barriers are devices designed to minimize penetration by a motor vehicle while redirecting an impacting vehicle in such a manner as to minimize damage to the vehicle and its occupants.
2. Barrier Specifications - The standard type of temporary barrier to be used on the Illinois Tollway is the Temporary Concrete Barrier with Cross-Bolt Connection.

Barrier sections shall be precast concrete in 12.5 feet sections. The ends of each section shall have a cross-bolt which causes the barrier sections to act as a continuous stiffened barrier line when impacted. An additional provision may be made for fastening the units to an underlying pavement or bridge deck when allowable deflection is to be limited. Sections shall be designed to provide lifting points and sufficient reinforcing to withstand lifting stresses. Recesses shall be provided on the bottom sides which are of sufficient size to permit water to flow under the barrier without clogging.

Other forms of temporary barriers may be considered. The design for other barrier types or the proposed use of proprietary barriers, however, must be submitted to the Illinois Tollway's Engineering Department for review and acceptance.

3. Use of Barriers - Applications for when barriers may be warranted are discussed in Section 7, Use of Positive Protection Devices.
4. Placement Considerations - Barriers shall not be used as channelizing tapers where merging is required. In such instances the lane should be closed using channelizing devices, such as barricades, to provide recovery space before the barrier is introduced.

Barriers are most effective when they are placed essentially parallel to traffic flows. However, when conditions are such that they are placed on a flare with the downstream end toward traffic, the rates shown in Table 1 in Article 6.4.7.5(e) shall be used.

The upstream end of barriers shall be treated in such a way as to preclude impact. This can be accomplished by flaring the barrier away from the travel path to a point well outside the clear zone. The preferred treatment is the use of a NCHRP 350 or MASH approved impact attenuators at the exposed end.

When a temporary barrier is placed such that it longitudinally abuts another barrier system, such as a guardrail or a bridge rail, a structural connection that meets NCHRP 350-Test level 3 or MASH Test Level 3, shall be provided to form a continuous barrier system with a smooth face in the direction of traffic flow.

5. Barrier Installation
When installing a TCB, a certain amount of space must be provided behind the barrier. This space allows for lateral deflection of the barrier in the event of an impact from an errant vehicle. The amount of space needed behind the barrier depends on the design of the barrier being installed.

Construction strategy consideration shall be given to worker or equipment exposure when a particular construction activity will encroach within the barrier clearance distance. Providing concrete anchoring systems may be desirable based on the distance and time

that workers or equipment are present within this zone along with the Longitudinal Drop-Off Policy discussed in Section 8.

TCB is to be seated on bare, clean pavement or paved shoulder and cross-bolted together in a smooth, continuous line. TCB is not to be anchored on new bridge decks or bridge approach slabs. Where alternate anchoring details are necessary, these should be shown on the plans. The barrier unit at each end of the installation shall be secured to the pavement or paved shoulder using six anchoring pins. This anchorage is necessary to establish the required tension in the barrier system. The end barrier unit facing oncoming traffic shall be shielded with a temporary impact attenuator listed as Severe Use on IDOT's APPROVED LIST OF IMPACT ATTENUATORS, TEMPORARY, meeting the requirements of NCHRP 350 Test Level 3 or MASH Test Level 3.

Additional segment anchorage will be required for conditions where barrier clearance distance cannot be met. There are several anchoring systems for use to prevent overturning and lateral deflections greater than those obtained during the MASH tests based on varying conditions.

Barriers located on bridge decks shall be restrained as shown in the plans. Anchor pins shall not be installed through new bridge decks or on bridge approach slabs.

TCB has several critical components to perform properly:

- a. Lateral Deflection. See Article 1.3 for definition.
- b. Barrier Clearance Distance. See Article 1.3 for definition.
- c. Minimum Deployment Length. Minimum assembly of 8 longitudinal concrete barrier segments (100 feet) excluding terminals or end anchorage devices is required for any continuous run of TCB to perform as tested under NCHRP 350 or MASH criteria.
- d. Shy Distance. A 1 foot (minimum) or 2 foot (desirable) offset from the travel lane to the TCB for one-way traffic.
- e. Flare Rate. The flare rate for temporary precast concrete barriers shall be determined based upon the following:

Table 1
Suggested Flare Rates for TCB

Work Zone Speed (mph)	Shy Line (ft.)	Barrier Inside Shy Line	Barrier at or Beyond Shy Line
65	8.5	28:1	19:1
60	8	26:1	18:1
55	7	24:1	16:1
50	6.5	21:1	14:1
45	6	18:1	12:1
40	5	16:1	10:1
35	4.5	15:1	9:1
30	4	13:1	8:1

- f. TCB Quality. TCB shall conform to requirements in the Illinois Tollway’s “Quality Standard for Work Zone Traffic Control Devices” current edition.
 - g. Barrier Anchorage. The anchorage of TCB to new pavement other than the end units is not allowed.
6. Temporary Concrete Barrier Anchoring Systems
- a. Free-Standing
Free-standing TCB placement consists of the end and transition barrier units being anchored. The remaining units, which are attached together by a cross-bolt type connection, are set atop pavement. The barrier clearance distance to be provided for this system is 3’- 6”.
 - b. Anchor Bolt
When overturning and lateral deflections cannot be tolerated, the TCB system must be anchored to the bridge deck or concrete pavement. Adequate barrier clearance distance from edge of unprotected deck or pavement drop-off shall be maintained for the type of anchorage system provided. Each barrier segment anchorage shall be installed through holes on the lower portion of the traffic side face of the barrier to constrain deflection. The barrier unit at each end of the installation run shall be secured to the pavement, deck or paved shoulder using six anchoring pins. Barriers located on bridge decks shall be restrained as shown in the plans. Anchor pins shall not be installed through new bridge decks or on bridge approach slabs. The Designer shall provide design details indicating the minimum edge distance placement, method of anchorage and barrier clearance distance.
 - c. HMA Pin Assembly.
On projects with HMA pavement material, epoxy bolt anchoring systems cannot be used because of the different mechanical properties of the bolts when placed in asphalt compared to concrete. On these projects, where barriers are needed closer to the obstacle, the barriers are to be installed with an asphalt barrier pin

assembly. Each barrier segment anchorage shall be installed through holes on the lower portion of the traffic side face of the barrier to constrain deflection. When connected to free-standing TCB there exists a need for a transition in the relative stiffness and deflection of the systems. The free-standing TCB shall have an upstream and downstream transition anchoring the barrier segments into the pavement. The Designer shall provide design details indicating the minimum edge distance placement, method of anchorage and barrier clearance distance.

- d. Temporary Concrete Barrier Anchor Layout Transitions.
 - i. Anchored TCB to Free-Standing TCB transition shall be provided when anchored and free-standing TCB are connected. The transition from anchored to free-standing TCB shall consist of two anchor pins installed in the end holes on the traffic side of the first TCB beyond the anchored TCB section and one anchor pin installed in the middle hole on the traffic side of the second TCB beyond the anchored TCB section. The third TCB beyond the anchored TCB section shall then be unanchored. At a minimum, this transition is required at each end of a TCB installation (See Figure 3).
 - ii. Free-Standing to Rigid Concrete Barrier
When a free-standing TCB system is connected to a rigid barrier, such as a concrete parapet or median barrier, there exists a need for a transition in the relative stiffness and deflection of the systems. The free-standing TCB shall have an upstream transition anchoring the barrier segments into the pavement. The end barrier in this transition section shall be connected to the rigid section with a structural connection that meets NCHRP 350-Test level 3 or MASH-Test Level 3. The Designer shall provide design details indicating the minimum edge distance placement, method of anchorage and barrier clearance distance.

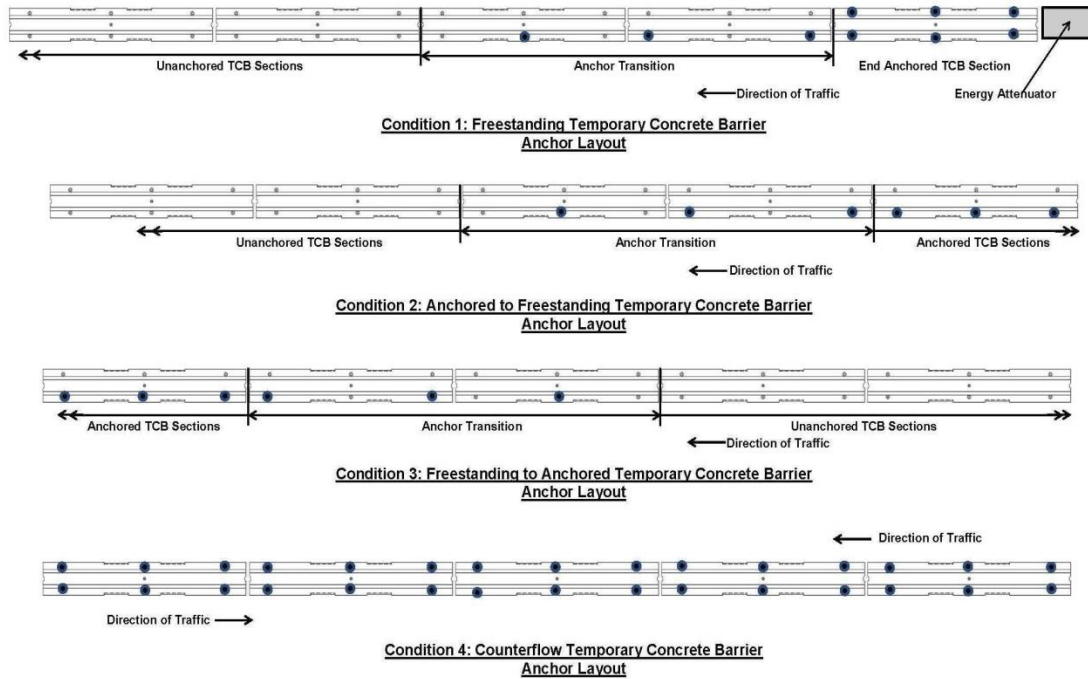

Figure 3

7. Proprietary Temporary Traffic Barrier (PTTB)

A proprietary temporary traffic barrier (PTTB) may be used for work zones or lane separation situations. The required barrier clearance distance shall be based upon the dynamic deflection exhibited in the manufacturer's MASH crash testing results. When free-standing installations are used, the barrier clearance distance required for roadway excavation edge drop-offs, and equipment and material storage locations shall be based on the MASH Test level 3 dynamic lateral deflection. MASH Test Level 3 tested anchoring systems may be used to reduce the above barrier clearance distance, dependent on manufacturer's recommendation. The Designer shall provide design details indicating the minimum edge distance placement, method of anchorage and barrier clearance distance. PTTB shall not be anchored into new bridge decks and approach slabs.

8. Temporary Concrete Barrier Dual Runs

When two runs of TCB are diverging from a point, the blunt ends shall be shielded by an Impact Attenuator, Temporary (Severe Use, Wide), TL-3. The wide impact attenuator width shall cover the entire width of TCB ends.

9. Temporary Guardrail

Temporary guardrail must meet current Illinois Tollway Standards for steel plate beam guardrail. Existing guardrail in satisfactory condition may be extended as long as the temporary guardrail matches in design the system to which it attaches and a proper barrier warrant has been completed. Once the temporary guardrail system is no longer in use, the entire guardrail system must be removed and replaced, if necessary, with a new guardrail installation which meets current Illinois Tollway Standards. Existing guardrail system with steel block-outs may not be modified or extended.

10. Remove and Reinstall Existing Guardrail

The Illinois Tollway allows the temporary removal and reinstallation of a small (< 50') section of existing guardrail when all of the following conditions have been met:

- a. The location of the removed guardrail provides temporary access for the Contractor to get equipment or materials to a work area.
- b. It is either impractical or very difficult for construction equipment to go around the entire guardrail system.
- c. When the existing run of guardrail is not the current Illinois Tollway guardrail system, then the rehabilitation of the adjacent roadway, or the replacement/upgrade of the existing guardrail shall be programmed within the next five years.
- d. The existing run of guardrail (including terminals) meets NCHRP 350 or MASH Test Level 3 criteria.
- e. Full tension capability is re-established to the guardrail system.
- f. Opening location shall be shielded as described below in Condition 2.

Once a rail section(s) of guardrail is removed, the guardrail system no longer functions as designed. It is essential that the full tension capability is re-established to the guardrail system. When this operation is being performed, the following measures may be considered based on the configuration of traffic control devices utilized for the project's maintenance of traffic.

Condition 1.

Work that occupies this opening location shall require the use of temporary warning devices, such as drums for either of the following situations:

- i. Short-Term Stationary Work which is daytime work that occupies a location for more than 1 hour within a single daylight period.
- ii. Stationary Work which is performed during either daytime or nighttime that occupies a location for more than 1 hour while workers are continuously present.

When lanes of traffic are open adjacent to the guardrail affected, the shoulder shall be closed using Illinois Tollway Standard Drawing E3. Temporary warning devices, such as drums or other devices, in accordance with the MUTCD, Part 6, Temporary Traffic Control, shall be placed a minimum of 1500' in advance of the opening and along the entire length of the affected guardrail run.

Upon completion of work and within the time period cited above, the standard section(s) of guardrail shall be reinstalled and the full tension capability shall be re-established to the guardrail system.

Condition 2.

Work that occupies this opening location shall require the use of TCB with an appropriate end impact attenuator to shield the work area for the following situations:

- i. Intermediate-Term Stationary Work is work that occupies a location for more than 1 daylight period up to 3 days.
- ii. Long-Term Stationary Work is work that occupies a location for more than 3 days.

The Designer shall provide details in the MOT Plans. The end guardrail posts at each side of the opening shall be replaced with a temporary traffic barrier terminal compatible with the system affected which allows for the restoration of the full tension capability to the remaining guardrail system.

Upon completion of work, the temporary barrier terminal assemblies shall be removed, the standard section(s) of guardrail shall be reinstalled and the full tension capability shall be re-established to the guardrail system.

6.5 Pavement Markings

6.5.1 Background

It must be recognized that drivers gain a great deal of guidance information from "reading the pavement," and pavement markings are a highly effective means of indicating paths to be followed. They can provide a most useful backup form of information in instances where channelizing devices are knocked down. Pavement markings shall be installed so as not to be in conflict with other traffic control devices.

6.5.2 Requirements

1. Long-term Projects - For long-term projects pavement markings shall be modified to provide safe and orderly traffic flow through the work zone. Conflicting pavement markings shall be removed, covered, or obliterated as soon as practical following any change in traffic lanes and appropriate pavement markings installed as needed.
2. Other Activities - For intermediate-term projects and other short-term operations it may be impractical to modify pavement markings. In such instances sufficient traffic control devices shall be used to provide a clear indication of proper travel paths. One means of mitigating pavement marking conflicts is to reduce the spacing of channelizing devices to form a channelizing pattern that is very dominant.

6.5.3 Materials

Temporary pavement markings using standard permanent materials should be applied to surfaces to be removed in subsequent stages of a multi-stage project, or especially long-term projects where weather and operations such as snow removal may become factors. Temporary marking materials should be used on surfaces to remain in place at the completion of the project. When such materials are used, however, they must be maintained in good condition. Temporary marking materials shall be pressure sensitive tapes (both degradable and otherwise) unless staging extends over the winter months.

6.5.4 Pavement Markings Removal

On Long Term Stationary projects, pavement markings shall be removed, covered with temporary marking materials, or obliterated without unduly damaging the pavement surface. Care must be taken to avoid leaving scars that give the appearance of delineation. Over-painting is not an acceptable method for obliteration, unless that portion of pavement surface will be removed or overlaid in a subsequent stage of construction.

The method of removing pavement markings on east-west roadways needs to be evaluated to account for the visibility issues caused by the varying angle of light from the sun reflecting off the roadway surface. Under these conditions, covering of the existing pavement markings will not be the most effective measure in establishing the temporary lane configurations. Engineering judgment shall be used in determining what measures are appropriate, based on the project's length, duration, and time of year.

6.6 Lighting Devices

6.6.1 General Applications

At nighttime and during periods of inclement weather, such as fog or heavy rainfall, clarity and distance of vision are severely reduced. Reflectorization will only partially compensate for the reduced vision, because it is limited to the adequacy of approaching vehicles' headlights and the condition of the reflecting surface. Independent light sources may be used to warn or guide traffic through the work zone during nighttime and periods of reduced vision. Warning lights, floodlights, rotating lights and beacons, and supplemental sign lighting are included in the list of independent sources which may be used.

6.6.2 Warning Lights

1. Specifications - There are three types of warning lights which may be used. All are defined as portable, lens-directed enclosed lights emitting a yellow color. Detailed specifications for warning lights shall be in accordance with the "Purchase Specifications for Equipment and Material Standards of Institute of Transportation Engineers", Publication No-ST-OI7A, latest edition.

Note that Article 701.04 (f) of the Illinois Tollway Supplemental Specifications requires that during severe weather conditions, "...Contractor personnel shall maintain continuous surveillance...", and as in Article 701.03 (e) of the Illinois Tollway Supplemental Specifications, any lights that are out "...shall be replaced or repaired by the Contractor within 12 hours after notification." The Contractor is responsible for replacing lighting units which have become defective. The Contractor shall be responsible for replacing light batteries on a group basis at such time as may be specified by the CM.

Also, note the requirements of Article 701.03 (e) of the Illinois Tollway Supplemental Specifications for the distances from which the lights must be visible for the various atmospheric conditions, and times of day.

2. Applications - Type A warning lights are low-intensity flashing lights to be used from dusk to dawn. They may be mounted on channelizing devices or advance warning signs to

warn motorists that they are approaching or proceeding through a potentially hazardous area.

Type B lights are high-intensity flashing lights which are effective 24 hours a day.

Flashing lights may be mounted to advance warning signs or on independent supports.

Type C lights are low-intensity steady-burn lights used from dusk to dawn. When warning lights are used on channelizing devices positioned in a series to provide path guidance, they shall be steady-burn lights. Type C lights should be mounted on channelizing devices, as needed.

For nighttime closures, Type II or vertical barricades shall be used with one Type C light per unit for channelizing tapers and separating travel lanes from the work area or other adjacent hazardous areas.

6.6.3 Nighttime Lighting

Nighttime lighting is used on construction and maintenance projects to enable workers to see during nighttime operations. To a more limited extent, they may also enable the approaching motorist to see what is taking place, but are usually not essential to the safe movement of traffic past the work area.

For nighttime flagging and spotting, flaggers and spotters shall be illuminated by an overhead source providing a minimum vertical illuminance of 10-foot candles measured 1 foot out from the flagger's chest. The bottom of any luminaire shall be a minimum of 10 feet above the pavement. Luminaire(s) shall be shielded to minimize glare on approaching traffic and trespass light to adjoining properties. The glare requirements are contained below.

6.6.3.1 Specifications

Reference IDOT Standard Specifications for Road and Bridge Construction, Article 702, Nighttime Work Zone Lighting.

The lighting system shall be designed to meet the following.

1. **Lighting Levels.** The lighting system shall provide a minimum of 5-foot candles throughout the work area. For mobile operations, the illuminated work area shall be defined as 25 feet in front of and behind moving equipment. For stationary operations, the work area shall be defined as the entire area where work is being performed.

Lighting levels will be measured with an illuminance meter. Readings will be taken in a horizontal plane 3 feet above the pavement or ground surface.

2. **Glare Control.** The lighting system shall be designed and operated so as to avoid glare that interferes with traffic, workers, or inspection personnel. Lighting systems with flood, spot, or stadium type luminaires shall be aimed downward at the work and rotated outward no greater than 30 degrees from nadir (straight down).

As a large component of glare, the headlights of construction vehicles and equipment shall not be operated within the work zone except as allowed for specific construction operations. Headlights shall never be used when facing oncoming traffic.

3. Light Trespass. The lighting system shall be designed to effectively light the work area without spilling over to adjoining property. When, in the opinion of the CM, the lighting is disturbing adjoining property, the Contractor shall modify the lighting arrangement or add hardware to shield the light trespass.

The lighting design required above shall be provided at any location where construction equipment is operating, or workers are present on foot. When multiple operations are being carried on simultaneously, lighting shall be provided at each separate work area.

The lighting requirements for specific construction operations shall be as follows.

1. Installation or Removal of Work Zone Traffic Control. The required lighting level shall be provided at each truck and piece of equipment used during the installation or removal of work zone traffic control. Headlights may be operated in the work zone.
2. Milling and Paving. The required lighting level shall be provided by mounting a minimum of one balloon light to each piece of mobile construction equipment used in the work zone. This would include milling machines, mechanical sweepers, material transfer devices, spreading and finishing machines, and rollers; but not include trucks used to transport materials and personnel or other vehicles that are continuously moving in and out of the work zone. The headlights of construction equipment shall not be operated within the work zone.
3. Patching. The required lighting level shall be provided at each patching location where work is being performed.
4. Pavement Marking and Raised Reflective Pavement Marker Removal/Installation. The striping truck and the attenuator/arrow board trucks may be operated by headlights alone; however, additional lighting may be necessary for the operator of the striping truck to perform the work.

For raised reflective pavement marker removal and installation and other pavement marking operations where workers are on foot, the required lighting level shall be provided at each truck and piece of equipment.

5. Layout, Testing, and Inspection. The required lighting level shall be provided for each active area of construction layout, material testing, and inspection. The work area shall be defined as 15 feet in front and back of the individual(s) performing the tasks.

6.6.4 Beacons

Rotating or flashing high-intensity yellow beacons shall be mounted at a minimum height of 7 feet on maintenance, construction, or utility vehicles, and equipment that are operated as part of a moving operation, or that are used as either stationary or moving shadow vehicles. Such lights need not be used, however, if the vehicle displays a functioning vehicle mounted arrow board.

6.6.5 Arrow Boards

An arrow board is defined as a special lighting unit which displays a set of yellow lamps which can flash and/or sequence arrow or pattern to provide highly visible warning messages.

6.6.5.1 Specifications

Arrow boards may be either vehicle or trailer-mounted. They shall be operated by a self-contained power source, either batteries or electric generator, or the vehicle's electrical system when heavy duty components are installed, which can adequately provide the required power.

For short-term stationary work, the trailer mounted arrow board shall be Type B with 13 lamps, and the minimum size shall be 60 inches x 30 inches. For intermediate term stationary work and long-term stationary work, the trailer mounted arrow board shall be Type C with 15 lamps and the minimum size shall be 96 inches x 48. The larger size shall be used for all stationary applications on long-term stationary work. For short-term maintenance closures, truck mounted arrow boards that are 72 inches x 36 inches may be used. The minimum mounting height shall be 6 feet to the bottom of the panel for vehicle-mounted arrow boards and 7 feet for trailer-mounted boards.

6.6.5.2 Applications

The primary use of arrow boards is to supplement a channelizing taper for lane closures. They should be used, as available, for all such short-term maintenance applications. They shall be used for nighttime closures and on all intermediate and long-term construction projects.

Arrow boards are also used when mainline traffic is split around a center lane work area, or at the beginning of a counter-flow lane. Arrow boards shall be used as specified in the MOT Plates for moving operations.

Arrow boards have particularly important application for mobile and short-duration projects and as part of the transitory traffic control that may be required during the installation, modification, or removal of the work zone.

6.6.5.3 Position

The standard locations for arrow boards used to supplement a lane closure are:

1. Approximately 2100 feet in advance of the beginning of the lane closure taper.
2. Approximately one-third of the distance downstream of the beginning of a channelizing taper.

In locating the panel, however, consideration must be given to both the horizontal and vertical alignment of the approach roadway and to the presence of any obstacles that may obstruct its view. The board should be placed in a position which will maximize its upstream visibility. On horizontal curves to the left, it may be desirable to position the board further to the right, if feasible, to place it closer to the axis of vision of approaching traffic. The converse situation applies on curves to the right.

6.6.5.4 Operation

For lane closures, the preferred mode of operation is the flashing (on-off) arrow. For exterior lane closures, the arrow heads shall point in the direction of the open lane(s). When an interior lane is closed, and traffic may pass on both sides of the work area, the double-headed arrow shall be displayed in a flashing mode.

When an arrow board is used for a shoulder closure and no merging maneuver is required, the board should be operated using the caution mode. This pattern commonly consists of only the stem of the arrow or four corners.

The light intensity shall be reduced during nighttime use to avoid glare and returned to full intensity for daytime use. For boards in a stationary position used on long-term projects, this dimming shall be accomplished automatically through the use of photo-electric devices, or equivalent.

6.6.6 Portable Changeable Message Signs

PCMS have the flexibility to display a variety of messages. They are frequently used to provide advance warning and information for highway alignment, traffic or other pertinent information.

The Contractor shall communicate the messages to be shown on the PCMS to the CM, who shall coordinate this with the Traffic Information Management System (TIMS) at least two weeks prior to any change in messages.

Each construction contract shall contain the following:

- Type of PCMS to be used
- Placement/location PCMS are to be used
- Payment schedule

6.6.6.1 PCMS Specifications

There are two types of PCMS approved for use on the Illinois Tollway.

- TIMS compatible three-line PCMS
- TIMS compatible Full Matrix Portable Changeable Message Sign (FMPCMS)

The TIMS compatible three-line PCMS must meet the following specifications:

- 3 line 8 characters per line (18-inch characters)
- Top of sign height when deployed to maximum height – 150 inch minimum
- Solar powered battery charging
- 10-day battery life with no solar assistance
- 70 MPH wind rated
- 30 Degree/1000 feet visible LED design
- Day/night auto brightness
- Waterproof, lockable cabinet for controller
- Password protected software
- 200 message storage capacity
- Remote programmable using internet-based system

- DOT approved trailer with 3-inch opening Lunette Eye
- Provide high-speed internet access for TIMS to access the sign controller
- Must meet the following:
 - MUTCD
 - National Transportation Communication Infrastructure Protocol compliant
 - AASHTO (NTPEP) tested

The TIMS compatible FMPCMS must be one from the Illinois Tollway's Maintenance and Traffic Division's Fleet Unit approved list. Contact the Illinois Tollway's Fleet unit for the approved list of TIMS compatible PCMS.

When TIMS compatible FMPCMS are used, the Contractor shall:

- Provide high-speed internet access for TIMS to access the sign controller
- Provide Automated Vehicle Location tracking for TIMS
- Have all PCMS inspected and approved by the Illinois Tollway's Fleet unit before putting on a job site.

6.6.6.2 Applications

PCMS are required as part of the advance signage for all lane closures or lane shifts of an intermediate or long-term duration. PCMS are also used to supplement other traffic control devices in advising users of unexpected traffic and routing situations or information that may be helpful to the users. (See Project Informational Signs Article 4.3.5) Some applications include:

- Substantial reduction in speed
- Significant delays
- Adverse weather conditions
- Changes in roadway (alignment, surface conditions, etc.)
- Advance notice of closures (This includes complete closures of intersecting roadways, when such is requested by the applicable jurisdiction.)
- Stopped Traffic Ahead

6.7 Other Devices

6.7.1 Attenuators

Temporary impact attenuators are protective systems that aid an errant vehicle from impacting fixed objects or shadow vehicles by either gradually decelerating the vehicle to a stop when hit head-on or by redirecting it away from the feature when struck on the side. These barriers are used for rigid objects or other features that cannot be removed, relocated, or made breakaway. All temporary impact attenuator products shall have fully redirective properties and be tested under NCHRP Report 350-Test Level 3 or MASH at Test Level TL-3. There are two types of temporary attenuators, roadside and truck/trailer mounted (TMA).

For MOT configurations which warrant an additional degree of attention to the attenuator, a supplemental, high-intensity reflector with rotating motion shall be installed.

Temporary impact attenuators, non-redirective, such as water and sand filled barriers shall not be permitted for use in the work zone.

The following systems as classified are appropriate only in work zones or other temporary installations. All proprietary roadside hardware devices must receive FHWA eligibility letters as a crashworthy product. To be considered for use on the Illinois Tollway, a given device must be on the IDOT, Bureau of Materials and Physical Research APPROVED LIST OF IMPACT ATTENUATORS, TEMPORARY as described below:

- **IMPACT ATTENUATORS, TEMPORARY (SEVERE USE, NARROW).**
This category of impact attenuators is for locations where narrow obstacles are present, and frequent impacts are expected and/or where access for repairs would create unacceptable traffic control or operational problems. These crash cushions should retain some residual capacity to absorb additional frontal impacts while awaiting repairs.
- **IMPACT ATTENUATORS, TEMPORARY (SEVERE USE, WIDE).**
This category of impact attenuators is for locations where wide obstacles are present, and frequent impacts are expected and/or where access for repairs would create unacceptable traffic control or operational problems. These crash cushions should retain some residual capacity to absorb additional frontal impacts while awaiting repairs.

Reference Documents (Current Edition):

- IDOT, Approved List for Materials for products.
- Proprietary Manufacturer's Design Guide and Installation Manual.

6.7.2 Lane Channelizers

Vertical panels are used to separate and delineate approved lanes to or from Plaza lanes.

6.7.3 Flexible Delineator Posts

Flexible post-mounted delineators are typically ground-mounted plastic posts with reflective sheeting that are used to delineate roadsides, interchanges, and other areas in which safety is a concern. Flexible delineator posts are designed to withstand multiple impacts, limit damage to the impact vehicle and alleviate the potential for injury to vehicle occupants.

6.7.4 Glare Screens

Glare screens are used to block the driver's view of activities, and or minimize head light and other light that could distract from the driving task. Vertical and horizontal alignment along with lane shifts during MOT shall be evaluated to determine the need during staging operations.

Reference Document (Current Edition):

- Illinois Bureau of Design and Environmental Manual.

6.7.5 Barrier Reflectors

Barrier reflectors are to be installed on temporary concrete barriers, guardrails and parapets as described in Section 701.03(k). of the Illinois Tollway Supplemental Specifications.

6.7.6 Trailer Mounted Radar Speed Display Units

Radar Speed Display Units are to be used in work zones to inform motorists of the posted speed and their actual speed. Radar Speed Display units shall be provided as shown on Illinois Tollway Standard E2 for short term lane closure and one unit shall be provided in each direction for every 2 miles of mainline pavement for all stages where long-term lane closures or lane shifts are required.

6.7.7 Truck Mounted Attenuators

Truck and truck mounted attenuator combinations shall comply with the requirements of NCHRP 350 TL-3 or MASH TL-3 as applicable and as determined by the WZSL, and shall be mounted on a vehicle meeting the recommendations of the attenuator manufacturer.

TMA's shall be provided where specified as work area protective devices. The use of a truck mounted attenuator as a short-duration positive protective device for a roadside obstacle shall only be allowed under temporary emergency conditions as approved by the Engineer as follows:

- For Contractor and Consultant work activities of a duration 15 minutes or less, where the personnel can be safely working off the roadway and vehicle(s) parked off/beyond the paved roadway shoulder, a TMA may be requested.
- For Contractor and Consultant work activities of a duration longer than 15 minutes, where the personnel are required to work on/adjacent to live traffic lanes and vehicle(s) are required to park on the paved roadway shoulder/lanes, a TMA is required.

SECTION 7.0 USE OF POSITIVE PROTECTION DEVICES

Positive protection devices are defined by the FHWA as devices that contain and/or redirect vehicles and meet the crashworthiness evaluation criteria contained in NCHRP Report 350, Recommended Procedures for the Safety Performance Evaluation of Highway Features, 1993, Transportation Research Board, National Research Council.

The use of positive protection devices is to minimize the intrusion of motorized traffic into the work area and other potential roadside obstacles in the work zone. All barriers except permanent rigid barriers will deflect when hit by an errant vehicle. The amount of deflection is primarily dependent on the stiffness of the system. However, vehicle speed, angle of impact, and weight also affect the amount of barrier deflection.

A free-standing barrier, where the base of the interior barriers is placed on a paved surface without physical attachment to that surface is the desired choice for providing protection in a work area and work zone. While some situations allow for placing free-standing barriers, other more restrictive situations require that each barrier be restrained using techniques such as anchoring, pinning, or bolting to the bridge deck or pavement to further limit any lateral barrier movement.

When barriers are crash-tested, it is impossible to replicate the innumerable variations in actual highway conditions. Therefore, barriers are crash-tested under standardized controlled conditions. Barriers are not placed with the assumption that the system will contain or redirect all vehicles in all conditions. They are placed with the assumption that under normal conditions, they may offer an improved safety condition for most collisions.

Exposure control measures should be considered where appropriate to avoid or minimize worker exposure to motorized traffic and exposure of road users to work activities, while also providing adequate consideration to the potential impacts on mobility.

Positive protection techniques, when properly implemented, can help improve safety for workers and the motoring public. However, careful evaluation needs to be exercised before installing positive protection devices. The decision to use positive protection should be based on the best overall management of safety, mobility, constructability, cost, and overall project duration. These guidelines are meant to be coupled with engineering judgment in determining the use of positive protection.

7.1 Typical Positive Protection Devices

The performance level for all types of positive protection device designs are to be crash tested and approved at Test Level 3 (TL3) and are acceptable for use on higher speed roadways under NCHRP Report 350 or MASH Guidelines. The listing of devices shall include, but are not limited to, the following:

1. Temporary Concrete Barrier. TCB is a set of freestanding, precast, concrete segments 12'-6" in length with built-in connection devices. Reference Article 6.4.7 of this MOT MANUAL for anchorage installation guidelines.

2. **Movable Concrete Barrier.** The movable concrete barrier system consists of approximately 3 feet long precast, concrete segments of barrier connected by steel pins to form a barrier wall that is moved laterally with a transport/transfer vehicle. Reference the individual manufacturer's details and specifications for installation requirements.
3. **Steel Shaped Barrier.** The steel shaped barrier system consists of long steel sections which can be interlocked to form a barrier wall. The individual barriers or assembled sections can be raised onto casters with a hand crank or optional compressed air in which the barrier links can be repositioned. Reference the individual manufacturer's details and specifications for installation requirements.
4. **Temporary Impact Attenuators.** Temporary impact attenuators are protective devices that are specifically designed to control deceleration of an impacting vehicle at an acceptable rate. These systems shall have redirective properties such that a vehicle impacting the side of the attenuator is redirected away from the barrier back towards the traveled way. Reference the individual manufacturer's details and specifications for installation requirements.
5. **Temporary guardrail.** Temporary guardrail consists of a metal beam rail with block-outs and metal posts that are the same as those allowed by the Illinois Tollway for its permanent installations. Materials employed for temporary guardrail do not need to be new, although they must be in like-new condition. All temporary guardrail is to be removed upon completion of use after construction. When temporary guardrail is used to extend an existing system, the temporary guardrail must meet the details and standards of the system it is to be connected to. When any modification to an existing guardrail or terminal system is performed and a proper barrier warrant has been completed, the entire barrier installation shall be deemed temporary and completely removed upon completion of use after construction and, if applicable, replaced with a new system that conforms to the current Illinois Tollway Standards. Reference "Traffic Barrier Guidelines" for installation requirements.
6. **Truck /Trailer Mounted Attenuator.** This type of device is a temporary impact attenuator that is mounted on a truck of suitable size, as specified by the manufacturer. It provides attenuation by deformation of cartridges within the attenuator or some other manner of making the impact energy dissipate mechanically.
7. **Balsi Beam.** This protection system is essentially a semi-trailer with two telescoping beams on each side. Each of the beams can be rotated to the other side to stack on the other beam, and provide a double beam barrier on the edge of a live traffic lane. The trailer can be extended to provide a thirty-foot work area, shielded from traffic by the beams. It has its own dedicated tractor truck to transport it to the work area at normal highway speeds without the need for any permits. The system occupies eight feet of lane width, and does not allow large equipment access into the work zone directly from the rear. An adjacent lane or shoulder must be available for vehicles to access the protected work area. Reference the individual manufacturer's details and specifications for installation requirements.
8. **Mobile Barrier Trailer.** The mobile barrier trailer protective system is an integrated, rigid wall trailer that can be used in conjunction with standard semi-tractors to provide improved safety for mobile work environments for personnel at applicable maintenance and

construction sites. It is capable of providing 40-100 feet of mobile positive protection. These units can provide a self-contained work area with integral barrier system, onboard power, lighting, storage, signage, and crash attenuation. It is designed to be driven from site to site at normal highway speeds. Reference the individual manufacturer's details and specifications for installation requirements.

7.2 Measures and Strategies

The types of measures and strategies to be used are not mutually exclusive to all work zones, and should be considered in combination as appropriate based on characteristics and factors such as those listed below:

1. Project scope
2. Project duration
3. Length of construction work zone for roadway, bridge and utility construction or maintenance projects
4. Anticipated traffic speeds through the work zone
5. Anticipated traffic volume
6. Vehicle mix
7. Type of work (as related to worker exposure and crash risks)
8. Distance between traffic and workers and extent of worker exposure
9. Escape paths available for workers to avoid a vehicle intrusion into the work area
10. Time of day (e.g., night work)
11. Work area restrictions (including impact on worker exposure)
12. Consequences from/to road users resulting from roadway departures
13. Potential obstacle to workers and road users presented by device itself and during device placement and removal
14. Geometrics that may increase crash risks (e.g., poor sight distance, sharp curves)
15. Access to/from work area
16. Roadway classification (e.g., mainline, ramp)
17. Impacts on project cost and duration

7.3 Use of Positive Protection Devices

7.3.1 Condition I: Use by Engineering Judgment

The need for longitudinal traffic barrier and other positive protection devices in work zones shall be based on engineering evaluation and judgment to guide the decision-making process. An engineering assessment should be based on consideration of the factors and characteristics described in Art. 7.2 Measures and Strategies.

Exposure along the work zone is directly related to the length of time needed for the construction activity. This is a very important point in the design decisions involving worker safety and the level of necessary protection for the traveling public. Also, the designs for work zones are more restrictive due to limiting alignments and cross-sectional areas. Positive protection devices shall be considered in work zone situations that place workers at increased risk from motorized traffic, and where positive protection devices offer the highest potential for increased safety for workers and road users, under the following conditions:

1. Work areas that provide workers no means of escape from motorized traffic.
 - a. Tunnels
 - b. Bridges
 - c. Narrow Medians
 - d. Others as determined by engineering judgment
2. Roadside obstacles or conditions based on engineering judgment.

The Designer shall provide discussion in the Concept Report under Maintenance of Traffic, Work Zone Conditions where the uses of positive protection devices are to be utilized. This assessment should continue during the project's plan development.

7.3.2 Condition II: Mandatory Use in Work Zones

Positive protection devices shall be utilized under the following work zone conditions:

1. Counter-flow Lanes.

For TCB a desired 3'- 6" barrier clearance distance shall be provided on each side of the barrier. This shall be measured from the toe of barrier to edge of traveled way. When the desired clearance distance is met, the TCB can be installed free-standing.

When the desired barrier clearance cannot be met, the barrier system shall be anchored to the deck/pavement according to the clearance distance requirements for the individual positive protection device being utilized.

2. Longitudinal Edge Drop-Offs.

For TCB, a desired 3'- 6" barrier clearance distance shall be provided behind the TCB. This shall be measured from the toe of the barrier to the edge of drop-off. When the desired clearance distance is met the TCB can be installed free-standing.

When construction equipment or workers encroach within the barrier deflection limit for free-standing units, the barriers may be restrained using appropriate anchoring techniques to limit the lateral movement. The barrier system shall be anchored to the deck/pavement according to the clearance distance requirements for the individual positive protection device being utilized.

Reference: Barrier Installation Article 6.4.7.5 and Section 8.0 - Longitudinal Edge Drop-Off Policy of this document.

3. Mobile Operations; intermittently or continuously.

Positive protective devices such as TMA's, or shadow vehicles, shall be used to close the lane in advance of the work and/or workers. The positioning of the TMA vehicles is dependent on a number of variables which must be assessed for each site location, one of which is the roll-ahead distance. Roll-ahead distance is the distance the shadow vehicle will displace when impacted. The roll-ahead distance is based on the weight of the shadow truck and attenuator, and the speed, and weight of the impacting vehicle. The shadow vehicle should be positioned at a sufficient distance in advance of the workers or

equipment being protected, however not so much that the errant vehicle will be able to travel around into the work area. Reference the manufacturer's details and specifications for recommended distances.

SECTION 8.0 LONGITUDINAL DROP-OFF POLICY

The following conditions have an established course of action which is intended to increase traffic safety using traffic control devices and safety related appurtenances for uneven lanes, milled edges, and edge drop-offs that occur in highway work zones. The best way to increase traffic safety is to minimize exposure to uneven lanes, milled edges, and edge drop-offs. Only when uneven lanes, milled edges, and edge drop-offs are deemed necessary, shall the appropriate portion(s) of this section be applied to enhance traffic safety.

No traffic control treatments are needed if edge lines are installed and shoulder widths and cross section slopes are the same as existing adjacent roadway sections.

Drop-off is a temporary condition defined as an elevational difference between lanes, or the traveled lane and shoulder, as traversed by the wheel of a motor vehicle.

Refer to the General Notes following the various drop-off conditions for more information.

Condition 1

Drop-offs of ≤ 2 inches, between traffic carrying lanes do not require any traffic control treatments. Appropriate traffic warning signs “Uneven Lanes” or “Shoulder Drop Off” shall be posted to identify pavement conditions and shall be spaced 1 mile in urban area, 2 miles in rural areas and at each entrance ramp. At no time shall there be more than one uneven lane condition between the traffic carrying lanes which include auxiliary lanes and ramp access or egress areas. The drop-off location is not to be located outside of 3” from the pavement joint line.

MOT: No Lane Closures

Length of Continuous Drop-Off: Any

Duration: Any

Speed: 45 MPH

Typical Applications:

- Milling Existing Wearing Surface
- Resurfacing Operations

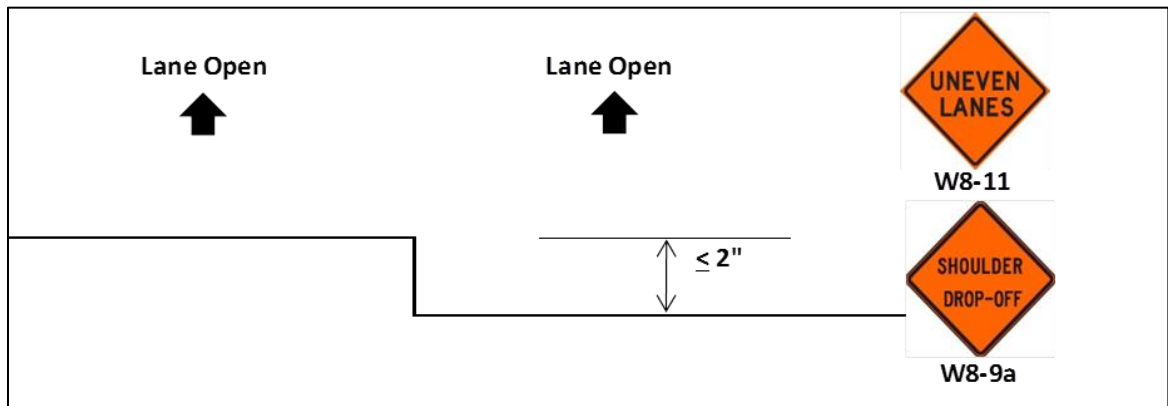

Condition 2

Drop-offs of > 2 to 4 inches, between traffic carrying lanes are permitted with the installation of a temporary HMA wedge. The wedge taper rate shall be ½ inch (V) to 12 inch (H). Tapered slopes shall be adequately compacted to provide a firm driving surface. Traffic warning signs “Uneven Lanes” or “Shoulder Drop Off” shall be posted to identify pavement conditions and shall be spaced 1 mile in urban area, 2 miles in rural areas and at each entrance ramp. At no time shall there be more than one uneven lane condition between the traffic carrying lanes which include auxiliary lanes and ramp access or egress areas.

MOT: No Lane Closures

Length of Continuous Drop-Off: Any

Duration: Any

Speeds: 55 MPH or Less

Typical Applications:

- Resurfacing Operations

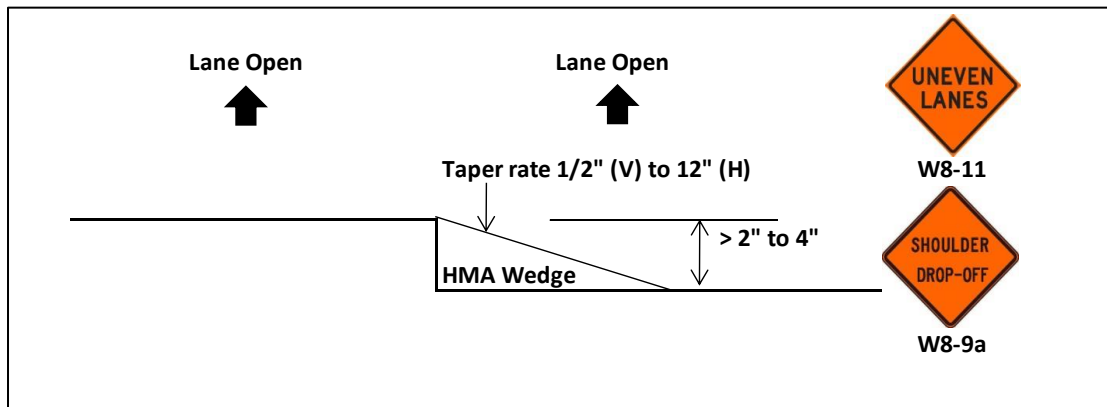

Condition 3

Drop-offs of ≤ 3 inches adjacent to traffic carrying lanes are permitted without tapers or TCB. The minimum distance from edge of traveled way to edge of drop-off is 3 feet. Spacing of traffic control devices shall be in accordance with the applicable Illinois Tollway Standard Drawing.

Note: Illinois Tollway Standard Drawing for Lane Closure (E2) requires check barricades to be placed in the middle of the closed lane and at the shoulder at 1000 feet centers.

MOT:

- Lane Closure, Illinois Tollway Standard Drawing E2
- Shoulder Closure, Illinois Tollway Standard Drawing E3

Length of Continuous Drop-Off: Any

Duration: Any

Speeds: 65 MPH or Less.

Typical Applications:

- Milling Existing Wearing Surface
- Resurfacing Operations

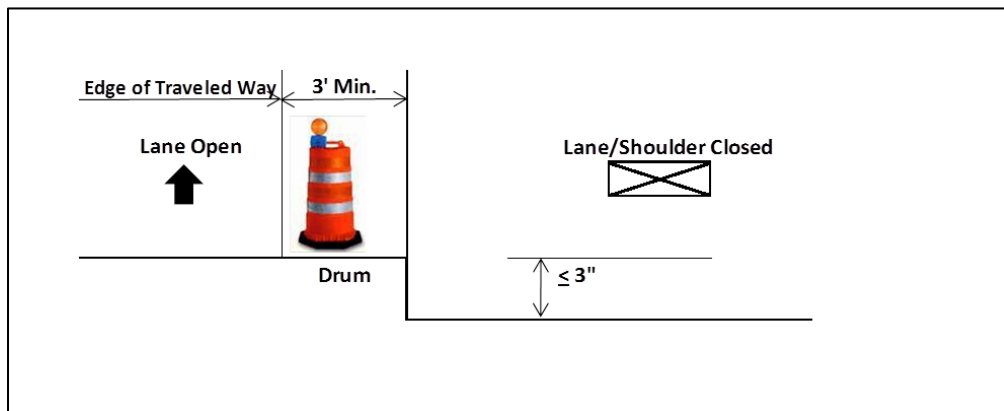

Condition 4

Drop-offs of > 3 inch to ≤ 18 inches adjacent to traffic carrying lanes are permitted without tapers or temporary concrete barriers provided a distance of 3 feet from the edge of traveled way to edge of drop-off is available for the placement of traffic drums or barricades. Spacing of traffic control devices shall be in accordance with the applicable Illinois Tollway Standard Drawing.

When workers or equipment are present 2 feet or less from the edge of traveled way, the lane open to traffic shall be temporarily closed during work activities.

Pavement patching is not considered a drop-off condition, except when individual patching holes are left open in excess of 24 hours.

MOT:

- Lane Closure, Illinois Tollway Standard Drawing E2
- Shoulder Closure, Illinois Tollway Standard Drawing E3

Length of Continuous Drop-Off: Any
 Duration: ≤ 24 Hrs.
 Speeds: 55 MPH or Less

Typical Applications:

- Full Depth Pavement Patching
- Drainage/Utility Excavation
- Bridge Deck Patching

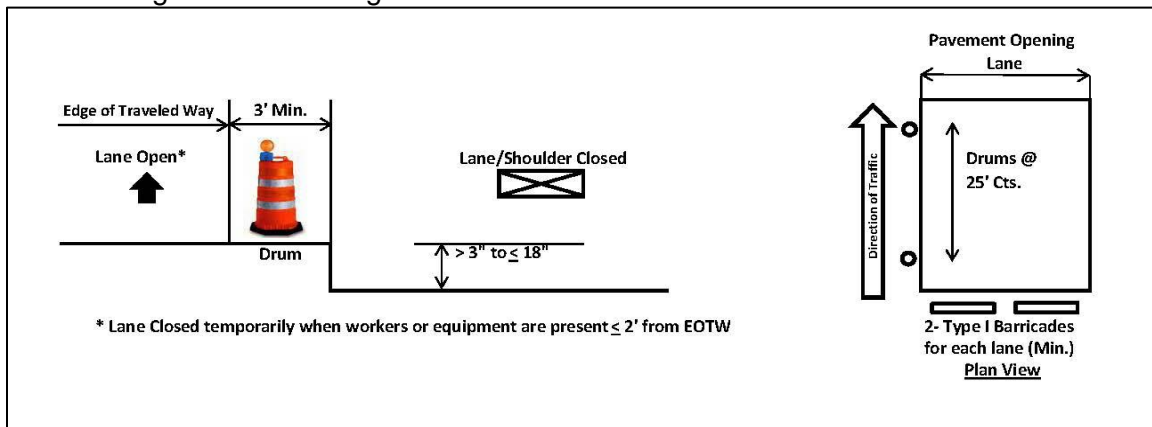

For each pavement opening, Type I barricades shall be placed in front of the opening. A minimum of two (2) Type I barricades shall be installed for each lane. The barricades shall remain for a period beginning immediately after removal is completed and until the curing period for the new concrete pavement has elapsed and all debris has been cleared away or until the excavated depth is less than 3 inches.

Additional drums are to be placed at 25 feet centers adjacent to the drop-off area for a minimum of 100 feet or the length of the drop-off area, whichever is greater.

Condition 5

Drop-offs of > 3 inch to < 12 inches adjacent to traffic carrying lanes are permitted without tapers or temporary concrete barriers provided a distance of ≥ 6 feet from the edge of traveled way to edge of drop-off is available for the placement of traffic drums or barricades. Spacing of traffic control devices shall be in accordance with the applicable Illinois Tollway Standard Drawing.

MOT:

- Lane Closure, Illinois Tollway Standard Drawing E2
- Shoulder Closure, Illinois Tollway Standard Drawing E3

Length of Continuous Drop-Off: Any

Duration: Any

Speeds: 55 MPH or less

Typical Applications:

- Rehabilitation

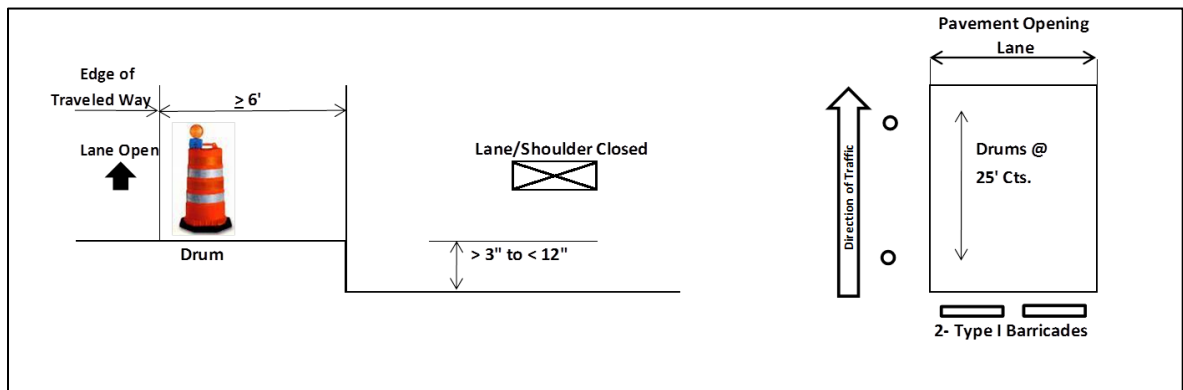

Additional drums are to be placed at 25-foot centers adjacent to the drop-off area for a minimum of 100 feet or the length of the drop-off area, whichever is greater.

Condition 6

When Conditions 3 thru 5 cannot be met, or by engineering judgment, drop-offs of > 3 inches adjacent to traffic carrying lanes are permitted with placement of temporary concrete barriers provided a minimum distance of 3'-10" from edge of traveled way to edge of drop-off is maintained.

Temporary precast concrete barriers, Type F, are required on construction projects for traffic protection whenever existing bridge parapets are removed.

MOT:

- Lane Closure, Illinois Tollway Standard Drawing E2
- Shoulder Closure, Illinois Tollway Standard Drawing E3

When Conditions 3 thru 5 Cannot Be Met or By Engineering Judgment
Speeds: 65 MPH or less

Typical Applications:

- Full Depth Pavement Patching
- Drainage/Utility Excavation
- Reconstruction

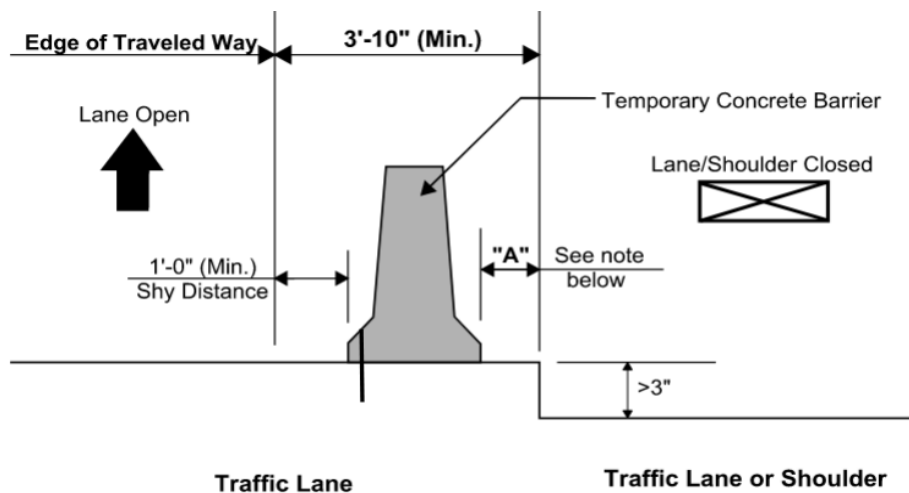

When dimension "A" is less than 3'- 6" the temporary concrete barrier shall be anchored to pavement or deck. Reference Article 6.4.7 of this MOT MANUAL for barrier anchorage systems.

General Notes for Longitudinal Drop-Off Conditions:

1. All traffic control devices shall be in accordance with applicable Illinois Tollway Standard Drawings.
2. Check barricades shall be used as required.
3. A 1-foot minimum shy distance shall be maintained from the edge of traveled way to the traffic control device for Conditions 3 through 6.

SECTION 9.0 INTELLIGENT TRANSPORTATION SYSTEMS & TECHNOLOGY

The goal of Intelligent Transportation Systems (ITS) is to improve the effectiveness, efficiency, and safety of the transportation system. The Illinois Tollway ITS systems manage traffic by using vehicle detectors, closed-circuit television cameras, variable message signs, computer software applications, and graphical display systems. These then aid the Traffic Operations Center (TOC) personnel to manage traffic flow and improve the efficiency of the roadways. The purpose of these systems is to use real-time information to improve the flow of traffic, increase safety, reduce costs, and improve motorist experience along the roadway corridors.

In order to sustain these systems, it is important to have uninterrupted service during construction. Every effort must be made to ensure that existing ITS elements either remain functional during construction, or are temporarily replaced by other ITS equipment. This includes: DMS, Closed Circuit Television (CCTV) elements, Microwave Vehicle Detection Systems (MVDS), Ramp Queue Detection Systems (RQDS), Virtual Weigh in Motion (VWIM) systems and Roadway Weather Information Systems (RWIS). Minimization of disruption of power or communications to the ITS element shall be addressed.

The Designer shall coordinate any removal/relocation and/or installation of ITS elements with the Illinois Tollway Traffic Operations Manager and TOC Manager. These units shall be placed in such a manner as to not become obstacles to the motoring public.

Additionally, if a project includes revised lane configurations or stages which may limit access to ITS devices, the Designer shall coordinate with Illinois Tollway ITS to include contract provisions to address re-aiming MVDS and transfer of maintenance responsibilities for existing ITS devices.

9.1 Removal, Relocation, Calibration, or Storage Procedures

The following procedures shall be adhered to prior to **ANY** Construction phase removal, disconnection, relocation, or alteration of any ITS element, herein referred to as an “outage”.

An ITS element “outage” can be defined as being disconnected from the power source and / or from its communication source (whether wireless or wired), or caused to stop functioning. When an ITS element is relocated, then the power source and communications source need to be reconnected. In some cases, there may be instances when a Fiber Optic cable or a power cable is required to be relocated but the ITS element connected to that Fiber Optic cable or power cable is not removed and relocated. These cases will be handled in a similar fashion as if the ITS element itself were removed and relocated.

ITS Outage or MVDS Stage Change Forms (forms ITS-01 and ITS-02, respectively) are to be filled out and returned to specific personnel (listed on form or as provided by Illinois Tollway PM). These forms are available on the WBPM System, Project 16, under Documents>>Templates and Forms>>ITS Reference Documents. Note that form ITS-01 is applicable to all types of ITS elements and therefore shall be filled out according to the ITS element affected. A separate form shall be submitted for each element affected (only co-located equipment may be listed on a single form). These forms must be submitted into the system within a specified time prior to the work being started.

When temporary locations are determined, the CM shall attach one or more of the following to ITS-01 form to assist in the approval process:

- Plans
- Schematics
- Aerial View

The CM shall obtain from the Contractor and provide to the ITS Unit global positioning system (GPS) locates of temporary locations. The GPS locates shall be in accordance with the ISO 3110 process.

When equipment is permanently removed, then it must be given back to the Illinois Tollway utilizing an A-14 form (Inventory Control Form) available on the WBPM. The CM shall confer with the Illinois Tollway ITS Unit regarding the coordination of equipment transfer.

The ITS-01 outage form shall be submitted to the Illinois Tollway TOC Manager at least 2 weeks prior to the work commencing. Outages during the hours of 5:00 AM – 9:00 AM and 3:00 PM to 7:00 PM are to be avoided. Any changes to the ITS-01 form shall be submitted via email and phone call at least two (2) days prior to work commencing. The CM must call the TOC Manager the day work begins providing an approximate start time and duration of the outage in order to obtain final approval to proceed. The CM must call the TOC just prior to the outage to ensure the ITS element is not actively being utilized for incident management on the Illinois Tollway; if so, the device outage may be postponed by the Illinois Tollway until such time the incident is cleared. After relocation or reactivation of any ITS element, the TOC Manager shall be contacted to confirm proper initial operation of subject devices and all associated equipment. If additional burn-in testing requirements exist, they will be specified in the contract documents and should then be followed.

The ITS-02 (MVDS Stage Change) notification forms shall be submitted to the Illinois Tollway TOC Manager at least 3 days prior to the 21-day MOT meeting. This form is required for any MVDS unit within construction limits and Maintenance of Traffic (MOT) stage change limits, which subsequently will require recalibration to pick up the new traffic lane configurations. The CM shall obtain from the Contractor stage change diagrams and lane configuration cross sections at each MVDS unit to provide at the 21-day meeting, providing these documents electronically to the Traffic Operations Manager and the TOC Manager prior to the 21-day meeting.

The CM shall coordinate with the Contractor to ensure the re-aiming and recalibration of MVDS units is performed for every MOT stage change.

SECTION 10.0 SMART WORK ZONE

The Smart Work Zone (SWZ) is a fully integrated, organic function of the Illinois Tollway's ITS. Prior to the start of construction, the TOC Manager defines one or more SWZs in each direction within a construction zone by choosing to start and end mileposts and configuring the SWZ in TIMS. The TIMS system automatically incorporates all permanent ITS sensors (CCTV, MVDS, RQDS, DMS, VWIM, RWIS) within these milepost limits. Then additional sensors and FMPCMS signs are added to the SWZ as needed to configure a customized solution for the particular work zone. Each FMPCMS is further customized with preselected messages that are triggered by real-time traffic conditions. Any automatic messaging can be overridden by TOC operators as needed. The nearest DMS signs are also configured to provide SWZ messages, if appropriate.

The purpose of this system is to provide advance traffic condition information to motorists at key decision points due to construction activity. The information reported to the public may include an accurate drive time through the work zone, the congestion level to expect or other relevant information. This system shall be in operation 24 hours per day, seven days per week, during the construction period.

The Contractor furnishes, installs and maintains the following components of the SWZ:

- FMPCMS (minimum of 6; 3 in each direction or as directed by the TOC Manager - more for larger work zones as determined by the Designer and TOC Manager).
- Additional non-intrusive traffic sensors (such as Bluetooth sensors as determined by the Designer and Traffic Operation Manager).
- Solar/battery powered CCTV and vehicle detection devices on poles outside of the clear zone or shielded behind barriers where existing fixed ITS equipment offers inadequate coverage.

The Contractor shall repair or replace within 24 hours any SWZ equipment that fails while construction work is in progress. This includes all failures, but especially communication failures, power system failures, sensor failures and Automatic Vehicle Locator failures.

The Contractor shall complete the repositioning of FMPCMS or BlueTOAD unit within the work zone within 4 hours of receiving each request for repositioning from the TOC Manager. The Contractor shall reposition each unit during each stage change as needed.

Any non-crashworthy device must be placed well outside of the clear zone or behind otherwise warranted barrier.

SECTION 11.0 INSTALLATION AND OPERATION OF WORK ZONES

11.1 Installation, Modification and Removal

11.1.1 Need for Expediency

It is important that the installation, modification, or removal of work zones proceed as expeditiously and rapidly as practical to minimize the period of time that workers and motorists alike are exposed to changing conditions. Thorough planning and preparation are necessary prior to performing these functions to ensure that they are performed efficiently and effectively.

11.1.2 Types of Closures

11.1.2.1 Scheduled or Contract Closure

A scheduled or contract closure typically includes a MOT plan that has been previously submitted, reviewed and approved.

11.1.2.2 Daily Closure

A daily closure typically includes most maintenance activities and contract projects that did not require a MOT plan.

11.1.2.3 Permit Closure

A permit closure includes any board approved or construction approved permits such as utility repair/installation or outside agency (IDOT, counties, etc.) coordination project.

11.1.2.4 Emergency (non-incident) Closure

An emergency (non-incident) closure typically involves unanticipated maintenance and contract activities on the roadway where the need to complete is immediate without advance notice. These may include failed pavement or joints that pose a safety concern or repair/replacement of the roadway or appurtenances due to an incident.

11.1.2.5 Emergency (incident) Closure

Typically, an emergency (incident) closure includes any incident occurring on the roadway requiring a lane closure.

11.1.3 Preparation

Each of the following steps should be taken to prepare for an orderly establishment of work zone traffic control. Advance planning, coordination, and scheduling are essential components of the process. The following is intended for construction projects and any other major activities that are either of a long-term nature or will have a significant impact upon traffic operations.

There shall be a clear assignment of responsibility for installing and operating the MOT plan. For maintenance projects, the respective Illinois Tollway Maintenance Section Manager/Supervisor shall be the responsible person. For contract work, the Contractor shall designate a Work Zone Traffic Supervisor who has at least one year of experience directly related to work zone traffic control, to be responsible for MOT in the work zone.

Crew and equipment requirements shall be determined on the basis of a detailed review of the proposed MOT plan. For contract work, the Contractor's responsible person and the CM shall be present at the review.

The equipment and devices to be installed should be checked before the installation to ensure that each device is on hand, in satisfactory condition, clean and ready for field installation. Contractors shall furnish to the CM a list of equipment to be installed so that the devices may be inspected before installation.

The position of traffic control devices at the work zone should be determined before installation. For complex MOT plans it may be necessary to pre-mark on the roadway the proper position for such devices. Pre-marking should be done in advance of installation following prescribed traffic control procedures.

11.1.4 Notification

All parties directly affected by the project shall be notified upon establishment of the project schedule so that their activities can be coordinated with the project. This notification shall state a description of the project, when work will start, where the project is located, direction of travel and lanes involved, and the duration. The Illinois Tollway's Engineering and Communications Departments, Traffic/Permit Technician, Maintenance District Manager, and District 15 ISP shall be included in the notification. Reports of traffic control operations will be issued by the Illinois Tollway to keep all parties informed of current conditions at the work zone after the project is underway.

The Contractors will provide a proposed master plan schedule for lane closures prior to the Notice to Proceed and shall update the plan as necessary.

The Engineering Department Maintenance & Traffic Division ultimately has the final approval for all lane closures. For reviewing and scheduling purposes, a detailed road closure plan must be submitted for all scheduled lane closures (as defined in Article 3.4.) to the Incident Manager 10 days prior to the date of the required closure. Temporary lane closures must be requested through the Traffic/Permit Technician during Illinois Tollway business hours, before 9 a.m. the working day preceding the closure. For contract work, the Contractor shall submit the lane closure to the CM for approval prior to submittal to the Traffic/Permit Technician and CCC. Appendix B includes a sample form used to request lane closures from the CM. The CM will notify, by electronic mail, Traffic/Permit Technician, Communications, Maintenance, Plazas (if necessary), Engineering, TOC, Information Technology, Safety and Training, ISP and others as requested. The following flow chart illustrates the process for non-emergency lane closure notification.

General Process for Lane Closure Notification

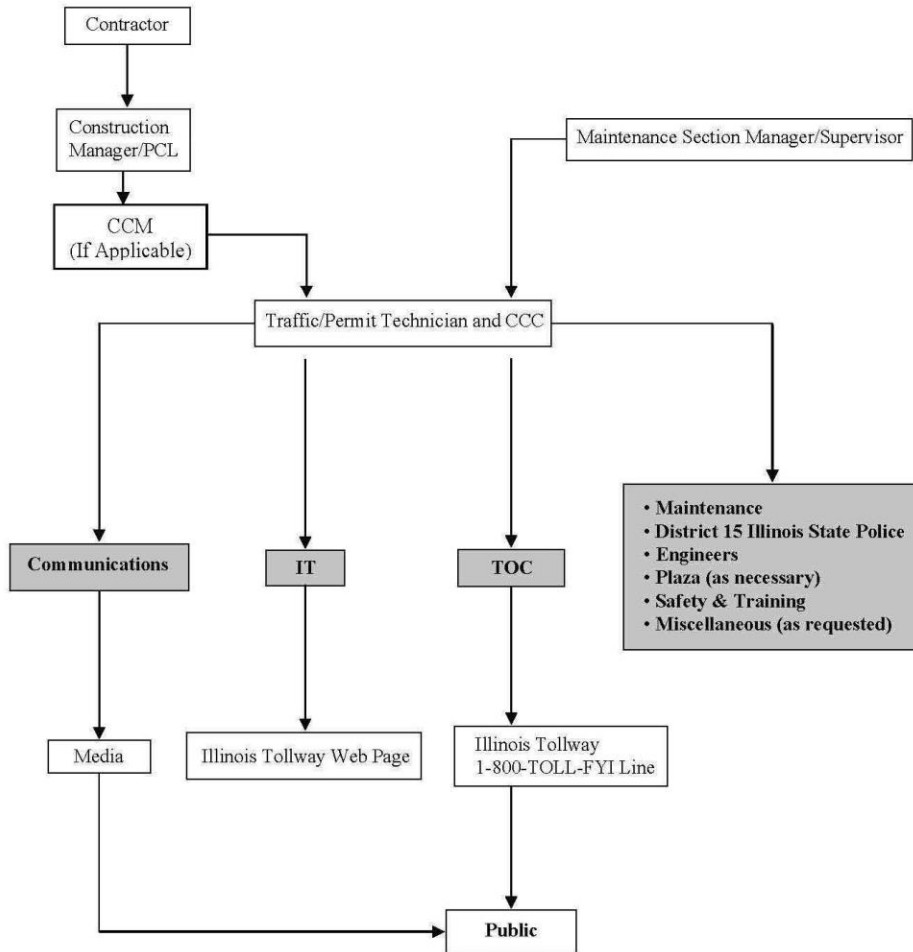

Lane Closure Process Diagram

Figure 4

Emergency (incident) notification is handled by ISP District 15 and on-site maintenance personnel through existing internal Illinois Tollway communication procedures.

11.1.5 Sequence

1. Installation Sequence - The work zone is installed in the direction that traffic is moving. Devices are placed in the Advance Warning Area as the first step. One pass through the area is made to place signs on the right side of the roadway. A second pass is made to place signs on the left side. Reference Figure 2, Elements of a Work Zone Article 5.2.1. Next, the devices in the Transition Area are placed in the downstream direction. When lane closures are involved, the installation of these first two areas should be performed as quickly as practical. The devices in the Activity Area are then installed, again working downstream. Lastly, the devices in the Termination Area are placed. Figure 5 illustrates the procedure for carrying out the center lane closure.
2. Removal Sequence - The removal sequence is essentially the reverse of that employed for the installation process, with one important exception; work vehicles shall not back up in an open lane. Working upstream, the devices in the Termination Area and then the Work Area are picked up. Next, the devices in the Transition Area are picked up with a work vehicle positioned in the closed lane or on the shoulder, if available. Two downstream passes must then be made with traffic to retrieve the signs in the Advance Warning Area first on the left side of the roadway and second on the right side.
3. Modification - Work zones often require modification for each phase of a major project. The modification process is a combination of removal and installation steps. The modification plan shall be devised using the principles set forth above. During such alterations, particular care must be exercised to provide clear instructions to drivers during each step of the modification.

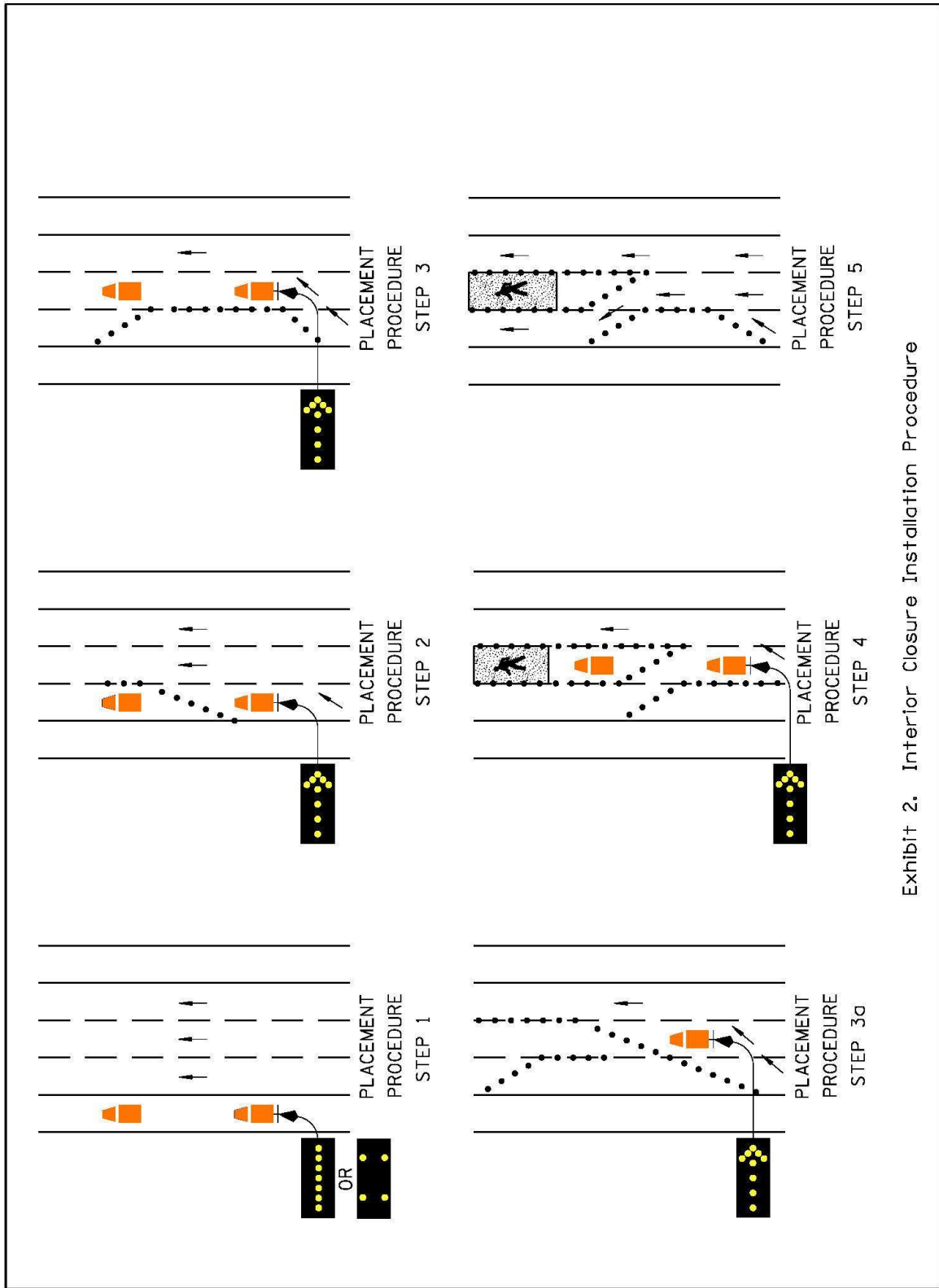

Exhibit 2. Interior Closure Installation Procedure

S:\PROJECTS\boilerplate\8\centerlane\close.dgn

Figure 5

11.1.6 Allowable Lane Closure Schedule

Lane closures should be scheduled during days and times that will minimize the effect to traffic flow. (See Illinois Tollway Lane Closure Reference Guide)

11.1.7 Special Techniques

The setting and retrieving of signs in the Advance Warning Area is basically a moving operation along the shoulder. The MOT Diagram for this operation is given in Plate 8. For installation and removal activities, however, the work vehicle should be equipped with changeable message arrow boards, because they will be used in a variety of situations during the various steps of the process.

When no shoulder is available, the work in the advance warning area becomes an intermittent stop operation. The arrow boards on the work vehicle shall indicate that the outside lane is closed.

To expedite the placement of lane-closing channelizing tapers, directional barricades may be placed from a moving work vehicle. The worker performing this task shall have an adequate platform cage from which to work. The cage shall be securely fastened to the rear of a large stake body truck equipped with a directional arrow board on the truck and the flashing light mounted at 3 feet above pavement on the protective platform. A worker is positioned on the back end of a truck setting out a channelizing taper.

Signs to be installed on semi-permanent supports may be erected in advance and covered until the traffic zone is put in operation. This procedure reduces the time required to establish the advance warning area during installation. The material used to cover signs shall be opaque, securely attached and resistant to tearing under windy conditions.

11.1.8 Ballasting Devices

Ballast may be provided as needed to provide stability for traffic control devices and to enable them to stand under anticipated road and wind conditions. Ballast shall be placed near ground level to minimize the possibility of the ballast hitting the windshield of an impacting vehicle.

Ballast shall be of a type that will spread out over the roadway if the device is demolished by an impacting vehicle. The standard form of ballast is sandbags. During freezing weather provision must be made to prevent the sand from becoming wet and freezing. A waterproof bag covering or chemicals may be used for this purpose.

Portable sign supports and barricades should have ballast added, as needed. Cones should have integral weighted bases. Drums should be ballasted with either sandbags, or weighted collar. Care must be taken to avoid placing excessive weight in drums; sand ballast shall not exceed a depth in the drum of 8 inches.

In no instance shall ballast or warning lights obscure a sign face or a reflectorized surface on a channelizing device.

11.2 Work Zone Evaluation

11.2.1 Evaluation Following Installation

When the installation or modification of a work zone has been completed, its effectiveness shall be evaluated. When practical, this evaluation should be performed before the work area is occupied and work commenced.

For maintenance operations, this evaluation shall be performed by the Illinois Tollway Section Manager/Supervisor. For contract work, the evaluation shall be performed by the CM.

The purpose of the evaluation is to assure that devices have been set out in accordance with plans and that traffic is flowing properly through the control zone. Even though the control procedure is carefully planned, designed, and installed, the real test is that it works well in the field.

Items to be observed during the evaluation process include the following traffic flow characteristics:

- Excessively high or low speeds
- Erratic maneuvers
- Frequent application of brakes, as seen by brake lights
- Skid marks
- Vehicles following improper paths
- Vehicles operating in prohibited area (on shoulders, between channelizing devices, etc.)
- Congestion and backups
- Driver gawking
- Damaged or displaced devices.

When changes in the MOT plan are necessary, they shall be made as soon as practical and the changes shall be properly documented. If the changes made are significant, the work zone shall be re-evaluated after modifications are completed.

11.2.2 Work Zone Performance

All motor vehicle or worker related crashes that occur in a work zone shall be investigated to determine if some modification of the work zone is warranted to reduce the likelihood of a recurrence of a similar crash. Crash investigations should include a field review, an analysis of reports made by traffic officers and drivers, and discussions with knowledgeable persons who were at the work zone. All recommendations for modifications and/or changes to work zones should be forwarded to the Traffic Operations Safety Committee for formal review and subsequent action, if appropriate.

11.3 Maintenance of Traffic Control Devices

11.3.1 Inspection of Work Zones

For intermediate and long-term projects, periodic inspection shall be made to determine that all traffic control devices in the work zone are in place, functioning effectively, and in good repair.

Inspection Responsibility - For contract work, the basic inspection responsibility for maintenance inspections lies with the CM and the Contractor's work zone Traffic Supervisor designated as the responsible person for traffic control. On major activities performed by Illinois Tollway forces, this inspection should be made by the Section Manager/Supervisor. Maintenance inspections shall be made in accordance with the provisions in the Illinois Tollway Construction Manager's Manual.

1. Inspection Frequency - The frequency of inspections should be determined by considering the following factors:
 - a. Project size and duration
 - b. Severity of obstacles
 - c. Frequency at which damage is occurring
 - d. Numbers of deficiencies noted during earlier inspections.
2. Inspection Procedures - The MOT plan (or modified MOT plan) shall be a basic tool for the inspection. When formal plans have not been developed, Illinois Tollway Supplemental Specifications and Illinois Tollway Standard Drawings shall guide the inspection.

The inspection may be made by driving through the work zone or by a walk-through, or both, as needed. All entrance and exit points within the work zone shall be included during the inspection. Accurate inspection records shall be maintained which state deficiencies observed, and when and what corrective measures were taken.

11.3.2 Maintenance

1. Device Maintenance - All traffic control devices within the work zone shall be maintained and kept clean to ensure that they will function as intended.
2. Work Area Maintenance - The work crew and/or Contractor shall maintain the work area in a neat and orderly manner. Travel lanes shall be kept free of dirt and debris.

11.4 Work Operations

11.4.1 Work and Storage Locations

The activities of workers and equipment should be restricted to the designated work area. If it is necessary to operate beyond the work area, the work area and buffer space should be extended to include the activity.

Provisions should be made to move equipment and materials into and out of the work area, as needed. Materials and equipment shall be kept in safe locations when not in use in accordance with the Illinois Tollway Supplemental Specifications, Article 701.06(m).

Storage areas, when placed behind guardrail, must provide for the deflection of rail upon impact. Materials or equipment shall be placed a minimum of 4 feet behind the guardrail posts. When storage areas are located behind temporary concrete barrier, the equipment and materials shall not be stored less than 3'-6" behind toe of free-standing temporary concrete barrier or less than 1-foot behind toe of anchored temporary concrete barrier.

Consideration for the types of materials to be stored need to be assessed. Materials that become projectiles when impacted may present increased chances of harm to workers or to the vehicle occupants.

No storage of any kind is permitted in the recovery area for the Traffic Barrier Terminal Type T1 (Special) or Traffic Barrier Terminal Type T1-A (Special).

Reference Documents (Current Edition): Illinois Tollway Standard Drawings C6 and C12.

11.4.2 Traffic Control during Non-work Periods

During non-work periods, the roadway should be returned to as near normal conditions as practical. Materials and equipment should be removed from the roadway and stored in a shielded location behind guardrail or well outside the clear zone. Traffic Control devices temporarily stored behind existing guardrail shall be stored a minimum of 4 feet behind the guardrail posts.

Reference Document (Current Edition): Illinois Tollway Standard Drawing C1.

No storage of any kind is permitted in the recovery area for the Traffic Barrier Terminal Type T1 (Special) or Traffic Barrier Terminal Type T1-A (Special).

Reference Document (Current Edition): Illinois Tollway Standard Drawing C6 and C12.

Signs which are not applicable shall be removed. All warning lights and other devices not required for nighttime traffic control shall be removed.

1. **FLAGGER Signs** - FLAGGER signs are required in advance of a flagger station whenever a flagger is used to warn traffic. Such signs shall be removed or covered when the flagger is not present.
2. **WORKERS Signs** - WORKERS signs shall be used only when work is being performed at the work area. During non-work periods, these signs shall be removed, covered, or replaced with an appropriate sign.

SECTION 12.0 WORKER PROCEDURES

12.1 General

12.1.1 Recognition of Hazards

Clearly, personnel performing maintenance, construction, and utility operations on the Illinois Tollway are working in a potentially vulnerable environment. Workers must constantly stay alert to surrounding conditions, and carry out their duties so as to protect themselves and the traveling public.

Motorists traveling in a work zone situation may encounter different traffic patterns. These provisions of the MOT MANUAL are designed to provide ample information and adequate notice to accommodate drivers' needs. Workers performing tasks in or adjacent to the roadway must remain aware of surrounding conditions, and diligently install, and maintain traffic control devices in accordance with the procedures set forth in this MOT MANUAL.

12.1.2 Work Zone Practices

Good work habits based on safety awareness provide the best protection available for workers and motorists of the Illinois Tollway. A few fairly simple practices, routinely followed, will nurture these habits, and increase the effectiveness of traffic control in work zones.

The CM personnel must wear proper safety equipment (e.g., hard hat and reflective vest) however they are not responsible for the overall safety of the work zone. The CM is responsible to monitor situations and conditions for contract compliance.

Plan and prepare for any change in traffic control with the objective of completing it as quickly as possible to minimize worker exposure and impact to motorists.

- Check in advance to be sure that necessary devices and equipment are available and in good condition.
- Assign duties in advance and make sure they are understood by all workers.
- Before occupying the site, rehearse the activity to be accomplished, stressing safety at each step of the process.
- If possible, schedule the activity for a daylight off-peak period.
- Carry out traffic control changes in a manner that emphasizes safety for motorists and the workers.
- Always wear proper attire including hard hat.
- Follow Illinois Tollway rules, regulations, and policies for vehicle operation, particularly those covering low-speed travel, distracted driving, use of emergency turnarounds, stopping on the Illinois Tollway, loading and unloading items, and discharging passengers.

- Utilize beacons to increase visibility of work vehicles. Consider use of TMA's (shadow vehicles), arrow boards, and flaggers, as needed, to increase protection while work is in progress.

Carefully inspect traffic control devices and report on their condition when they are returned to inventory upon completion of the work.

12.1.3 Obeying Rules and Regulations

When operating a vehicle on the Illinois Tollway, all operators must abide by the rules and regulations established for the Illinois State Toll Highway Authority. Illinois Tollway policies regarding the use of emergency turnarounds, maintenance operations, equipment and general operating practices shall be followed at all times. At no time will vehicles be permitted to travel against traffic in an open travel lane.

12.1.4 Worker Attire

All personnel on foot within the highway right-of-way shall wear fluorescent orange, fluorescent yellow/green or a combination of fluorescent orange and fluorescent yellow/green garments meeting the requirements of American National Standards Institute (ANSI)/ISEA 107-2004 or ANSI/ISEA 107-2010 for Conspicuity Class 3. These garments shall have a manufacturer's tag identifying them as meeting the aforementioned requirements. For nighttime operations, flaggers shall be equipped with full-body garments meeting these requirements.

Hard hats shall be worn by all persons in a work zone.

12.2 Flagging and Spotting

12.2.1 Flagging and Spotting Functions

Closures on the Illinois Tollway are affected through the use of signs and channelizing devices.

A flagger could be used as needed to assist with special operations of a short-term nature, such as the following:

- Installing, relocating, and removing traffic control devices,
- Moving equipment or materials into and out of the work area.

A spotter could be used as needed to provide support to workers by monitoring traffic in the vicinity of work activities who may need to take evasive action from a roadway hazard.

12.2.2 Flagging and Spotting Devices

The standard device to be employed by a flagger is the SLOW paddle mounted on a staff. Sign paddles shall be fabricated with a SLOW sign face, following the design specification set forth in the MUTCD.

When a two sided "STOP/SLOW" paddle is used, the "STOP" text shall be covered.

Flaggers are not permitted to stop traffic on the Illinois Tollway mainline, and the stoppage of traffic on ramps will not be allowed without the prior approval of the Illinois Tollway Maintenance & Traffic Division. When it is necessary to halt traffic on the Illinois Tollway, District 15 Police are required to assist in this operation.

Spotters should be equipped with a loud warning device (such as an air horn) that can be identified by workers so that evasive action can be taken.

12.2.3 Flagging & Spotting Procedures

The signaling methods used by flaggers and spotters shall comply with those contained in the IDOT's "Flagger Handbook".

12.2.4 Flagger & Spotter Training

Prior to being assigned duties as a flagger or spotter, personnel shall be trained in flagging & spotting responsibilities and procedures. For Illinois Tollway personnel, flagger & spotter training will be stressed periodically as part of routine safety meetings to ensure that all persons involved in flagging & spotting are capable of performing the function safely and effectively. Contractors are responsible for training other personnel in proper flagging & spotting techniques before such persons are assigned to field operation. Flaggers & spotters shall be certified by IDOT or by an agency approved by IDOT. Each flagger & spotter shall have in their possession a current driver's license and current flagger certification ID meeting IDOT requirements. For non-drivers, the Illinois Identification Card issued by the Secretary of State will meet the requirement for a current driver's license.

Persons assigned as flaggers & spotters shall have good vision and hearing and be in good physical condition. Other requisite attributes are reliability, alertness and good judgment.

SECTION 13.0 MAINTENANCE OF TRAFFIC PROCEDURES

13.1 Use of Plates

MOT Plates are presented in this section to illustrate the principles set forth in the MOT MANUAL for moving operations, emergency situations and typical temporary closures. The traffic control situations depicted cover a range of work operations commonly encountered. The work zones shown represent typical solutions. In application, adjustments may be required to accommodate field conditions.

13.2 Description of Plates

The MOT Plates are contained in Section 15 of this MOT MANUAL as individually numbered Plates. Each plate refers by number to General Notes. The General Notes are also presented in Section 15, preceding the Plates. In addition, special notes are provided as part of the Plates. The Plates are not drawn to scale. All signs shall be 48" x 48" unless otherwise indicated on the diagram.

13.2.1 Off Road Activities

When activities are at all times out of the shoulder or median and more than 15 feet from the edge of the pavement, no traffic control procedures are required.

Plate 1 illustrates the traffic control devices for off-road activities that are performed 15 feet or more from the edge of pavement (EOP), but do not encroach upon shoulders or travel lanes. When the work is being done only on the outside (right side) of the roadway, signs are only required on the right side of the roadway. When work is being done in the median area, signs shall be placed on both sides of the roadway.

13.2.2 Shoulder Closure

Plate 2 shows the work zone for work activities on the right shoulder. Devices are only required on the right side of the roadway. For left shoulder closure, devices are only required on the left side of the roadway.

13.2.3 Mainline Lane Closures

Plates 3R and 3L illustrate the traffic control devices for a typical temporary one lane closure. Plate 3R shows the right lane closure and Plate 3L shows the left lane closure.

Plates 4R and 4L illustrate the traffic control devices for typical temporary two lanes closure. Plate 4R shows the two right lanes closure and Plate 4L shows the two left lanes closure.

13.2.4 Ramps

1. Ramp Closures - When work is performed on one-lane ramps and there is insufficient width for maintaining traffic, the ramp should be closed. Appropriate signs should be

placed on the Illinois Tollway mainline when an exit ramp is closed and upon the connecting roadway when an entrance ramp to the Illinois Tollway is closed.

2. Acceleration Lane Closures - If an acceleration lane is closed, the procedure to be used is shown in Plate 5. The right lane is closed upstream so that it may be used as an acceleration lane at the entrance point.
3. Deceleration Lane Closure - When one lane of a two-lane exit ramp is closed or if work must be performed within the deceleration lane for such a ramp, the procedure to be used is shown in Plate 6 and Plate 6A.

13.2.5 Toll Plazas

Plate 7 illustrates a closure in a mainline conventional toll plaza upstream of the toll gates. Where a distance of 300 feet or more is available between the end of the work area and the toll gates, the closed lane(s) may be reopened if needed. When a single lane is closed, the channelization taper should be placed to direct traffic in the closed lane to the side with the greater number of lanes available.

For lane closures beyond the toll gates, the lane should be closed by closing the upstream toll gate and channelization devices should extend from the toll plaza through the work area.

13.2.6 Moving Operations

1. Shoulder - Plate 8 illustrates a moving operation on the right shoulder. A similar procedure may be used on left shoulders when sufficient width is available for vehicles to travel on the shoulder. The adjacent lane shall be closed when insufficient width is available for vehicles to travel on the shoulder.
2. Single Lane - Plate 9R illustrates a moving operation in the right lane and Plate 9L illustrates a moving operation in the left lane.
3. Double Lane – Plate 10R illustrates a moving operation involving two right lanes. And Plate 10L illustrate a moving operation involving two left lanes.

13.2.7 Emergency Situations

Plate 11R depicts emergency closure techniques for the right lane and Plate 11L depicts emergency closure techniques for the left lane. Plates 12R and 12L depict emergency closure for the two right lanes and the two left lanes, respectively. Such work zones are usually installed under less than desirable conditions without the benefit of advance planning. These are usually short-duration closures. To enable the work zone to be installed rapidly and to minimize the number of devices that are kept on hand for emergency closures, the Plates call for fewer devices than are specified for normal lane closures. Signs are placed only on the side of the roadway being closed.

13.2.8 Mainline ORT Maintenance

Plates 13, 14 and 15 cover maintenance in the ORT lanes which requires the temporary full closure of all through lanes at mainline toll plazas. This closure is accomplished with the use of

mobile operations by Illinois Tollway maintenance or Contractor vehicles. The existing roadway traffic is paced as the mobile operation vehicles are slowly set into a stationary position, each coming to a complete stop at strategic points in advance of the toll plaza's monotubes which support the electronic tolling equipment. All roadway traffic is temporarily routed onto the manual side of the toll plaza.

SECTION 14.0 QUALITY STANDARDS – TRAFFIC CONTROL DEVICES

Traffic controls are a necessary part of highway work zones to warn motorists of obstacles, advise them of the proper path through the work zone, delineate areas where they may not operate, and to separate them from the workers. This is accomplished by the deployment of a system of devices. The success of this system depends on the quality of each device and its placement.

Reference Document (Current Edition): “Quality Standard for Work Zone Traffic Control Devices”.

SECTION 15.0 MAINTENANCE OF TRAFFIC PLATES AND NOTES

15.1 General Notes for the MOT Plates

Note 1

No signs and channelizing devices are required when all vehicles, equipment, workers or their activities are at all times out of the median and more than 15 feet from the EOP.

Note 2

The shoulder shall be closed when a work activity requiring 15 or more minutes is performed at a distance which is less than 15 feet but not closer than 2 feet from the EOP.

Note 3

When persons or equipment occupy the shoulder for brief periods of time (less than 15 minutes), the equipment itself or a supplementary vehicle placed upstream of the operation shall show a flashing amber beacon or an arrow board displaying the caution mode (non-directional).

Note 4

The adjacent exterior lane shall be closed when work is performed within 2 feet from the EOP.

Note 5

Any unattended obstacle or excavation left on the shoulder overnight shall be shielded by TCB.

Note 6

If the closure is expected to produce traffic backups extending beyond the first warning sign shown, use additional upstream signs, PCMS or shadow vehicle so that the work zone will encompass the anticipated backup.

Note 7

When the closure is expected to extend into darkness, Type II barricades with steady-burning Type C lights shall be substituted for cones.

Note 8

Sign placement should conform to the following guidelines wherever possible:

1. Temporary signs or signs mounted on barricades – a minimum of 2 feet from the adjacent travel lane and a minimum of 2 feet above the pavement elevation.

2. Post-mounted signs – a minimum of 2 feet from the edge of the shoulder and a minimum of 7 feet above the pavement.

Note 9

Wherever the closure is of duration greater than 4 days, solid white and/or yellow reflectorized pavement marking tape should be placed in addition to drums and/or barricades at the direction of the CM.

Note 10

Short duration and Maintenance closures do not require speed reduction or end of work zone signing.

Note 11

In case of discrepancy between the contract document and this guideline, the Contractor shall follow the contract document.

15.2 Plates 1 Through 15

PLATE 1	NO CLOSURE REQUIRED
PLATE 2	TYPICAL TEMPORARY SHOULDER CLOSURE
PLATE 3R	TYPICAL TEMPORARY RIGHT LANE CLOSURE
PLATE 3L	TYPICAL TEMPORARY LEFT LANE CLOSURE
PLATE 4R	TYPICAL TEMPORARY TWO RIGHT LANES CLOSURE
PLATE 4L	TYPICAL TEMPORARY TWO LEFT LANES CLOSURE
PLATE 5	TYPICAL TEMPORARY WORK ON ACCELERATION LANE
PLATE 6	TYPICAL DECELERATION LANE AND/OR RAMP LANE CLOSURE
PLATE 6A	TYPICAL DECELERATION LANE CLOSURE
PLATE 7	TYPICAL WORK IN TOLL PLAZA
PLATE 8	TYPICAL MOBILE OPERATION ON SHOULDER
PLATE 9R	TYPICAL MOBILE OPERATION-SINGLE RIGHT LANE CLOSURE
PLATE 9L	TYPICAL MOBILE OPERATION-SINGLE LEFT LANE CLOSURE
PLATE 10R	TYPICAL MOBILE OPERATION-TWO RIGHT LANES CLOSURE
PLATE 10L	TYPICAL MOBILE OPERATION-TWO LEFT LANES CLOSURE
PLATE 11R	TYPICAL RIGHT LANE CLOSURE-EMERGENCY SITUATION
PLATE 11L	TYPICAL LEFT LANE CLOSURE-EMERGENCY SITUATION
PLATE 12R	TYPICAL TWO RIGHT LANES CLOSURE-EMERGENCY SITUATION
PLATE 12L	TYPICAL TWO LEFT LANES CLOSURE-EMERGENCY SITUATION
PLATE 13	PLAZA MAINTENANCE FULL ORT CLOSURE-TWO LANES
PLATE 14	PLAZA MAINTENANCE FULL ORT CLOSURE-THREE LANES
PLATE 15	PLAZA MAINTENANCE FULL ORT CLOSURE-FOUR LANES

15.2.1 PLATE 1 - NO CLOSURE REQUIRED

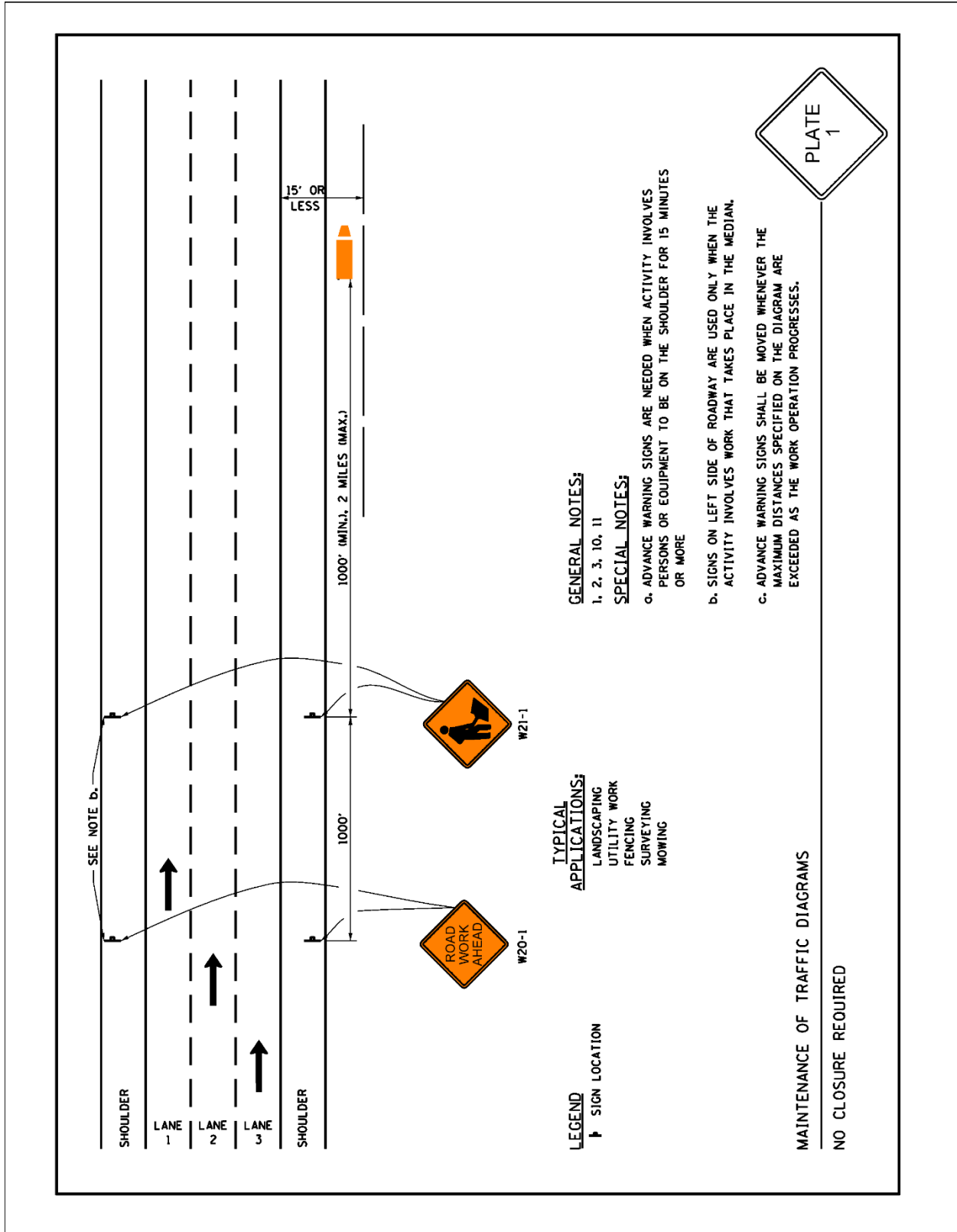

15.2.2 PLATE 2 - TYPICAL TEMPORARY SHOULDER CLOSURE

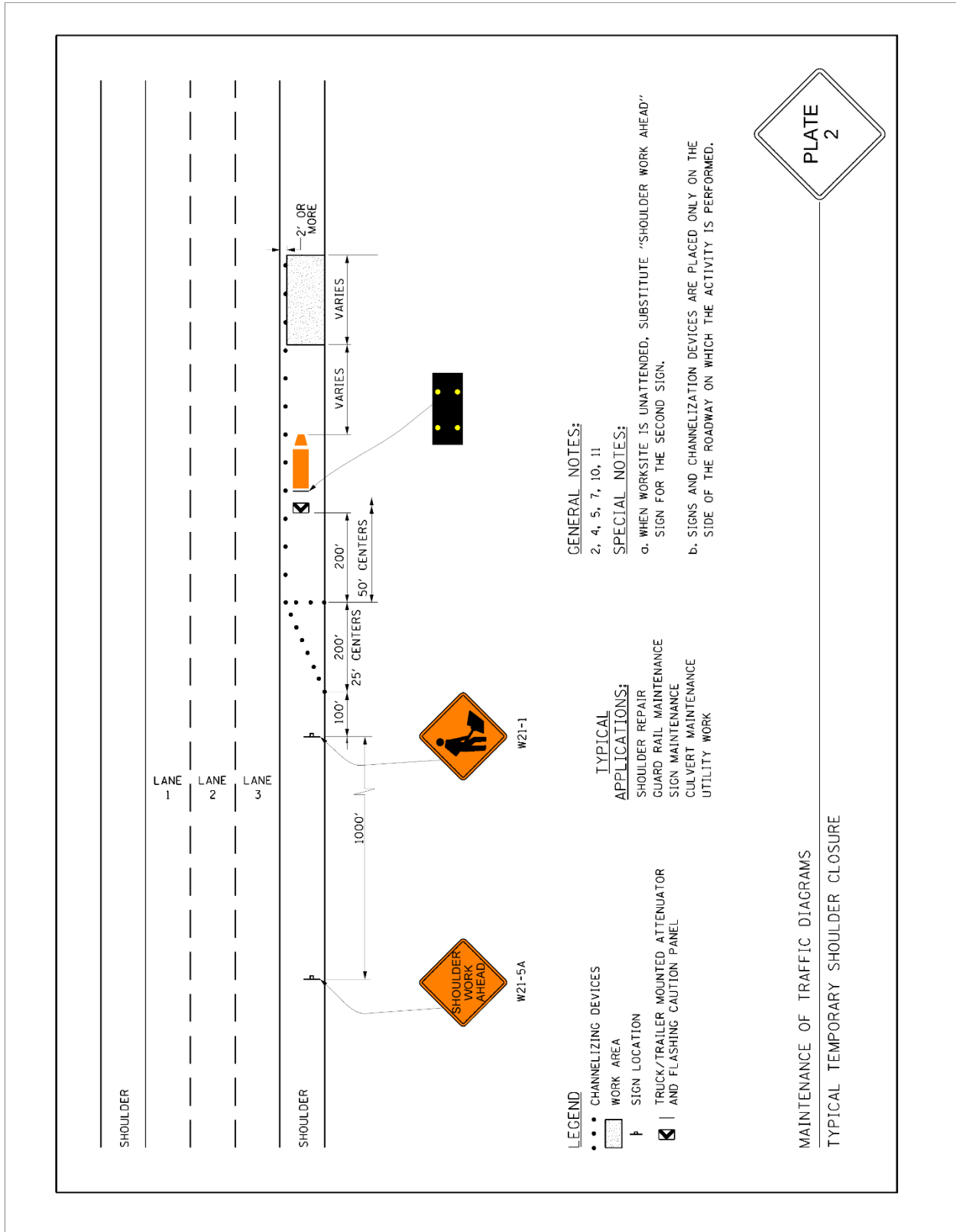

15.2.3 PLATE 3R - TYPICAL TEMPORARY RIGHT LANE CLOSURE

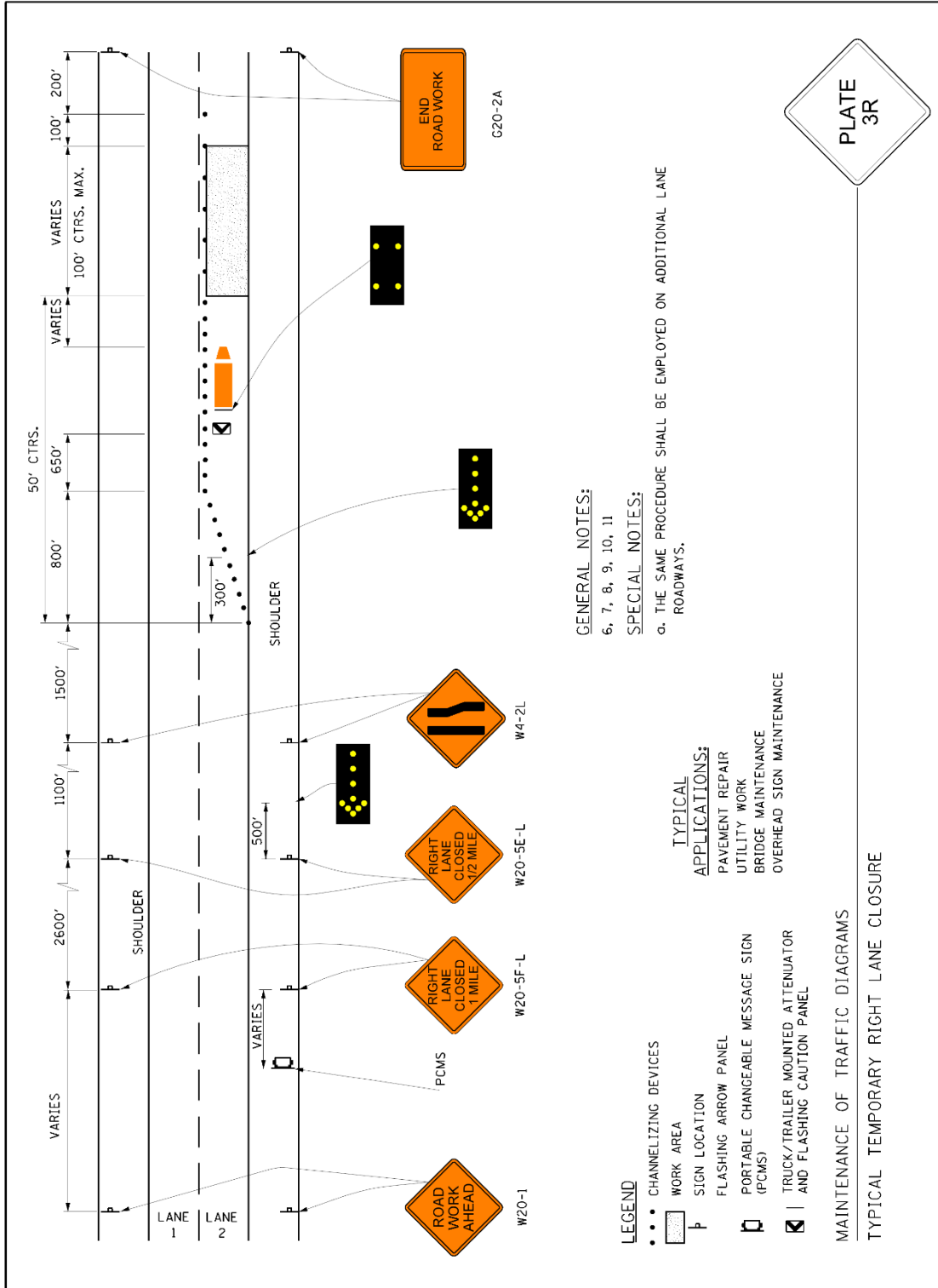

GENERAL NOTES:

6, 7, 8, 9, 10, 11

SPECIAL NOTES:

a. THE SAME PROCEDURE SHALL BE EMPLOYED ON ADDITIONAL LANE ROADWAYS.

LEGEND

- CHANNELIZING DEVICES
- ▭ WORK AREA
- ┆ SIGN LOCATION
- ▭ FLASHING ARROW PANEL
- ▭ PORTABLE CHANGEABLE MESSAGE SIGN (PCMS)
- ▣ TRUCK/TRAILER MOUNTED ATTENUATOR AND FLASHING CAUTION PANEL

TYPICAL APPLICATIONS:

- PAVEMENT REPAIR
- UTILITY WORK
- BRIDGE MAINTENANCE
- OVERHEAD SIGN MAINTENANCE

MAINTENANCE OF TRAFFIC DIAGRAM

TYPICAL TEMPORARY RIGHT LANE CLOSURE



15.2.4 PLATE 3L - TYPICAL TEMPORARY LEFT LANE CLOSURE

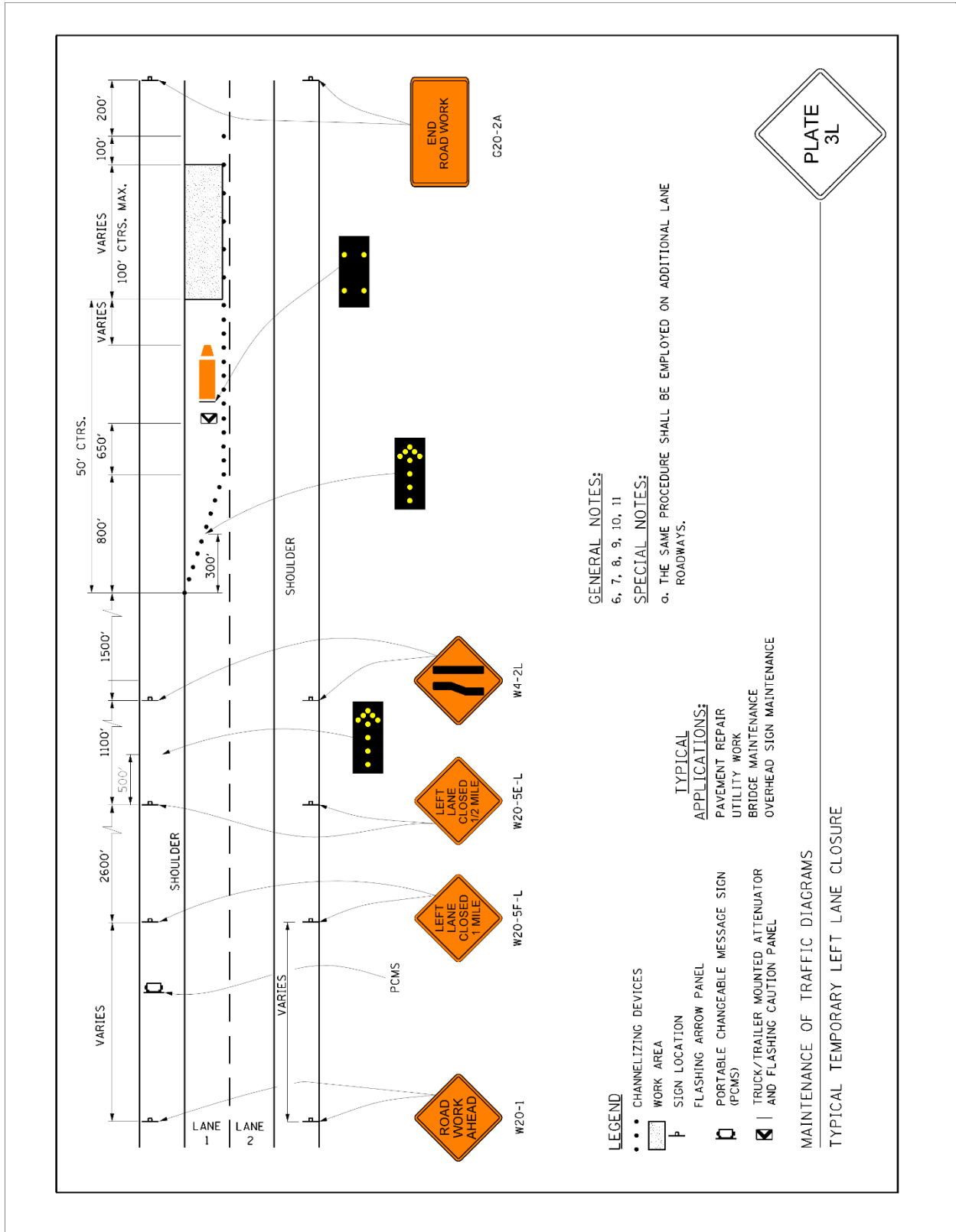

15.2.5 PLATE 4R - TYPICAL TEMPORARY TWO RIGHT LANES CLOSURE

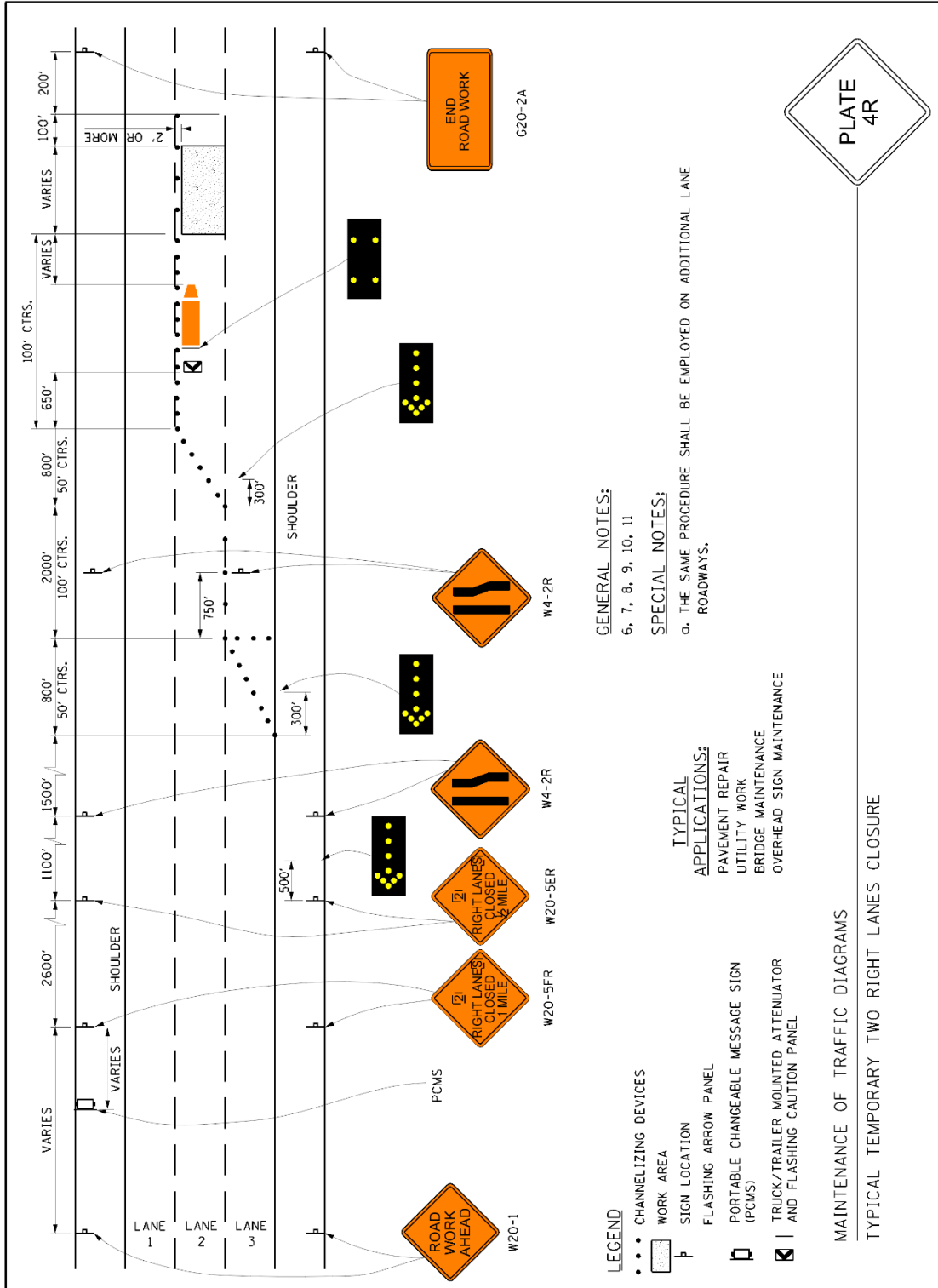

15.2.6 PLATE 4L - TYPICAL TEMPORARY TWO LEFT LANES CLOSURE

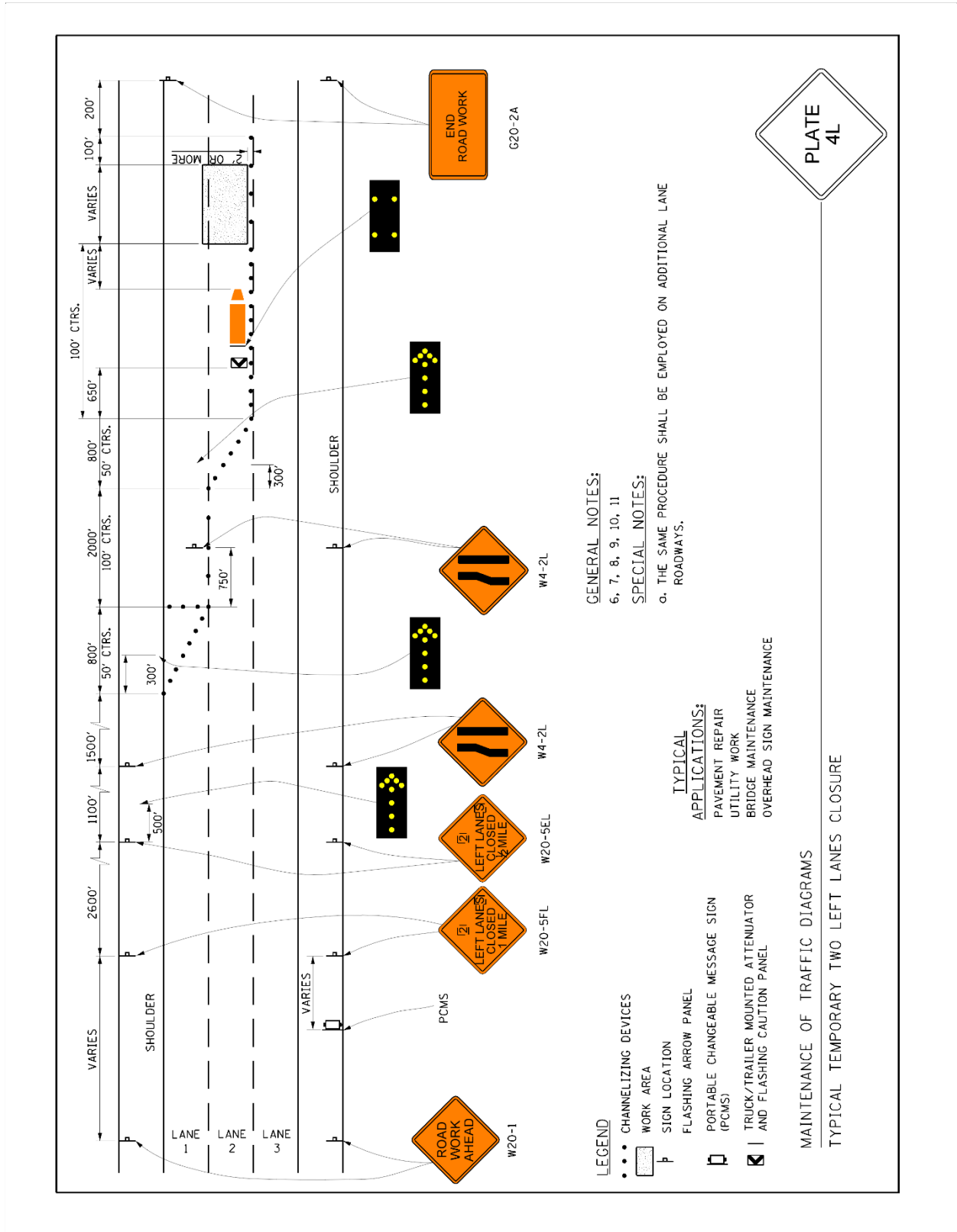

15.2.7 PLATE 5 - TYPICAL TEMPORARY WORK ON ACCELERATION LANE

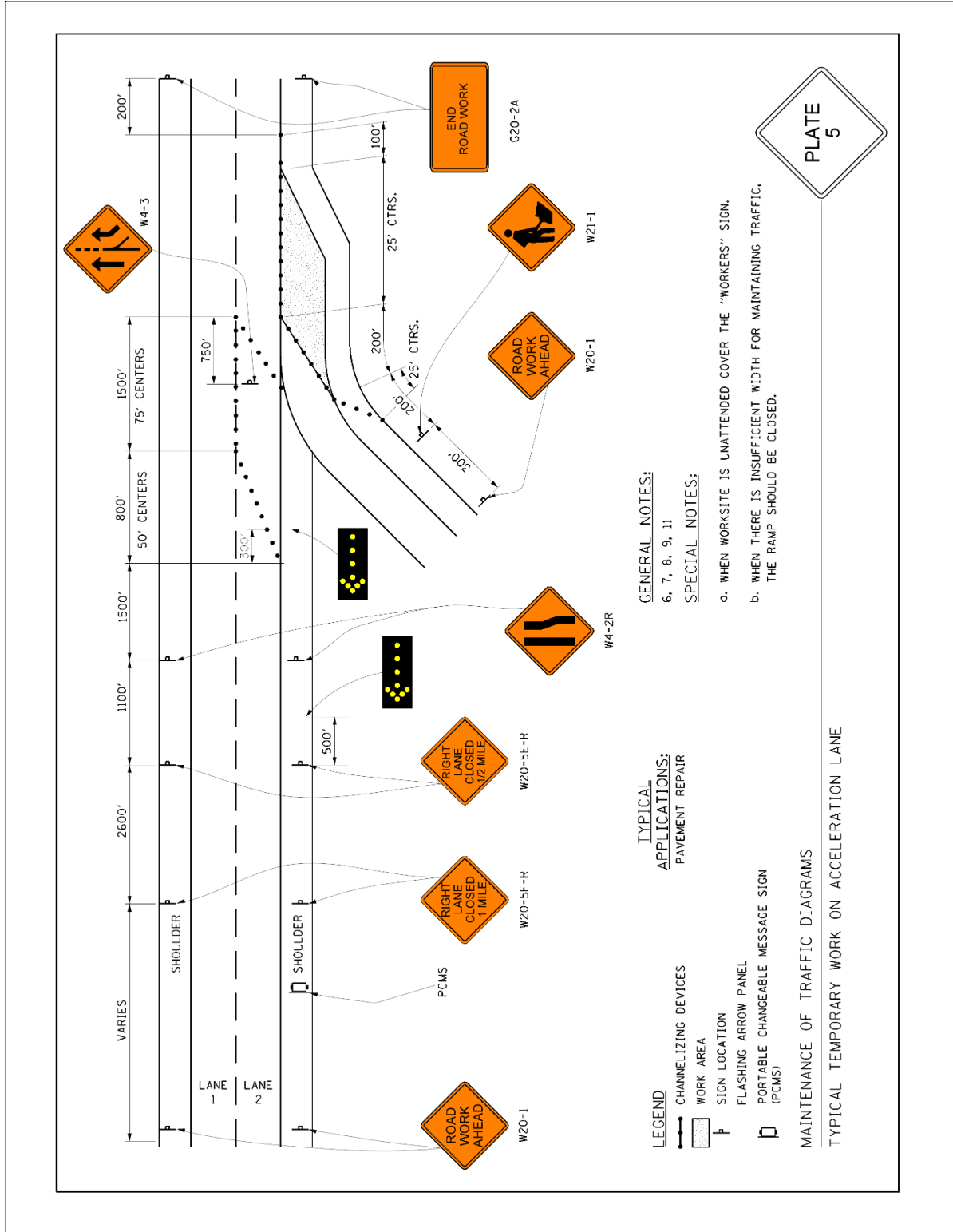

GENERAL NOTES:
6, 7, 8, 9, 11
SPECIAL NOTES:
a. WHEN WORKSITE IS UNATTENDED COVER THE "WORKERS" SIGN.
b. WHEN THERE IS INSUFFICIENT WIDTH FOR MAINTAINING TRAFFIC, THE RAMP SHOULD BE CLOSED.

TYPICAL APPLICATIONS:
PAVEMENT REPAIR

LEGEND
CHANNELIZING DEVICES
WORK AREA
SIGN LOCATION
FLASHING ARROW PANEL
PORTABLE CHANGEABLE MESSAGE SIGN (PCMS)

MAINTENANCE OF TRAFFIC DIAGRAM
TYPICAL TEMPORARY WORK ON ACCELERATION LANE



15.2.8 PLATE 6 - TYPICAL DECELERATION LANE AND/OR RAMP LANE CLOSURE

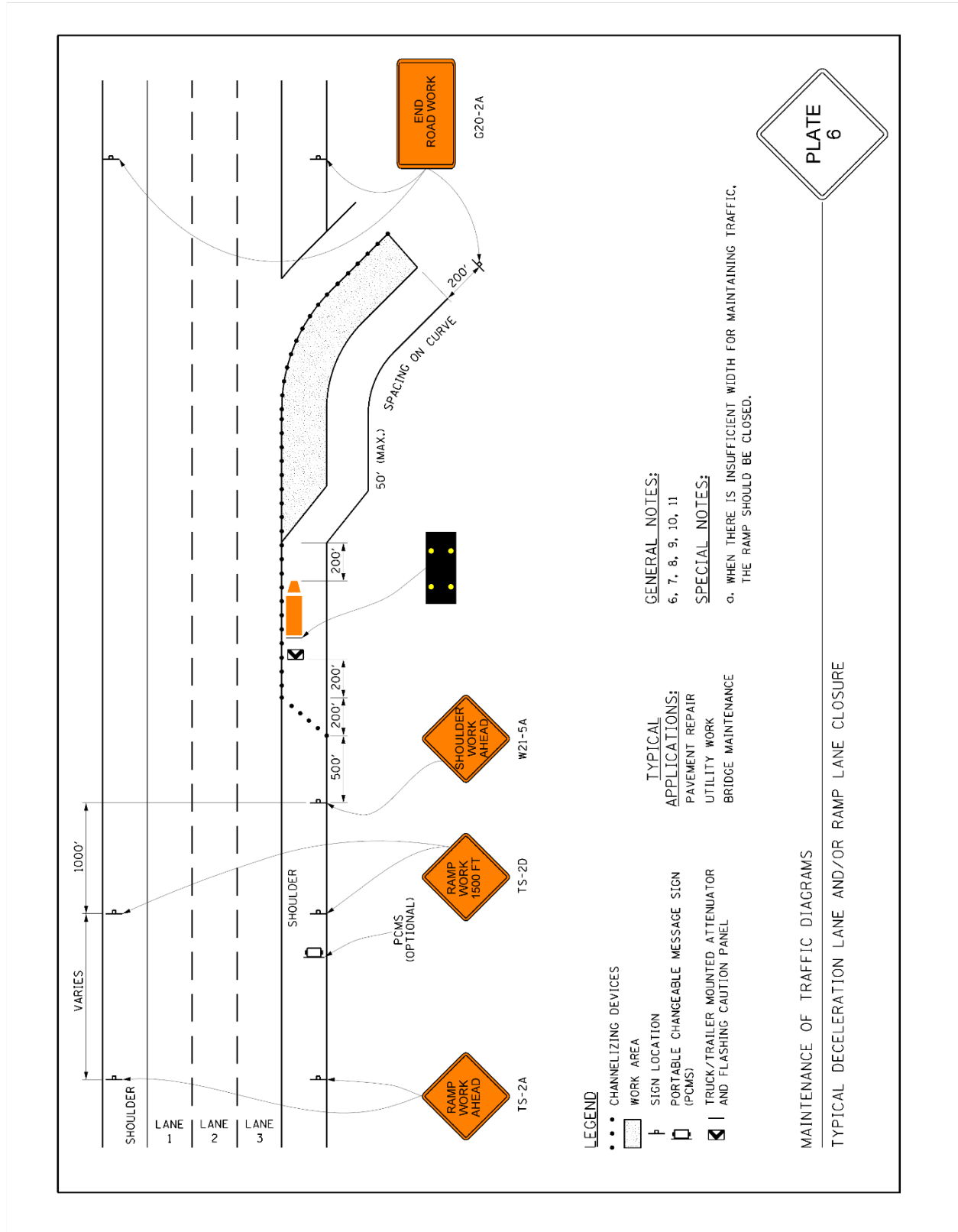

15.2.9 PLATE 6A - TYPICAL DECELERATION LANE CLOSURE

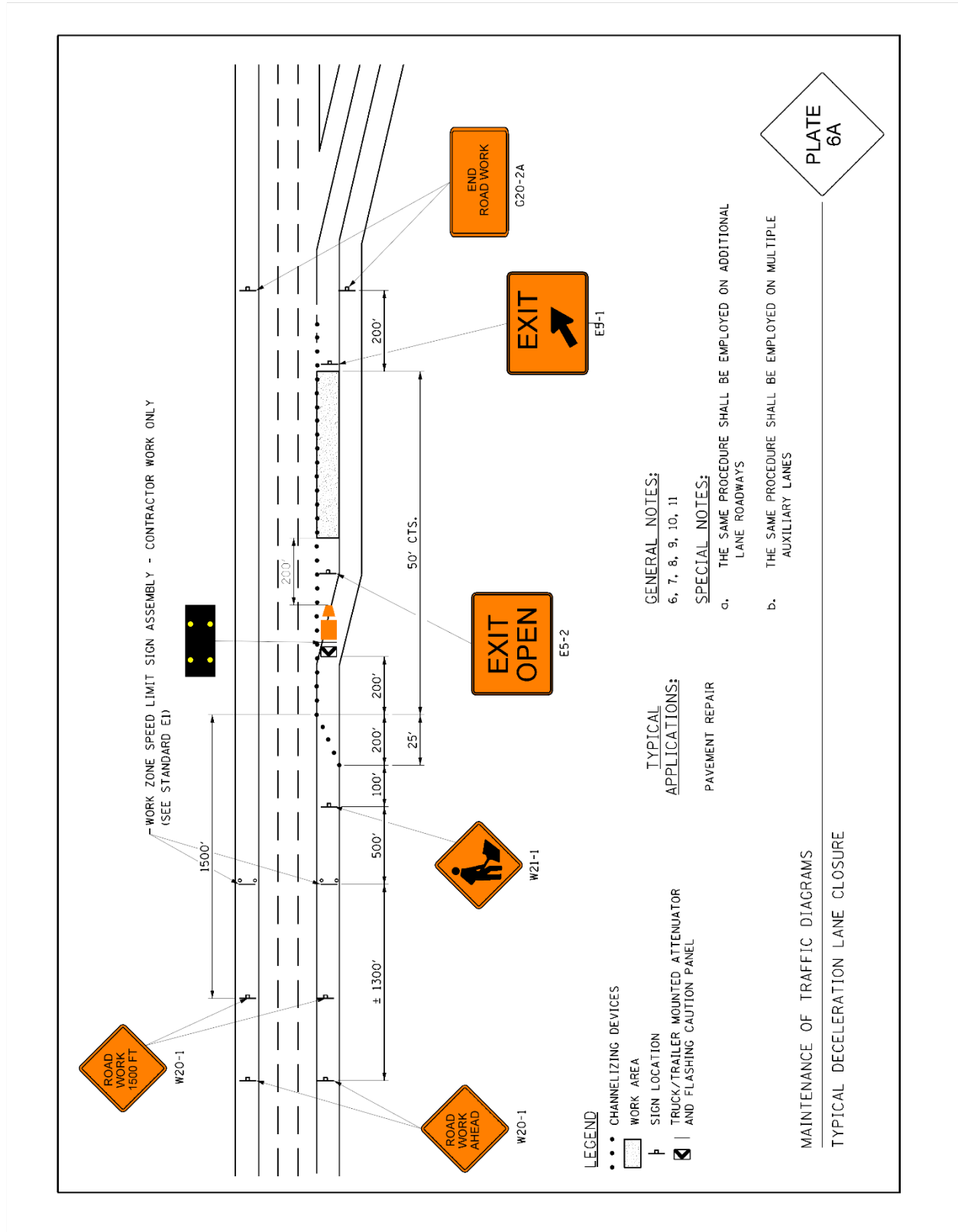

15.2.10 PLATE 7 - TYPICAL WORK IN TOLL PLAZA

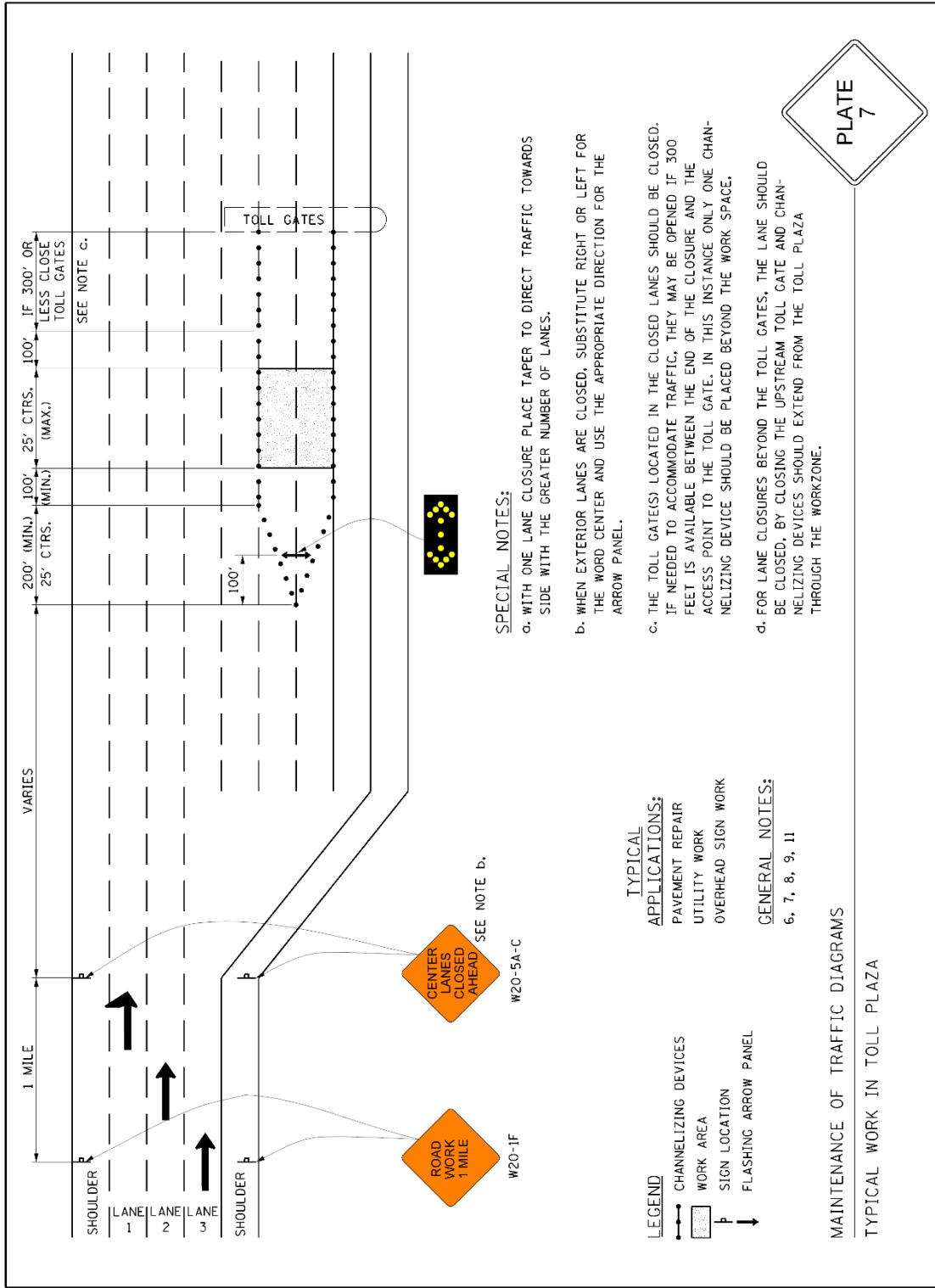

15.2.11 PLATE 8 - TYPICAL MOBILE OPERATION ON SHOULDER

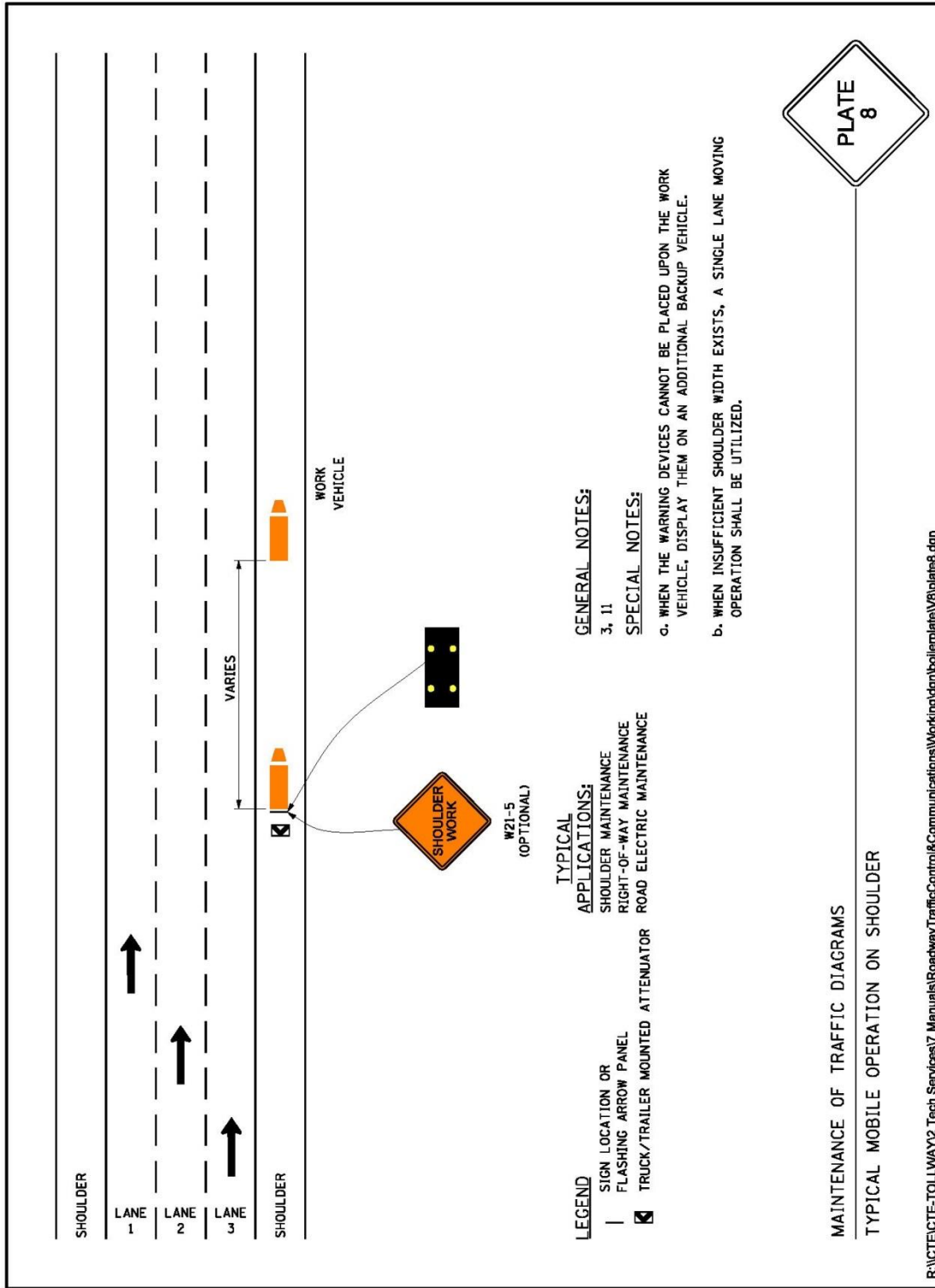

15.2.12 PLATE 9R - TYPICAL MOBILE OPERATION-SINGLE RIGHT LANE CLOSURE

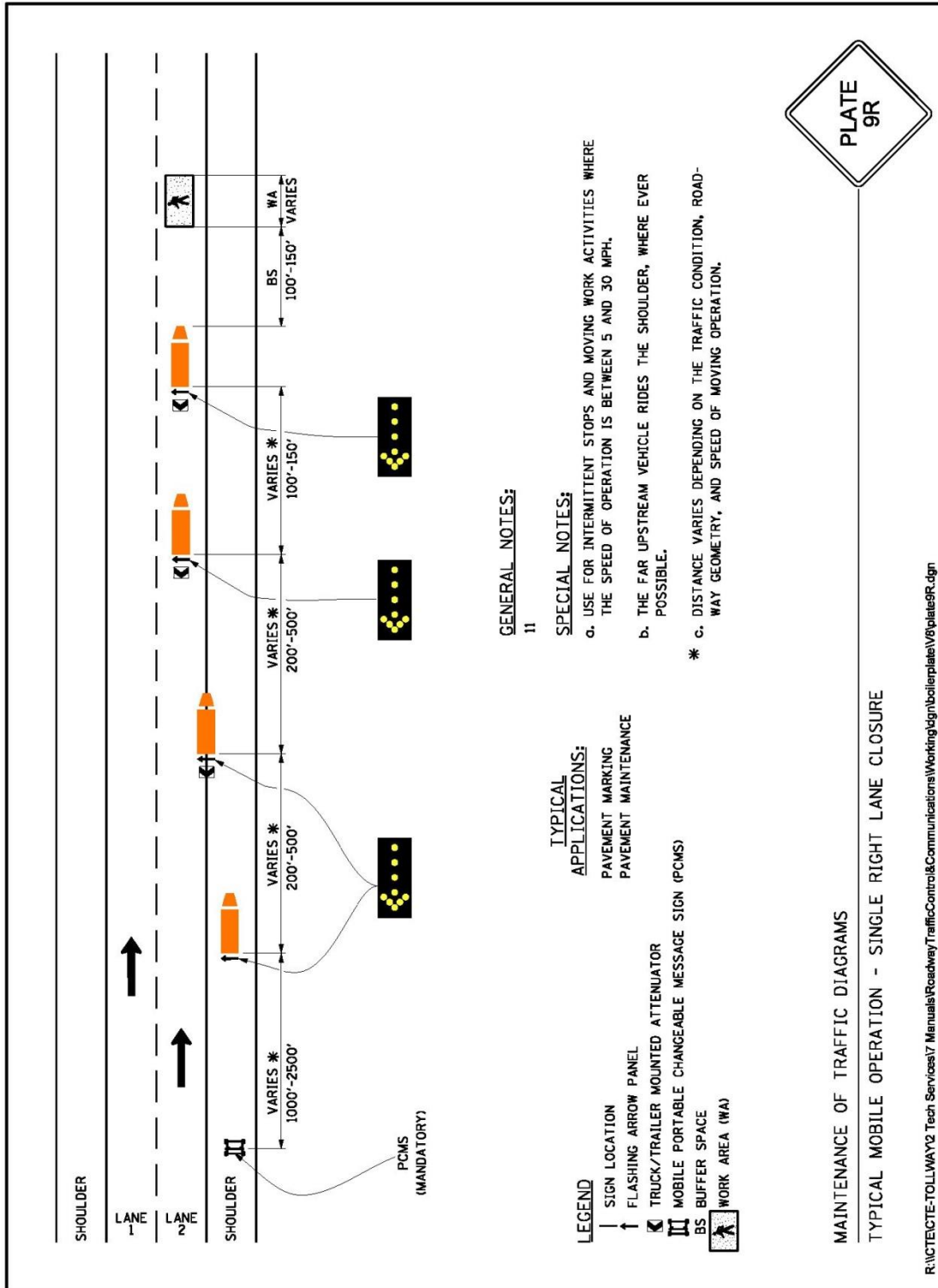

15.2.13 PLATE 9L - TYPICAL MOBILE OPERATION-SINGLE LEFT LANE CLOSURE

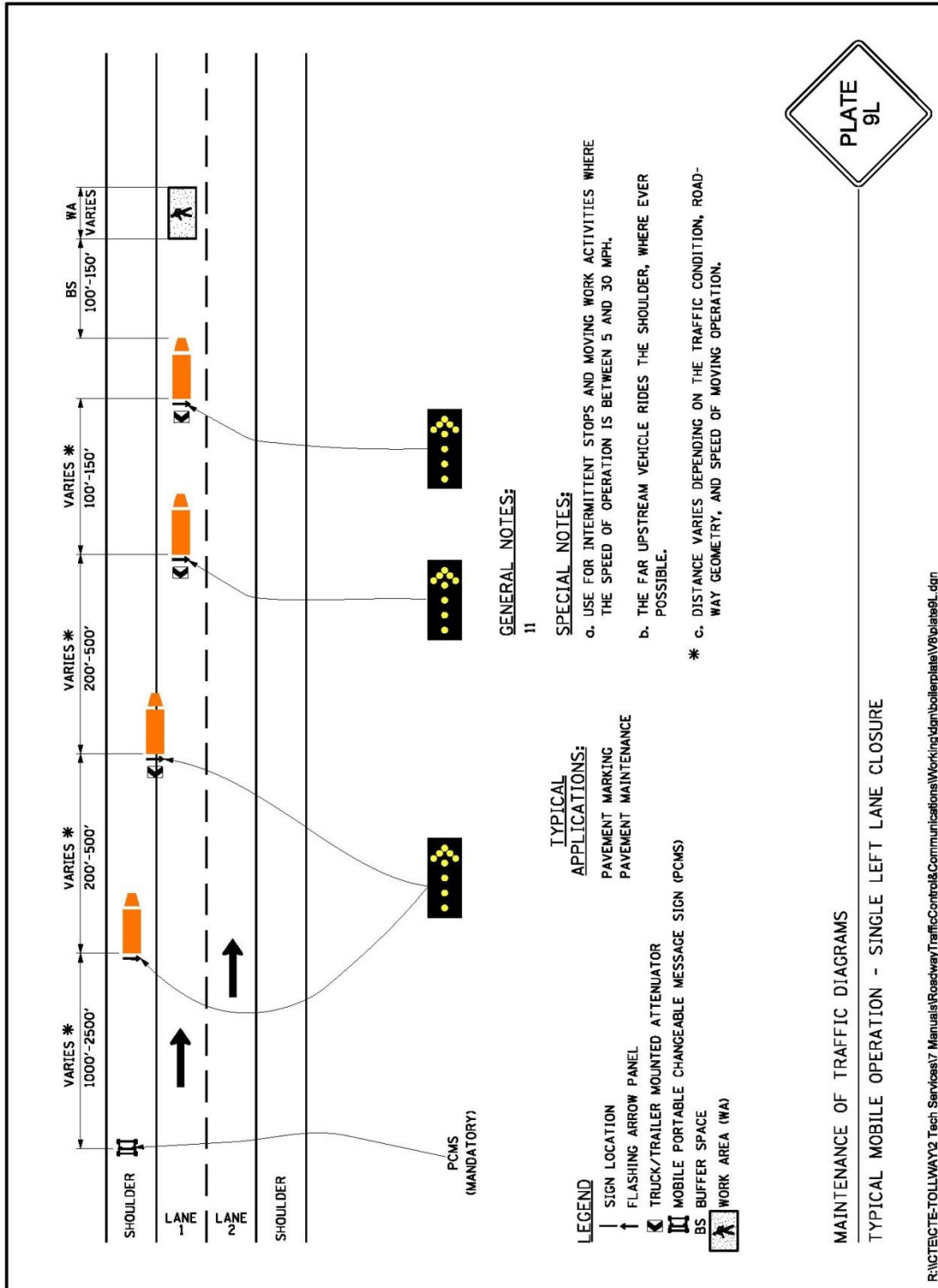

15.2.15 PLATE 10L - TYPICAL MOBILE OPERATION-TWO LEFT LANES CLOSURE

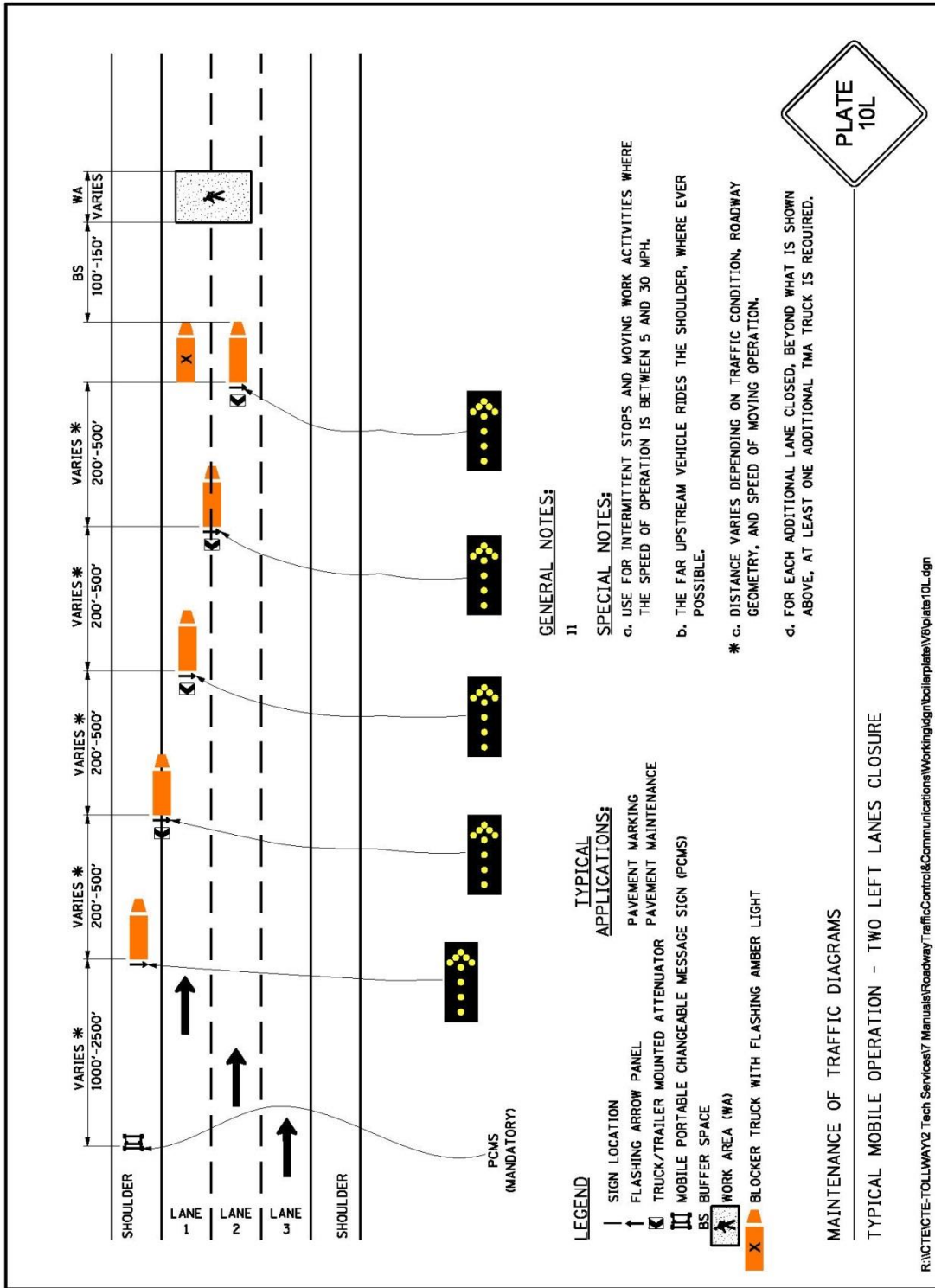

15.2.16 PLATE 11R - TYPICAL RIGHT LANE CLOSURE-EMERGENCY SITUATION

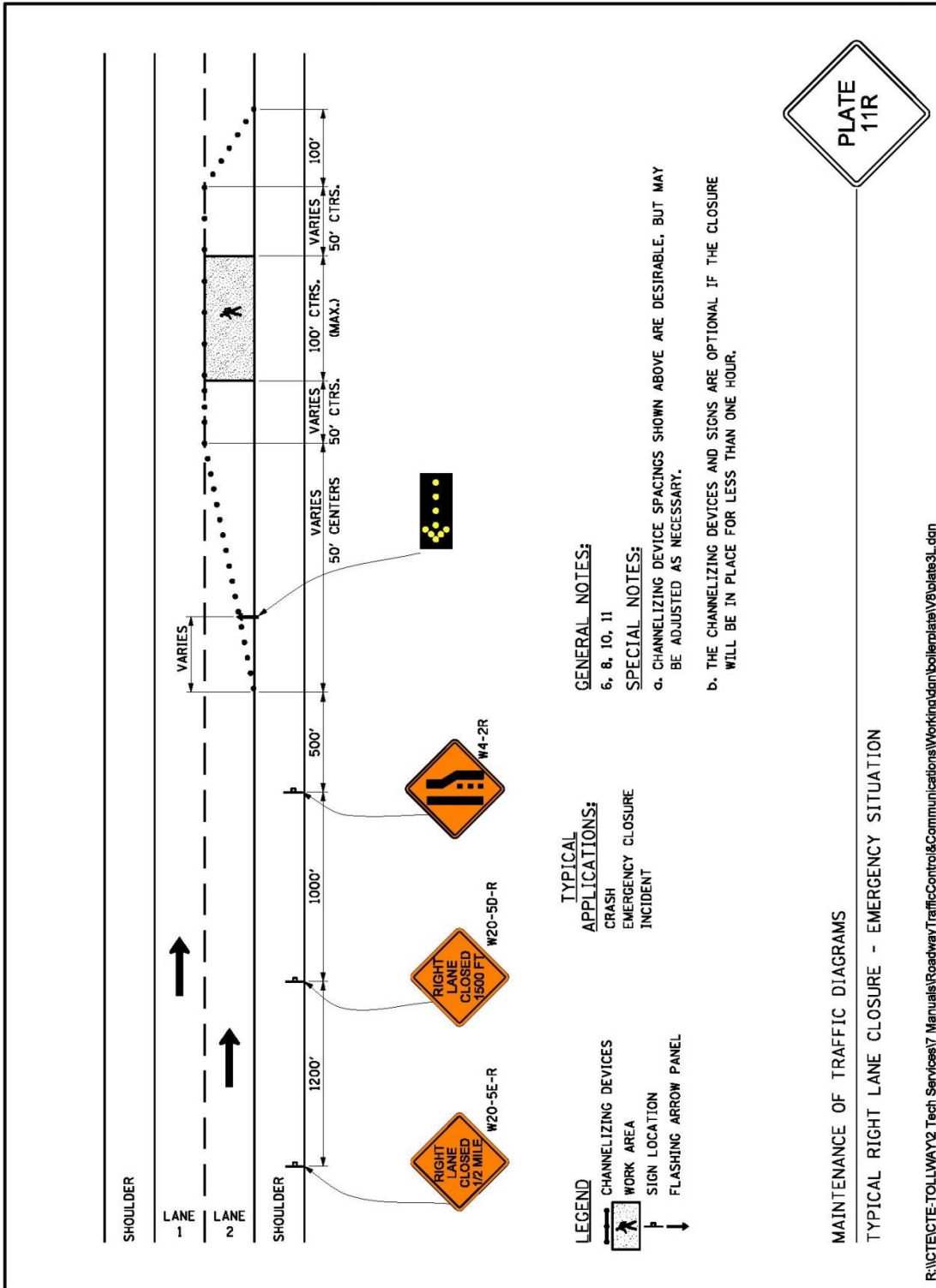

15.2.18 PLATE 12R - TYPICAL TWO RIGHT LANES CLOSURE-EMERGENCY SITUATION

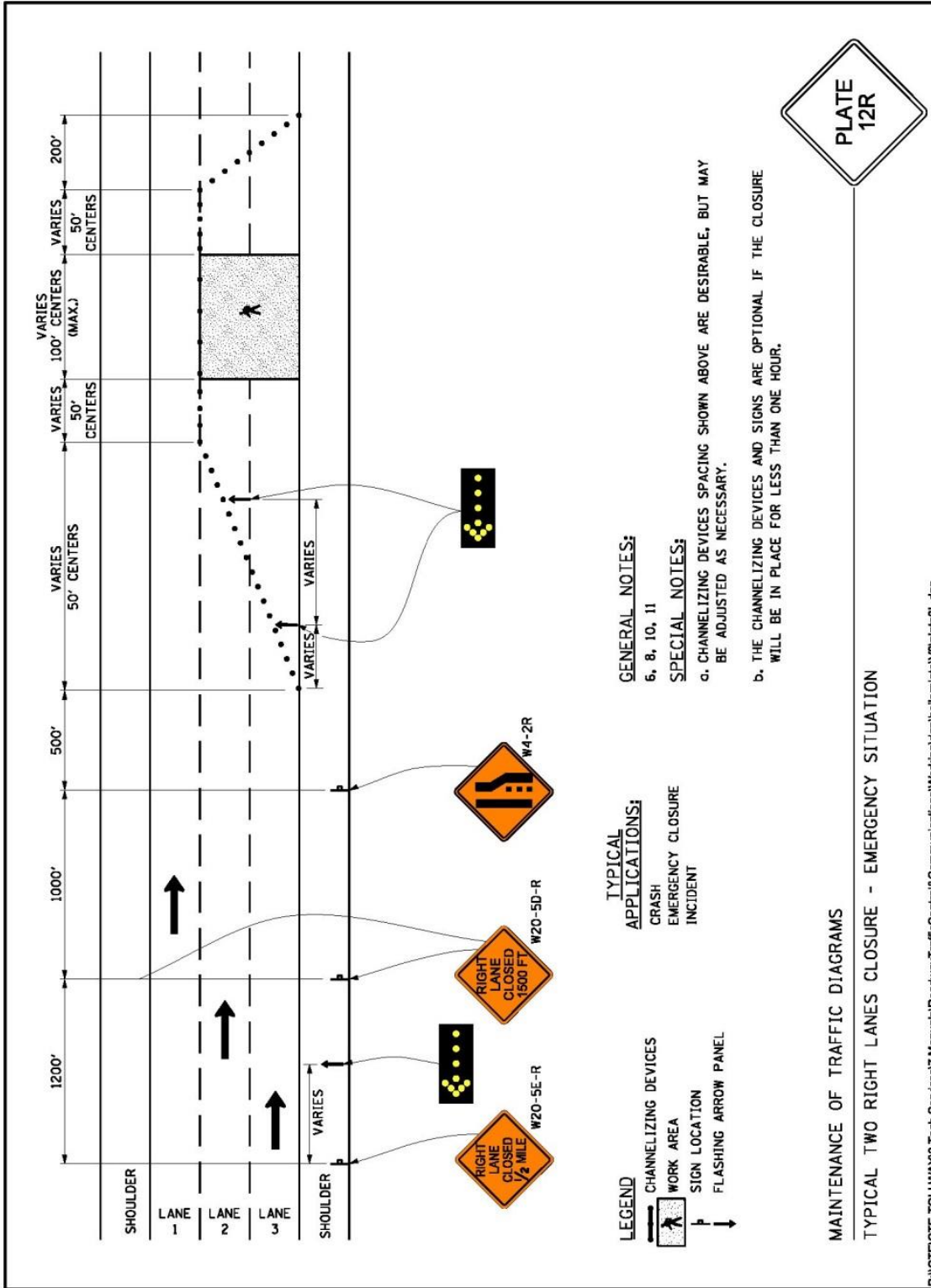

R:\ICT\CTE-TOLLWAY\2 Tech Services\7 Manuals\RoadwayTrafficControl&Communications\Working\signboilerplate\18\plate12L.dgn

15.2.19 PLATE 12L - TYPICAL TWO LEFT LANES CLOSURE-EMERGENCY SITUATION

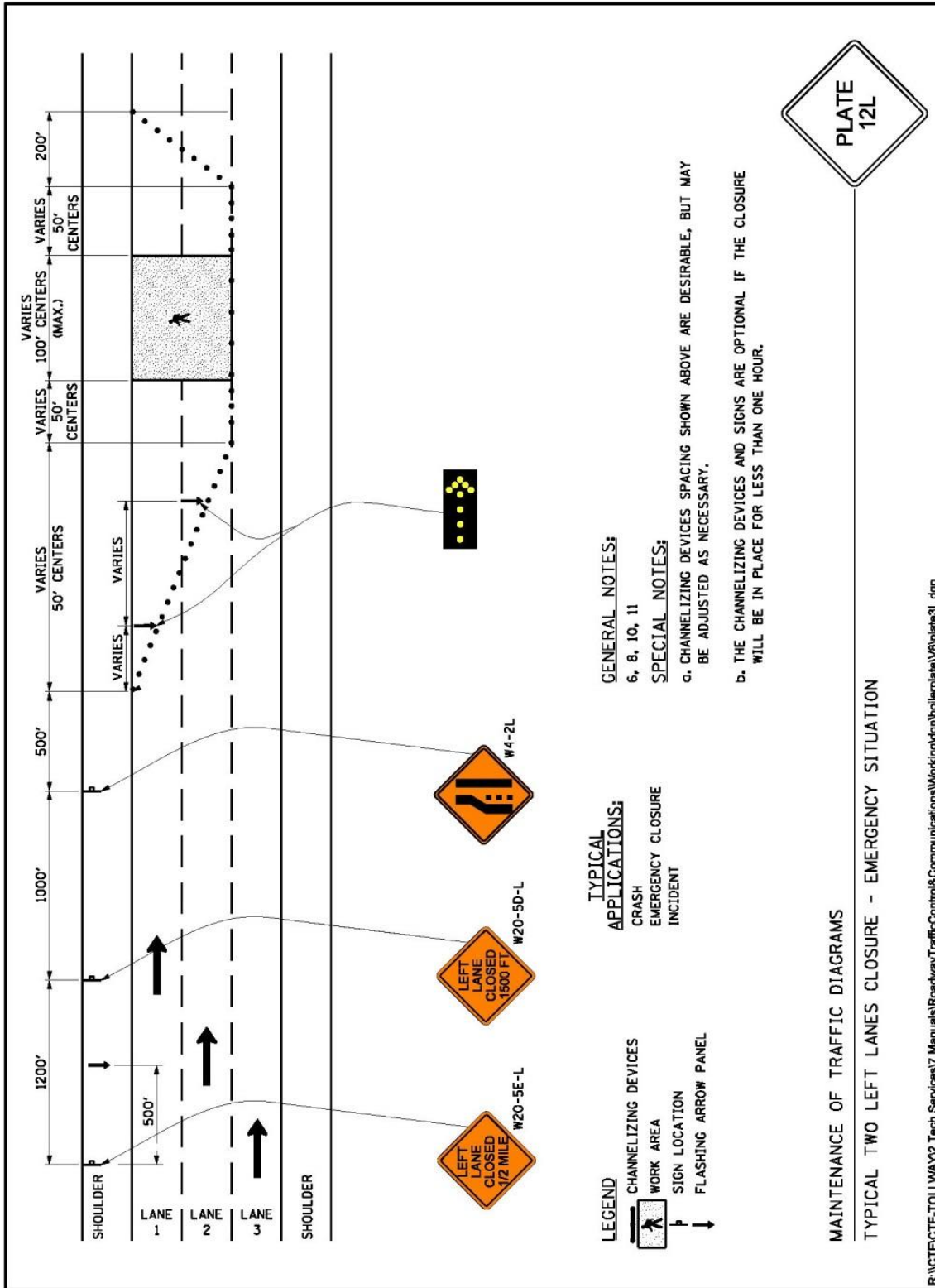

15.2.20 PLATE 13 - PLAZA MAINTENANCE FULL ORT CLOSURE-TWO LANES

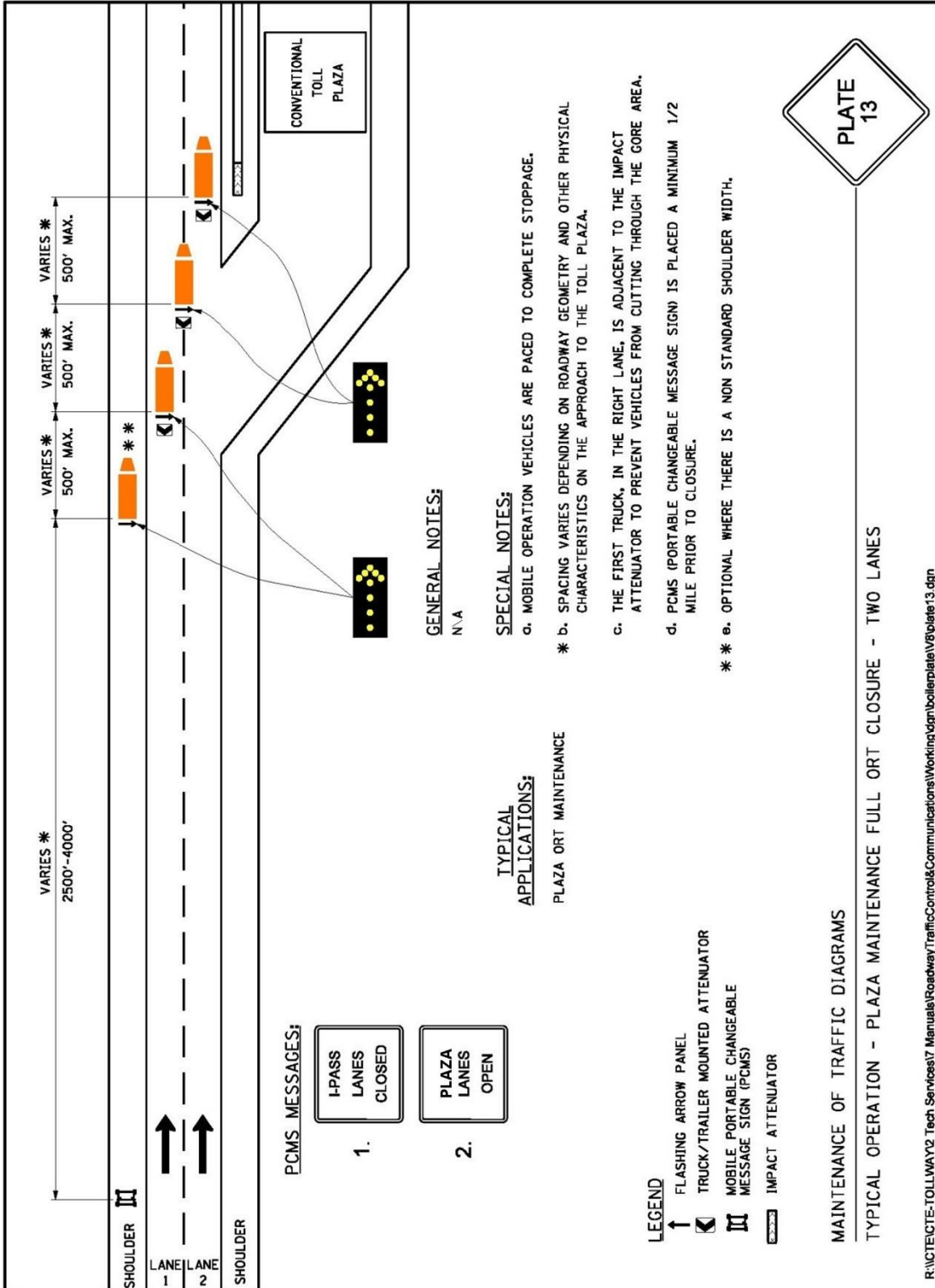

15.2.21 PLATE 14 - PLAZA MAINTENANCE FULL ORT CLOSURE-THREE LANES

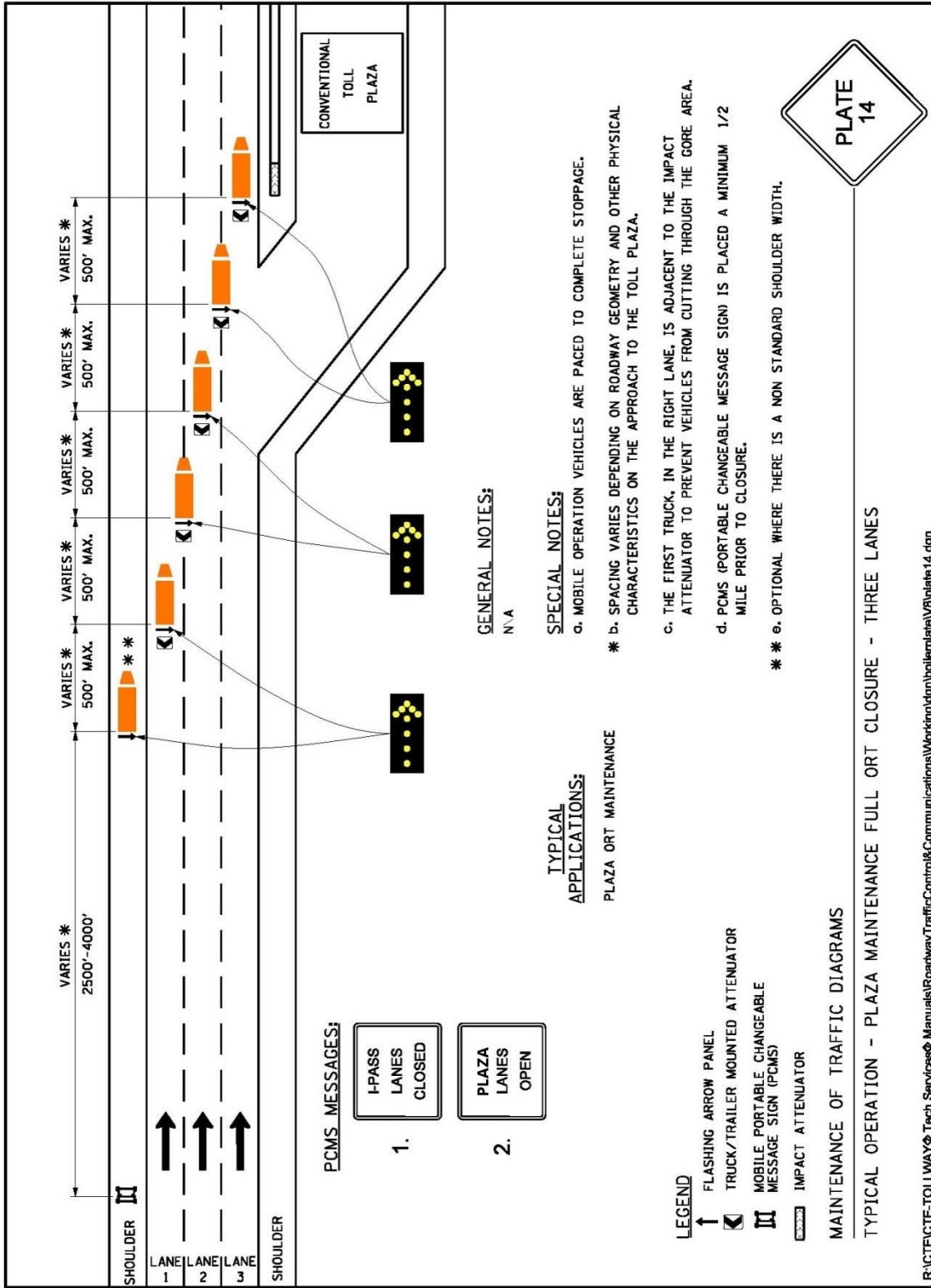

15.2.22 PLATE 15 - PLAZA MAINTENANCE FULL ORT CLOSURE-FOUR LANE

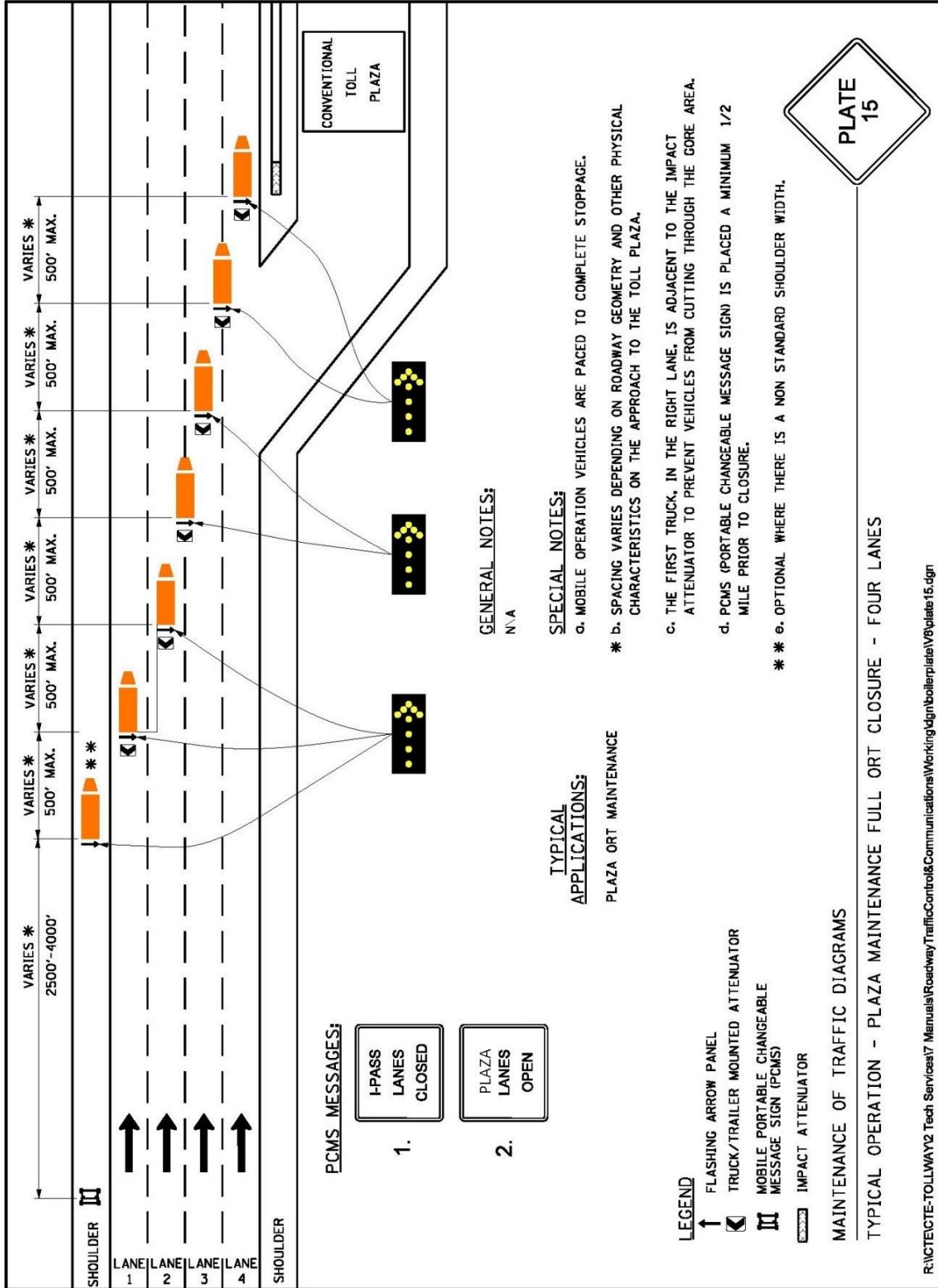

APPENDIX A – CONSTRUCTION COMMUNICATION ROLES AND RESPONSIBILITIES

Providing a high level of safety for the Illinois Tollway is enhanced by providing information about maintenance and construction activities to the traveling public in a timely manner. The Illinois Tollway's Communication and Marketing Department (hereinafter referred to as 'Communications'), uses various means for these public communications, including press releases, emailed construction alerts, fact sheets, dynamic message signs (DMS), Construction Communications Initiatives signs, etc. Communications also works to ensure that the content of signage is clear and consistent with other messages being delivered to Illinois Tollway users.

To facilitate the link between Communications and Construction Managers (CM), a PCL will be established. In most cases, the PCL will have already been established for an Illinois Tollway corridor or group of Illinois Tollway projects. In some cases, the PCL will be an employee of the CM. It is the responsibility of the PCL to fully understand the scope and schedule of work to be performed on the Illinois Tollway, and to transmit that information to the Illinois Tollway's Communications Department. A Construction Communication Coordinator (CCC) at the Illinois Tollway is then responsible for developing various communications to inform the traveling public and news media.

CM's will be informed at or before notice to proceed of whether a PCL exists, who that person is, and how to contact them. If a PCL has not been identified, the Illinois Tollway Project Manager or a CM employee will be designated to fulfill PCL responsibilities.

The PCL should review lane closure requests with the CM before they are submitted, so the PCL should be aware of all requests, but the CM should also copy the PCL on all lane closure requests to verify when the forms are submitted.

Cancellations or changes of planned lane closures should be in accordance with Illinois Tollway-Lane Closure Reference Guide.

APPENDIX B – TRAFFIC FORMS

Traffic forms and guides are available on the WBPM System:

Location: e-Builder

Project: 0016 WBPMS e-Builder Program Wide

Folder: Documents\Templates and Forms

Sub Folder: Traffic-MOT

APPENDIX C – PROCEDURES FOR PLACING TRAFFIC CONTROL SIGNAGE

The following are guidelines that Contractors, Maintenance, Utility Companies, Design Section Engineers and Construction Managers may use for the placement of Traffic Control devices when needed along the Illinois Tollway system.

In case of discrepancy between the contract document and this MOT MANUAL, the Contractor shall follow the contract document.

The dimensions provided may be adjusted to avoid conflicts in the field. The noted devices shall apply for all contracts with the Illinois Tollway – measures used by Illinois Tollway Maintenance may be modified as necessary.

Shoulder Closure

A shoulder closure is required whenever activities are required on the paved shoulder or within 2 feet from the edge of shoulder. Whenever practical, the median and the outside shoulder should not be closed at a given location at the same time. See Plate 2 for details.

Provided the widths of the traveled lanes are not reduced, the speed limit through the limits of the shoulder closure shall be 55 mph or the posted speed limit whichever is less. Short duration and maintenance closures do not require speed reduction.

400 feet in advance of the work zone a 200 foot taper shall be placed from the edge of shoulder to two feet outside of the traveled pavement. The devices shall be either Type II barricades, vertical barricades or drums. When the closure is to be placed during the day and removed the same day, cones may be used in lieu of barricades.

Advance Signage

Prior to all permanent lane closures and lane shifts, the Contractor shall place a series of three (3) traffic control devices to give sufficient advance notice to motorists of the impending construction and the revised lane configuration. These signs shall be stationary (except as noted herein), and will remain throughout the duration of the contract. These signs shall be placed from three to five (3 to 5) miles in advance of the work area – the exact location will be either shown on the plans or will be as directed by the CM. The following factors will influence the location of these signs:

- Is the location an urban or rural Illinois Tollway?
- Number of Lanes in each direction
- Posted speed limit
- Interchange within the 3 to 5 miles of the work area. It is desirable to place the advance signing prior to the interchange, to allow motorists the opportunity to use an alternate route.
- Duration of the closure. Closures and/or shifts that are short term may require less advance notice.

Care must be taken to avoid conflicts between project information signage and construction signage.

Single Lane Closure

Whenever work is required in either the inside or outside lane of mainline pavement, or on the shoulder and within two feet of the EOP, a single lane closure shall be set and properly maintained. See Plate 3R and 3L for details.

When the expected duration of the lane closure will exceed four days or as specified in the contract documents, existing pavement markings which conflict in message with the traffic control will be removed in accordance with Section 703 of the Standard Specifications. The reflectors for existing raised pavement lane markers, within the limits of the conflicting pavement markings, shall also be removed. Additionally, Temporary Pavement Marking (either paint or tape, per Section 703 of the Standard Specifications) will be applied beginning 100 feet prior to the beginning of the taper to the end of the buffer space. The temporary pavement markings may be extended through the work area, should the work area be of limited length or of an extended duration, as determined by the CM.

Direction Indicator Barricades shall exclusively be used for all closure tapers, with the barricades spaced 50 feet on center and the arrows pointing in the direction of the open lane(s).

The requirements for traffic control within the limits of the work area are presented in Article 5, Work Zone Area.

Two-Lane Closure

For two-lane closure see Plate 4R and 4L for details.

When the existing cross-section consists of three or more lanes, and it is necessary to close a center lane, then all lanes between the center lane and the nearest shoulder shall be closed.

Work Zone Area

Type II barricades, vertical barricades, or drums shall be used tangent to the work areas established by lane closures or lane shifts. Lane closures of a short duration or for Maintenance operations may use cones in lieu of barricades tangent to the buffer space and work zone areas.

Whenever a permanent lane closure and /or lane shift is required, the speed limit for the open lanes shall be established in accordance with Article 5.3.2.

Check barricades (Type II or Type III) shall be placed in the closed lane and/or shoulder at 1000 feet intervals to discourage motorists from driving in the work area. Check barricades may be omitted if patching barricades are required.

Lane Shifts

The Illinois Tollway recommends the use of lane shifts when the anticipated duration of work as well as the traffic volume along a section of the Illinois Tollway system would cause backups on a regular basis, and there is sufficient shoulder width opposite the work area, so the shoulder can be used as a lane of traffic on an interim basis.

The traffic control measures for a lane shift are dependent upon the roadway geometry, the locations of interchange ramps or grade separation structures within or near the limits of the lane

shift. The details for this work should be developed as part of the Contract Plan preparation and be reviewed by the Illinois Tollway prior to construction.

APPENDIX D – WORK ZONE SAFETY INSPECTION CHECKLIST

Work Zone Safety Inspection Checklist

Basic Requirements

All traffic control devices should:

- Fulfill a need;
- Command attention;
- Convey a clear, simple message;
- Command respect from road users; and
- Give adequate time for proper response.

The work zone is easy to navigate in a safe manner for someone unfamiliar with the roadway and with some typically reduced visual, mental, and physical capabilities.

- Roadway changes that will require rapid maneuvers, such as lane narrowing, dropped lanes, changes in geometrics, etc., are avoided where possible.
- Temporary traffic control devices are used with the assumption in mind that drivers will only reduce their speeds if they see a need to.

If temporary work zone requires regulatory measures that differ from existing devices (e.g., Speed Limits), existing devices have to be either covered or removed.

Conventional Signing

Sign Visibility

- Appropriate sign sheeting designated by project documents.
- Signs are clean, legible and are positioned properly.
- Retroreflective material used displays approximately the same color in day or night conditions.
- All signs meet the acceptable category in the Illinois Tollway Quality Standards for Work Zone Traffic Control Devices guide.

Appropriate signing for all activities/hazardous conditions

- Signs are spaced so that drivers are able to read each sign and take appropriate actions.
- Lane closures are properly marked.
- Where there are drop-offs and the adjacent lane remains opened to traffic, appropriate sign(s) are in place (UNEVEN LANES and SHOULDER DROP-OFF.)

Proper placement and installation of signs

- Signs should be on the right side of the road unless otherwise stated in MUTCD or contract (Where there are two or more travel lanes in the same direction, as is normally the case on the Illinois Tollway, the sign message should be repeated on the left side of the roadway).
- Sign Height
 - Post-mounted signs shall be placed with the bottom a minimum of 7 feet above the roadway.

- Lateral Offset
 - Edges of signs are a minimum of 2 feet away from adjacent lane.
 - For long-term projects, a distance of 8 to 12 feet is desirable.
- Signs smaller than 36" x 36" may be mounted on a single 4" x 6" wooden post. Signs larger than 36" x 36" or with a width greater than 36 inches must have two wooden posts.
- Sign sizes are as designated by project documents.
- Temporary sign stands are ballasted safely (ballast is not suspended off ground).
- Signs with wooden posts have been drilled for proper breakaway performance.

Electronic Signage

Portable Changeable Message Systems (PCMS)

- The front face of the PCMS sign should be covered with a protective material. The color of the elements should be yellow or orange on a black background.
- The PCMS should be visible from 3000 feet under both day and night conditions. Each sign character shall be clearly legible from a minimum distance of 600 feet for nighttime conditions and 800 feet for normal daylight conditions. The message should have adjustable display rates, so that the entire message can be read at least twice at the posted speed or the anticipated speed.
- Bottom of the panel is at least 7 feet above the roadway.
- The control system should include a display screen for reviewing messages and be capable of maintaining memory when power is interrupted.
- PCMS will automatically adjust brightness under varying light conditions.
- PCMS is equipped with a power source and a back-up battery to provide continuous operation.
- PCMS is compatible and functional with the Illinois Tollway Traffic Management Center (TIMS) Sign Control Software, if required.

Arrow Boards

- For daytime use, the minimum arrow board size shall be 30" by 60" with 13 lamps.
- For nighttime use the minimum size is 48" by 96" with 15 lamps.
- Arrow Board is visible from 0.5 mile under night and day conditions.
- The light intensity shall be reduced during nighttime use to avoid glare and returned to full intensity for daytime use.
- Bottom of the panel is at least 7 feet above the roadway (6 feet to the bottom of the panel for vehicle-mounted arrow boards).
- Arrow Board is equipped with a power source and a back-up battery.

Delineation Devices

Visibility

- Delineation devices are clean and legible.
- Retroreflective material used displays approximately the same color in day or night conditions.

Proper Use of Channelizing Devices

General

- Temporary delineation devices are ballasted safely (not suspended off the ground.)

- The spacing of channelizing devices should not exceed a distance in feet equal to 1.0 times the speed limit in mph when used for taper channelization, and a distance in feet of 2.0 times the speed limit in mph when used for tangent channelization.
- If warning lights are used, they should be put on the side of the device where the traffic is intended to travel.

Cones

- Cones shall be predominantly orange in color and are made out of a material that can be struck without causing damage to the impacting vehicle.
- Cones are proper height for their use and are retroreflectorized for nighttime use.
- Steps are taken to make sure that the cones will not be blown over or displaced by wind or moving traffic, with ballast kept to minimum needed.

Tubular Markers

- Tubular markers shall be predominantly orange in color and are made out of a material that can be struck without causing damage to the impacting vehicle.
- Tubular Markers are proper height for their use and retroreflectorized for nighttime use.
- Markers are affixed to the pavement with ballast kept to minimum needed. If non-cylindrical tubular markers are used, they are attached to the pavement ensuring that the width facing road users meet the minimum requirements (2 inches).
- Tubular markers are only used when there is a limited space.

Vertical Panels

- Vertical panels have alternating orange and white diagonal strips.
- Diagonal stripes slant downward to the direction where the traffic is intended to travel.
- If panels are used at night, they are retroreflectorized.

Drums

- Drums are a minimum of 36 inches in height and have at least 18 inches in width regardless of orientation.
- Metal drums shall not be used.
- Markings on the drums are horizontal, circumferential, alternating orange and white retroreflective stripes 4 to 6 inches wide.
- Drums have closed tops to prevent construction and other debris from collecting in them.
- Sand or any other type of ballast is not placed on top of the drum.
- Drums are not weighed down with ballast to the extent that would make them hazardous to road users or construction personnel.
- Holes are drilled in the bottom of the drum to drain any water.

Type II or III Barricades

- Diagonal stripes slant downward to the direction where the traffic is intended to travel.
- When a highway is legally closed, but access is still allowed for local road users barricades are not extended completely across the road. And appropriate striping is used:

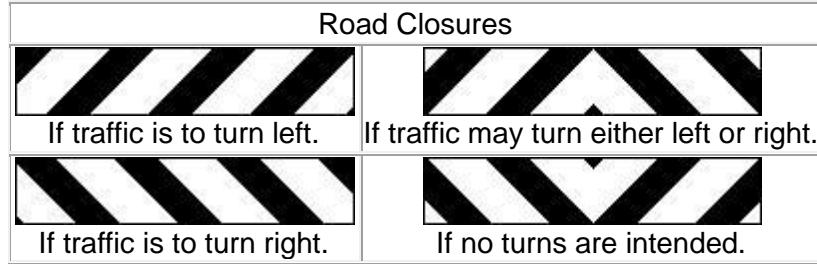

- Stripes are retroreflective.
- Minimum length for type II barricades is 24 inches, minimum for type III is 48 inches, and rails are 8 to 12 inches wide.
- Barricades are supported in a way that allow road users to see them, and in a manner that provides a stable support that is not easily blown over or displaced.
- Ballast is not placed on the upper rails of the barricade and no nondeformable objects such as rocks or chunks of concrete are used as ballast.
- Signs may not be placed on type III barricades but shall be supported on independent supports.

Direction Indicator Barricade

- Consists of a retroreflective horizontal arrow on the top panel and a striped retroreflective bottom panel.
- The arrow board is a black on orange and is 24 inches x 12 inches.
- The striped panel has 4-inch stripes at a 45° angle, pointing down in the direction the arrow points. The panel is 24 inches x 8 inches.

Markings

- Pavement markings match the markings on either end of the project, unless:
 - the road is unsurfaced,
 - it is not possible to provide markings and proper channelizing devices are in place.
 - the contract allows temporary markings, if so:
 - Tape or painted markings for broken lines are at least 2 feet long, every 40 feet
 - All temporary markings are in place no longer than allowed by contract.
- Markings that are no longer applicable are completely obliterated (painting over the markings is not acceptable).
- Surfaced detours or temporary roadways should have normal pavement markings along the entire length.

Flaggers and Spotters

- Flaggers and spotters are certified and have a sense of responsibility, adequate training, average intelligence, are in good physical condition, are mentally alert, courteous but firm and have a neat appearance.

High-visibility clothing

- Vest, shirt or jackets should be orange, yellow, yellow/green or a fluorescent version of these colors that meets the Performance Class 3 requirements of the ANSI/ISEA 107-2004 or

ANSI/ISEA 107-2010 publication entitled "American National Standard for High-Visibility Safety Apparel and Headwear". For night operations, flaggers and spotters shall be equipped with full-body garments meeting these requirements.

Proper devices and procedures

- Flaggers should have SLOW Paddles made out of type III or IV retroreflective material.
- SLOW paddles are a minimum of 18 inch with minimum 6-inch height of letters.
- Flaggers and pilot cars are provided with 2-way radios unless they are within sight of each other.
- If railroad crossing exists, the flagger will not be allowed to create conditions where vehicles can be stopped with no means of escape.
- Flagger Stations are at an appropriate distance from the workers.

Construction Personnel/Equipment

- High-visibility clothing use same standards that are used for flaggers.
- Personal vehicles are parked off the traveled roadway (preferred) or at least outside the clear zone.
- Construction equipment and supplies (including traffic control devices) that are not in use are stored off the traveled roadway and outside the clear zone in accordance with Article 701.06(m) of Illinois Tollway Supplemental Specifications.

APPENDIX E – ILLINOIS DEPARTMENT OF TRANSPORTATION STANDARDS

CONES

DAYTIME USE

Orange
Posted speed < 45 mph

DAY OR NIGHTTIME USE

Orange
Any posted speed

TUBULAR MARKER

VERTICAL PANEL POST MOUNTED

DRUM

TYPE I BARRICADE

TYPE II BARRICADE

TYPE III BARRICADE

DIRECTION INDICATOR BARRICADE

VERTICAL BARRICADE

DETECTABLE PEDESTRIAN CHANNELIZING BARRICADE

* Warning lights (if required)

GENERAL NOTES

All heights shown shall be measured above the pavement surface.
All dimensions are in inches (millimeters) unless otherwise shown.

DATE	REVISIONS
1-1-19	Revised cone usage and added cones >36" (900 mm) height.
1-1-18	Revised END WORK ZONE SPEED LIMIT sign from orange to white background.

TRAFFIC CONTROL DEVICES

STANDARD 701901-08

(Sheet 1 of 3)

Illinois Department of Transportation

APPROVED BY: [Signature] 2019

FOR THE DIRECTOR OF TRANSPORTATION AND INFRASTRUCTURE

APPROVED BY: [Signature] 2019

FOR THE CHIEF ENGINEER

ILLINOIS TOLLWAY

ROAD CONSTRUCTION NEXT X MILES 620-1104(01)-6036

END CONSTRUCTION 620-1105(01)-6024

This signing is required for all projects 2 miles (3200 m) or more in length. ROAD CONSTRUCTION NEXT X MILES sign shall be placed 500' (150 m) in advance of project limits. END CONSTRUCTION sign shall be erected at the end of the job unless another job is within 2 miles (3200 m). Dual sign displays shall be utilized on multi-lane highways.

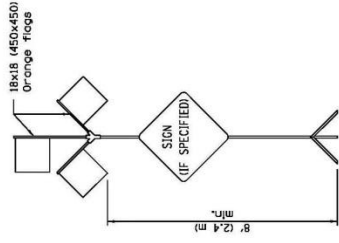

WORK LIMIT SIGNING

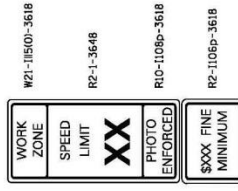

Sign assembly as shown on Standards or as allowed by District Operations. END WORK ZONE SPEED LIMIT 620-1103(01)-6036. This sign shall be used when the above sign assembly is used.

HIGHWAY CONSTRUCTION SPEED ZONE SIGNS

**** R10-108p shall only be used along roadways under the Jurisdiction of the State.

SIGNS ON TEMPORARY SUPPORTS

*** When work operations exceed 24 hours, this sign shall be 5' (1.5 m) min. If located behind other devices, the height shall be sufficient to be seen completely above the devices.

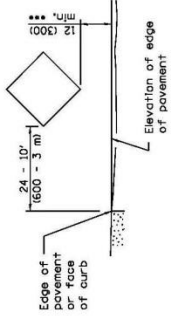

HIGH LEVEL WARNING DEVICE

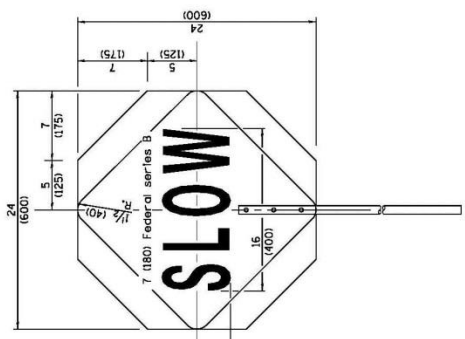

REVERSE SIDE

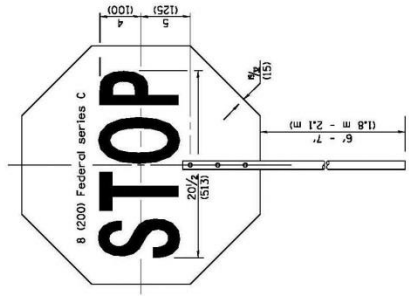

FRONT SIDE

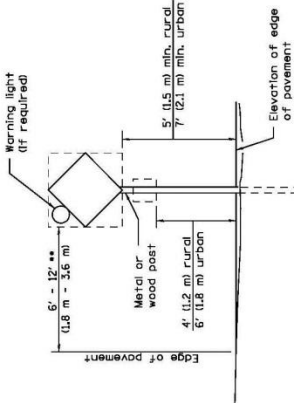

POST MOUNTED SIGNS

** When curb or paved shoulder are present this dimension shall be 24' (600) to the outside edge of the curb or 10' (300) to the outside edge of the paved shoulder.

WIDTH RESTRICTION SIGN

XX'-XX" width and X miles are variable.

FLAGGER TRAFFIC CONTROL SIGN

TRAFFIC CONTROL DEVICES
STANDARD 701901-06
(Sheet 2 of 3)

Illinois Department of Transportation
APPROVED: [Signature] PROJECT NO. 2017
ENGINEER OF OPERATIONS
APPROVED: [Signature] PROJECT NO. 2017
INSPECTOR: [Signature] DESIGN AND CONSTRUCTION
ISSUED 1-1-97

APPENDIX F – FLOW CHARTS FOR CONSIDERATION OF WORK ZONE SPEED LIMITS

Location: e-Builder

Project: 0016 WBPMS e-Builder Program Wide

Folder: Document\Templates and Forms \ Traffic - MOT

Hyperlink's Flow Charts Version 1.4

<https://app.e-builder.net/da2/Documents/FileView.aspx?FileID={8F5CFB3E-1C5D-4F54-9A82-A4D4F4BE6475}&Logged=true>

APPENDIX G – WORK ZONE SPEED LIMIT FORM

Location: e-Builder
Project 0016 WBPM e-Builder Program Wide
Folder: Document\Templates and Forms \ Traffic - MOT

Hyperlink: WZSL Form Version 1.5

<https://app.e-builder.net/da2/Documents/FileView.aspx?FileID={E57A4696-74BA-4DEF-83C3-3BEC7AB39A02}&Logged=true>