

<b>Tollway Standard Drawing Revisions</b>
---

<b>Section E</b>	<b>MOT</b>	
	<b>Standard</b>	<b>Modification Summary</b> <span style="float: right;"><b>Effective 11/1/2012</b></span>
	<b>E1</b>	<b>Construction Signs</b>
	Sheet 1	Deleted Signs TS-1
	<b>E2</b>	<b>Lane Closure Details</b>
	Sheet 3	Added three lane closure details.
	<b>E4</b>	<b>MOT-Reverse Curve</b>
		Revised Note 4
	<b>E7</b>	<b>Emergency Pull-out Area</b>
		Revised length of pull-out area to accommodate standard TCB lengths.
		Revised Note 1

	New Sheet
--	-----------

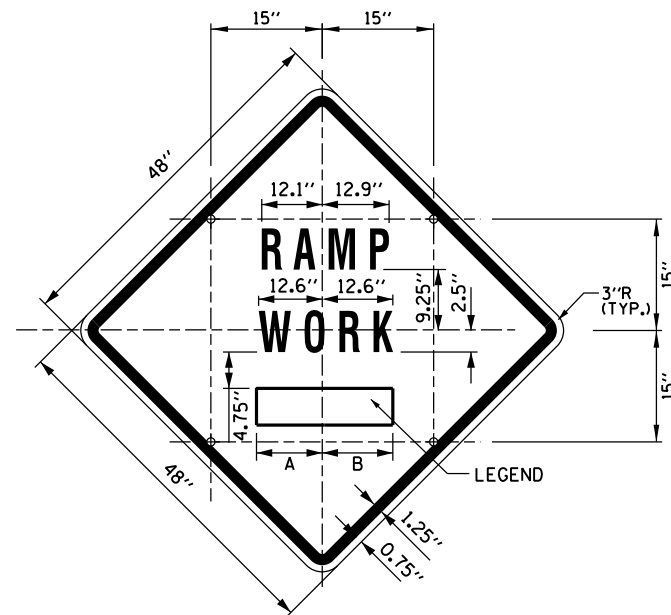

**SIGN TS-2 (O)**

COLOR: BACKGROUND - FLUORESCENT ORANGE (O)  
 BORDER AND SYMBOL - BLACK  
 SIZE: 48"x48"  
 LETTERING: 7" FEDERAL SERIES D  
 MOUNTING HOLES: 7/16" DIA., 4 HOLES SPACED AS SHOWN

SIGN NO.	LEGEND	A	B
TS-2A	AHEAD	15.50"	15.50"
TS-2B	500 FT	14.25"	15.13"
TS-2C	1000 FT	14.88" L2	15.75" L2
TS-2D	1500 FT	14.88" L2	15.75" L2
TS-2E	1/2 MILE	15.75" L3	15.75" L3
TS-2F	1 MILE	13.06"	13.06"

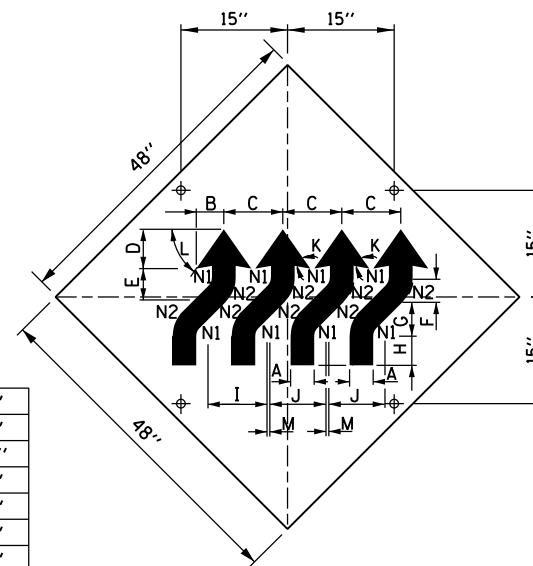

**SIGN WI-4dR (O)**

A	4 1/2"
B	5 3/4"
C	12 1/2"
D	7 3/4"
E	6 1/2"
F	4 1/2"
G	6 1/2"
H	6"
I	12 3/4"
J	12"
K	45°
L	55°
M	0 3/4"
N1	2"
N2	6 1/2"

COLOR: BACKGROUND, FLUORESCENT ORANGE (O)  
 TYPE A REFLECTIVE SHEETING PER STANDARD SPECIFICATIONS (\*A)  
 BORDER AND LETTERS-BLACK  
 SIZE: 48"x48"  
 MOUNTING HOLES: 7/16" DIA., 4 HOLES SPACED AS SHOWN.

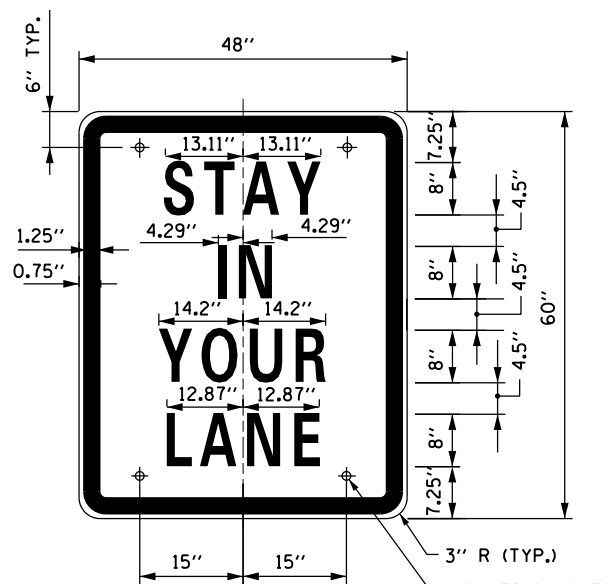

**SIGN TS-3**

COLOR: BACKGROUND - WHITE (REFLECTORIZED)(\*A)  
 BORDER AND LETTERS - BLACK  
 SIZE: 48"x60"  
 LETTERING: LEGEND - 8" FEDERAL SERIES D  
 MOUNTING HOLES: 7/16" DIA., 4 HOLES, SPACED AS SHOWN

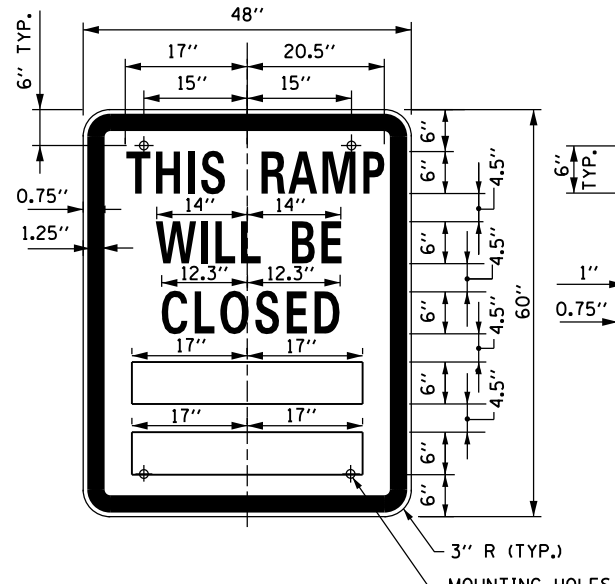

**SIGN TS-4**

COLOR: BACKGROUND - WHITE (REFLECTORIZED)(\*A)  
 BORDER AND LETTERS - BLACK  
 SIZE: 48"x60"  
 LETTERING: LEGEND - 6" FEDERAL SERIES C  
 MOUNTING HOLES: 7/16" DIA., 4 HOLES, SPACED AS SHOWN

**RAMP CLOSURE ADVANCE INFORMATION SIGN**

THE VARIABLE MESSAGE WITH DATES FOR THE BOTTOM TWO LINES SHALL BE DETERMINED BY THE ENGINEER AND GIVEN TO THE CONTRACTOR BEFORE THE REQUIRED FIELD ERECTION DATE.

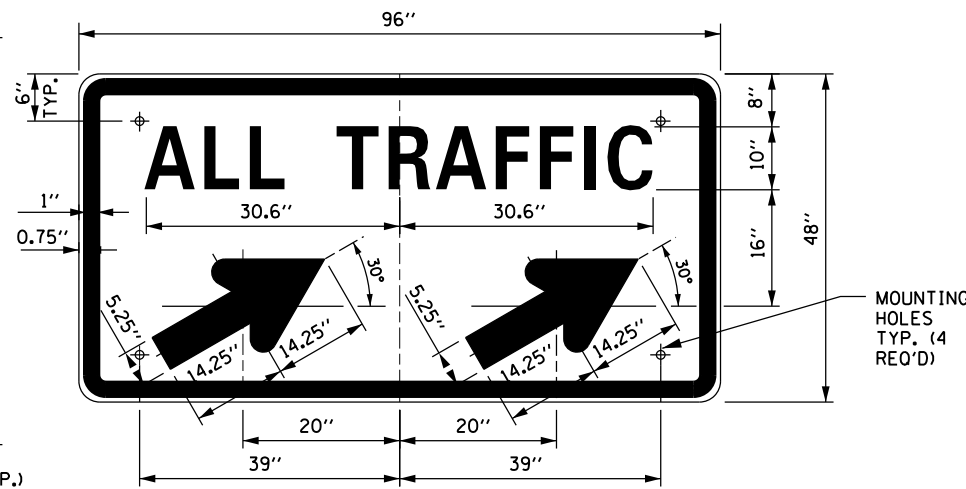

**SIGN TS-5a & TS-5b**

COLOR: BACKGROUND - WHITE (REFLECTORIZED)(\*A)  
 BORDER AND LETTERS - BLACK  
 ARROW - BLACK  
 SIZE: 96"x48"  
 LETTERING: 10" FEDERAL SERIES D  
 MOUNTING HOLES: 7/16" DIA., 4 HOLES, SPACED AS SHOWN  
 NOTE: SIGN TS-5a IS SHOWN, SUBSTITUTE LEGEND "↗" FOR "↖" FOR SIGN TS-5b

**NOTES:**

- ALL LETTERING IS DESIGNATED BY SIZE AND SERIES IN ACCORDANCE WITH THE LATEST EDITION OF "STANDARD ALPHABETS FOR HIGHWAY SIGNS AND PAVEMENT MARKINGS" AS PUBLISHED BY THE U.S. DEPARTMENT OF TRANSPORTATION. LETTERING SPACING SHALL BE IN ACCORDANCE WITH THIS GUIDE EXCEPT WHERE NOTED.
- SYMBOLS AND ARROWS SHALL CONFORM TO THE DETAILS SHOWN IN THE LATEST EDITION OF "STANDARD HIGHWAY SIGNS" AS PUBLISHED BY THE U.S. DEPARTMENT OF TRANSPORTATION.
- SEE THE CONTRACT REQUIREMENTS FOR ADDITIONAL NOTES AND SPECIFICATIONS.  
 (O) FLUORESCENT ORANGE REFLECTIVE SHEETING PER THE STANDARD SPECIFICATIONS.  
 (\*A) - REFLECTIVE SHEETING PER THE STANDARD SPECIFICATIONS.
- DIMENSIONS INDICATED THUS L ARE BASED ON A REDUCTION IN STANDARD LETTERING SPACING AS SHOWN BELOW:  
 L1 SPACING REDUCED BY 25%  
 L2 SPACING REDUCED BY 40%  
 L3 SPACING REDUCED BY 50%



DATE	REVISIONS
5-1-2009	DELETED FLASHING ARROW BOARDS
1-1-2011	ADDED SIGN COLOR DESIGNATION
11-1-2012	DELETED SIGN TS-1

APPROVED: *Paul Kovacs*  
 CHIEF ENGINEER DATE 5-1-2009

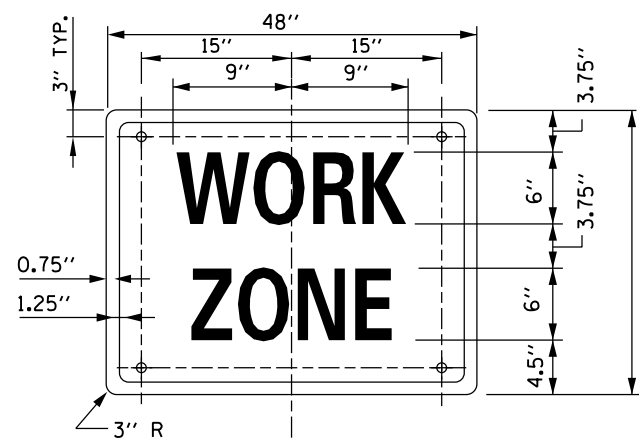

**SIGN G20-I102 (O)**

COLOR: BACKGROUND - FLUORESCENT ORANGE (O)  
 BORDER AND LETTERS - BLACK  
 SIZE: 48"x24"  
 LETTERING: 6" FEDERAL SERIES C,  
 MOUNTING HOLES: 7/16" DIA., 4 HOLES SPACED AS SHOWN  
 ON SIGN G20-2A

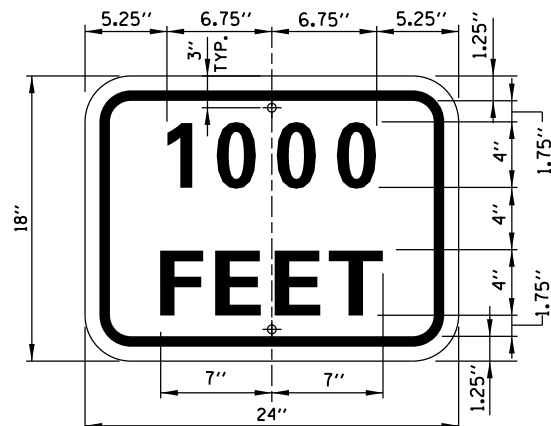

**SUPPLEMENTAL PLATE (O)**

COLOR: BACKGROUND - FLUORESCENT ORANGE (O)  
 BORDER AND LETTERS - BLACK  
 SIZE: 24"x18"  
 LETTERING: 4" FEDERAL SERIES D  
 MOUNTING HOLES: 7/16" DIA.

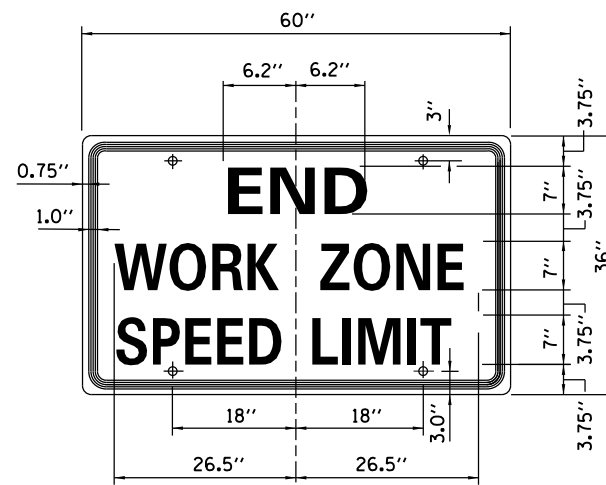

**SIGN G20-I103 (O)**

COLOR: BACKGROUND - FLUORESCENT ORANGE (O)  
 BORDER AND LETTERS - BLACK  
 SIZE: 60"x36"  
 LETTERING: 6" FEDERAL SERIES C,  
 MOUNTING HOLES: 7/16" DIA., 4 HOLES SPACED AS SHOWN

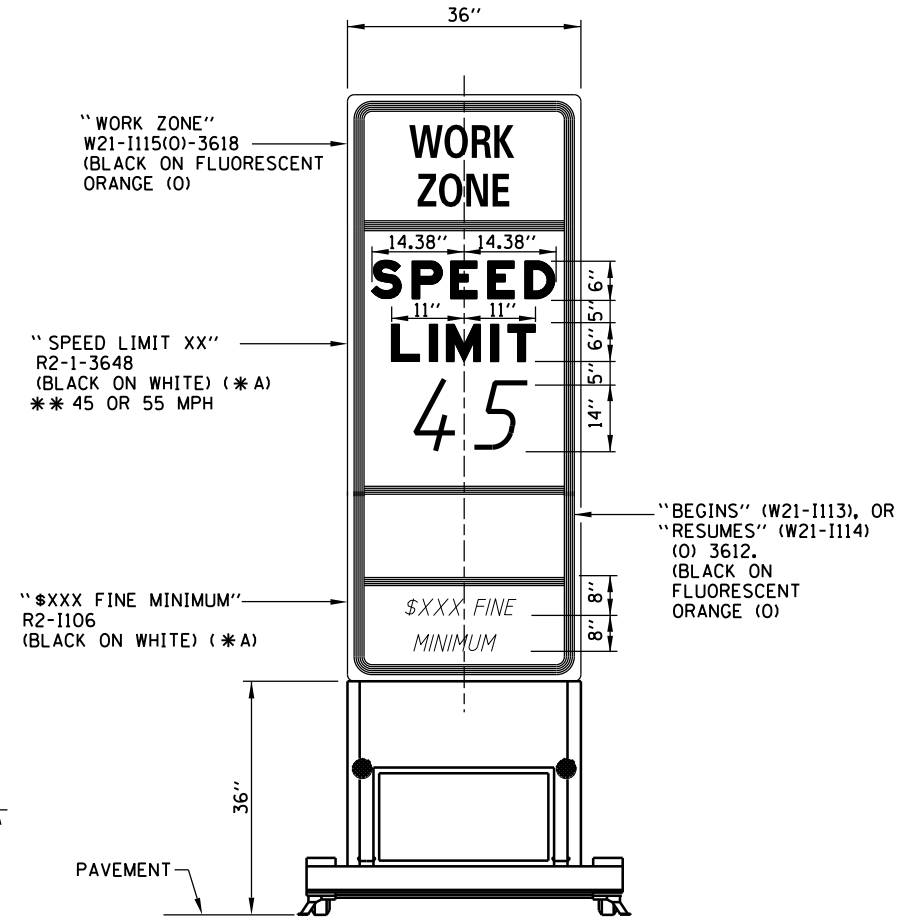

**WORK ZONE SPEED LIMIT SIGN ASSEMBLY**

**GENERAL NOTES:**

1. ALL LETTERING IS DESIGNATED BY SIZE AND SERIES IN ACCORDANCE WITH THE LATEST EDITION OF "STANDARD ALPHABETS FOR HIGHWAY SIGNS AND PAVEMENT MARKINGS" AS PUBLISHED BY THE U.S. DEPARTMENT OF TRANSPORTATION. LETTERING SPACING SHALL BE IN ACCORDANCE WITH THE GUIDE EXCEPT WHERE NOTED.
2. SYMBOLS AND ARROWS SHALL CONFORM TO THE DETAILS SHOWN IN THE LATEST EDITION OF "STANDARD HIGHWAY SIGNS" AS PUBLISHED BY THE U.S. DEPARTMENT OF TRANSPORTATION.
3. SEE THE CONTRACT REQUIREMENTS FOR ADDITIONAL NOTES AND SPECIFICATIONS.  
 (O) FLUORESCENT ORANGE REFLECTIVE SHEETING PER THE STANDARD SPECIFICATIONS.  
 (\*A)-REFLECTIVE SHEETING PER THE STANDARD SPECIFICATIONS.

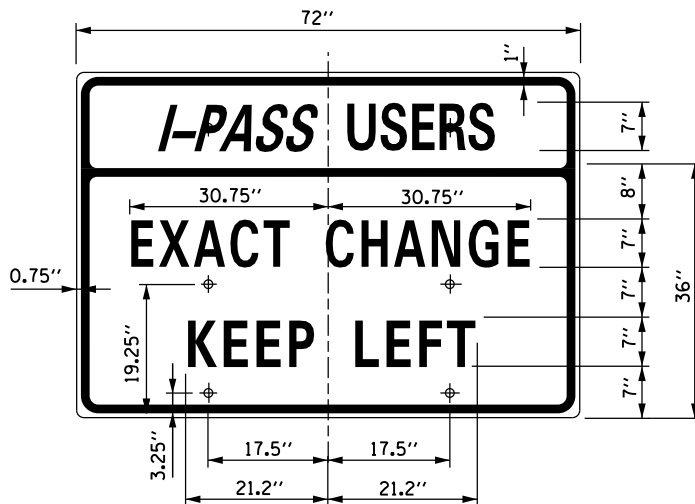

**SIGN TS-7**

COLOR: BACKGROUND - WHITE (REFLECTORIZED) (\*A)  
 BORDER AND LETTERS - BLACK  
 SIZE: 72"x36"  
 LETTERING: 7" FEDERAL SERIES C  
 MOUNTING HOLES: 7/16" DIA., 4 HOLES SPACED AS SHOWN

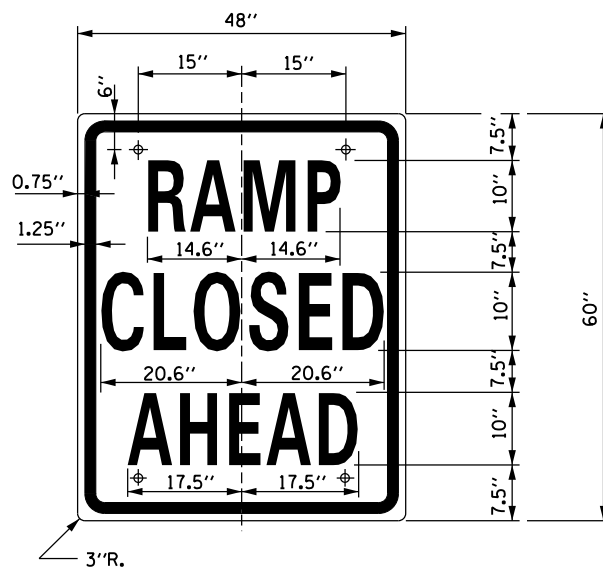

**SIGN TS-9**

COLOR: BACKGROUND - WHITE (REFLECTORIZED)  
 BORDER AND LETTERS - BLACK  
 SIZE: 48"x60"  
 LETTERING: 10" FEDERAL SERIES C  
 MOUNTING HOLES: 7/16" DIA., 4 HOLES SPACED AS SHOWN

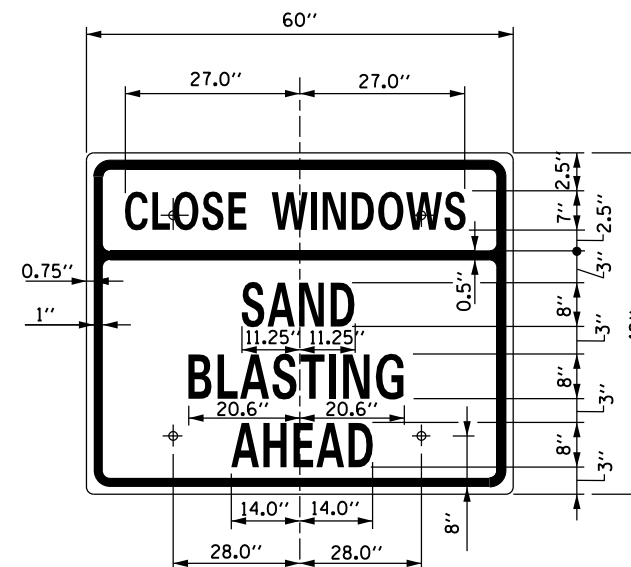

**SIGN TS-10 (O)**

COLOR: BACKGROUND - FLUORESCENT ORANGE (O)  
 BORDER AND LETTERS - BLACK  
 SIZE: 60"x48"  
 LETTERING: 8" FEDERAL SERIES C, 7" FEDERAL SERIES B  
 MOUNTING HOLES: 7/16" DIA., 4 HOLES SPACED AS SHOWN

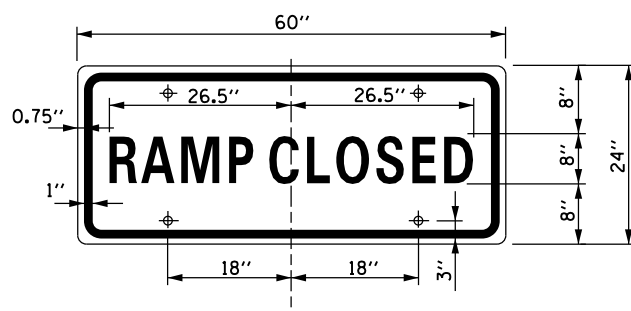

**SIGN TS-6**

COLOR: BACKGROUND - WHITE (REFLECTORIZED)  
 BORDER AND LETTERS - BLACK  
 SIZE: 60"x24"  
 LETTERING: 8" FEDERAL SERIES C  
 MOUNTING HOLES: 7/16" DIA., 4 HOLES SPACED AS SHOWN

APPROVED *Paul Kovacs* CHIEF ENGINEER DATE 5-1-2009

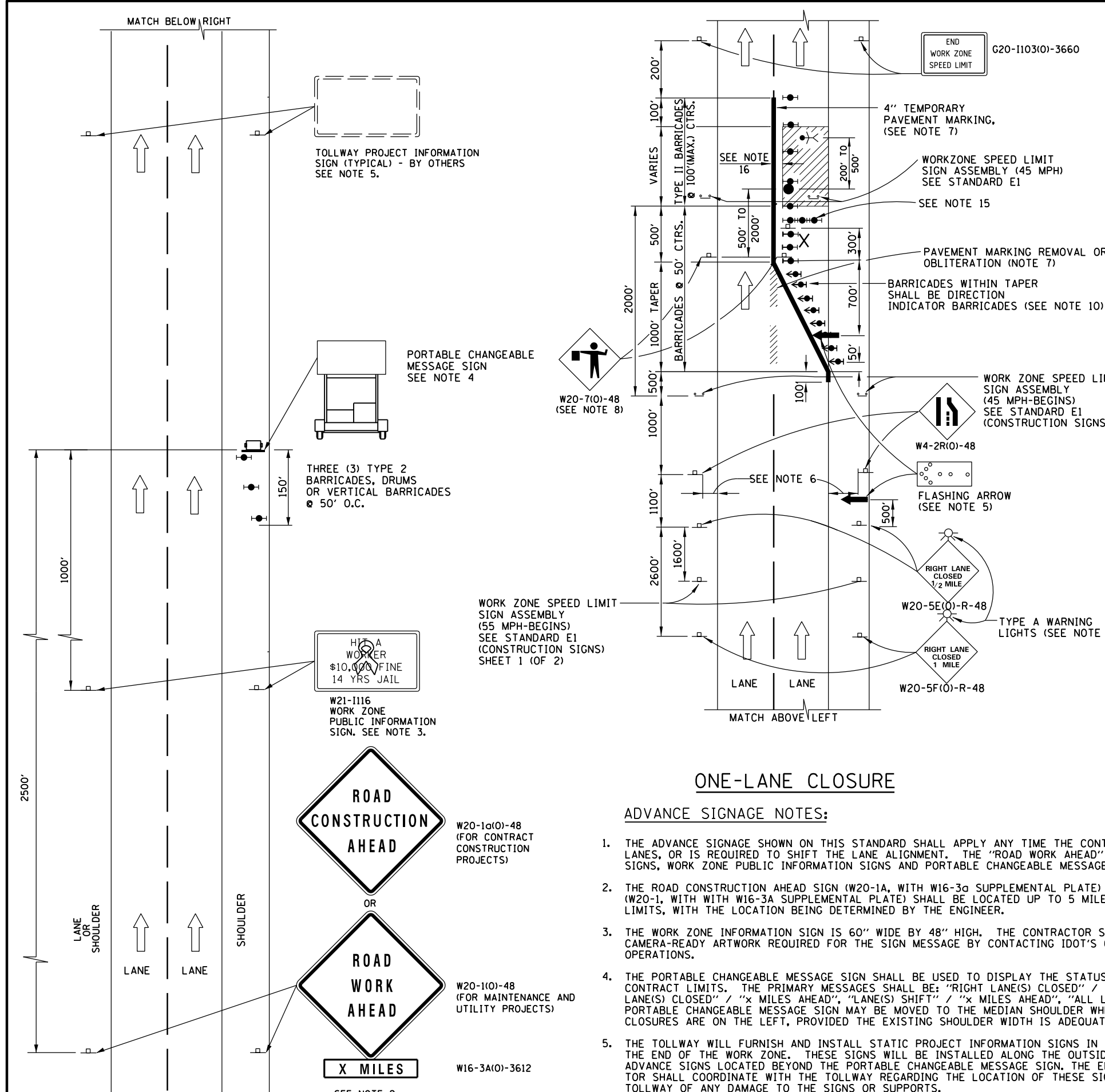

**LANE CLOSURE NOTES:**

- IF CLOSURES ARE EXPECTED TO PRODUCE TRAFFIC BACKUPS EXTENDING BEYOND THE FIRST WARNING SIGN SHOWN ON THE DETAILS, ADDITIONAL UPSTREAM SIGNS SHALL BE PLACED SO THAT THE TRAFFIC CONTROL ZONE ENCOMPASSES THE ANTICIPATED BACKUP ZONE.
- LONGITUDINAL DIMENSIONS MAY BE ADJUSTED SLIGHTLY TO FIT FIELD CONDITIONS.
- THESE DETAILS ALSO APPLY TO OPPOSITE HAND LANE CLOSURES BY CHANGING SIGN LEGENDS AND ARROW DIRECTIONS TO INDICATE THE APPROPRIATE CLOSURE.
- FOR NIGHT TIME CLOSURES, ONE TYPE A WARNING LIGHT SHALL BE INSTALLED ABOVE EACH OF THE 1 MILE AND 1/2 MILE ADVANCE WARNING SIGNS. FOR DAYLIGHT-ONLY CLOSURES, THE LIGHTS MAY BE OMITTED.
- FOR ANY LANE CLOSURE, FLASHING ARROW BOARDS SHALL BE REQUIRED AND IN OPERATION AT ALL TIMES. THE FLASHING ARROW BOARD IN ADVANCE OF THE TAPER SHALL BE PROTECTED WITH THREE TYPE II BARRICADES AT 50' O.C.
- CONSTRUCTION SIGNS SHALL GENERALLY BE POST-MOUNTED OR ATTACHED TO PORTABLE SUPPORTS AND SHALL BE INSTALLED 8' TO 12' FROM ADJACENT TRAVEL LANE WHEREVER POSSIBLE. IN NO CASE SHALL SIGNS BE LOCATED TO PROVIDE LESS THAN 2' CLEARANCE BETWEEN EDGE OF SIGN AND ADJACENT TRAVEL LANE.
- PAVEMENT MARKING TAPE AND REMOVAL OR OBLITERATION OF EXISTING MARKINGS SHALL BE REQUIRED WHEN THE CLOSURE TIME EXCEEDS FOUR DAYS. THIS WORK SHALL BE MEASURED AND PAID FOR SEPARATELY.
- WHEN A FLAGGER IS NOT ON STATION, THE FLAGGER SIGN SHALL BE PROMPTLY REMOVED, COVERED OR TURNED TO FACE AWAY FROM TRAFFIC. FLAGGER SIGNS SHALL BE MOVED AS NECESSARY TO MAINTAIN THE REQUIRED SPACING BETWEEN THE SIGNS AND THE WORKERS IN EACH SEPARATE WORK ACTIVITY, PER THE TOLLWAY SUPPLEMENTAL SPECIFICATIONS.
- WHENEVER WORKERS ARE PRESENT AND WITHIN 12' OR LESS TO MOVING TRAFFIC, WORK ZONE SPEED LIMIT SIGN ASSEMBLIES, SHALL BE PLACED ADJACENT TO THE OPEN TRAFFIC LANE(S). WORK ZONE SPEED SIGNS SHALL BE MOVED AS NECESSARY TO MAINTAIN THE REQUIRED SPACING BETWEEN SIGNS AND THE WORKERS IN EACH SEPARATE WORK ACTIVITY PER THE TOLLWAY SUPPLEMENTAL SPECIFICATIONS.
- DIRECTION INDICATOR BARRICADES SHALL BE USED IN LANE TAPERS.
- FOR CLOSURES OTHER THAN SHORT TERM (SUNRISE TO ONE HOUR BEFORE SUNSET), THE MINIMUM HEIGHT OF THE SIGN FROM SHOULDER ELEVATION SHALL BE 7'-0".
- CONES MAY BE USED IN LIEU OF BARRICADES IN THE BUFFER AND WORK AREAS, WHEN THE CLOSURE IS FOR MAINTENANCE OPERATIONS.
- BARRICADES ARE TO BE LOCATED AT JOINT LINE WHEN WORK AREA EXTENDS UP TO JOINT UNLESS OTHERWISE SHOWN ON THE PLANS.
- SEE MAINTENANCE OF TRAFFIC DRAWINGS FOR ADDITIONAL SIGNING IN THIS AREA.
- CHECK BARRICADES SHALL BE PLACED IN THE MIDDLE OF THE CLOSED LANE AND AT THE SHOULDER AT 1000 FOOT CENTERS.
- A 1'-0" MINIMUM/2'-0" DESIRABLE SHY DISTANCE SHALL BE PROVIDED, MEASURED BETWEEN EDGE OF PAVEMENT LANE MARKING TO THE EDGE OF THE TRAFFIC CONTROL DEVICE.

**ONE-LANE CLOSURE**

**ADVANCE SIGNAGE NOTES:**

- THE ADVANCE SIGNAGE SHOWN ON THIS STANDARD SHALL APPLY ANY TIME THE CONTRACTOR CLOSES ONE OR MORE LANES, OR IS REQUIRED TO SHIFT THE LANE ALIGNMENT. THE "ROAD WORK AHEAD" OR "ROAD CONSTRUCTION AHEAD" SIGNS, WORK ZONE PUBLIC INFORMATION SIGNS AND PORTABLE CHANGEABLE MESSAGE ARE STATIONARY.
- THE ROAD CONSTRUCTION AHEAD SIGN (W20-1A, WITH W16-3a SUPPLEMENTAL PLATE) OR ROAD WORK AHEAD SIGN (W20-1, WITH W16-3a SUPPLEMENTAL PLATE) SHALL BE LOCATED UP TO 5 MILES IN ADVANCE OF THE PROJECT LIMITS, WITH THE LOCATION BEING DETERMINED BY THE ENGINEER.
- THE WORK ZONE INFORMATION SIGN IS 60" WIDE BY 48" HIGH. THE CONTRACTOR SHALL OBTAIN THE CAMERA-READY ARTWORK REQUIRED FOR THE SIGN MESSAGE BY CONTACTING IDOT'S CENTRAL BUREAU OF OPERATIONS.
- THE PORTABLE CHANGEABLE MESSAGE SIGN SHALL BE USED TO DISPLAY THE STATUS OF LANE WITHIN THE CONTRACT LIMITS. THE PRIMARY MESSAGES SHALL BE: "RIGHT LANE(S) CLOSED" / "x MILES AHEAD", "LEFT LANE(S) CLOSED" / "x MILES AHEAD", "LANE(S) SHIFT" / "x MILES AHEAD", "ALL LANES OPEN". THE PORTABLE CHANGEABLE MESSAGE SIGN MAY BE MOVED TO THE MEDIAN SHOULDER WHEN THE LANE CLOSURES ARE ON THE LEFT, PROVIDED THE EXISTING SHOULDER WIDTH IS ADEQUATE.
- THE TOLLWAY WILL FURNISH AND INSTALL STATIC PROJECT INFORMATION SIGNS IN ADVANCE, THROUGH AND AT THE END OF THE WORK ZONE. THESE SIGNS WILL BE INSTALLED ALONG THE OUTSIDE SHOULDER WITH THE ADVANCE SIGNS LOCATED BEYOND THE PORTABLE CHANGEABLE MESSAGE SIGN. THE ENGINEER AND CONTRACTOR SHALL COORDINATE WITH THE TOLLWAY REGARDING THE LOCATION OF THESE SIGNS AND NOTIFY THE TOLLWAY OF ANY DAMAGE TO THE SIGNS OR SUPPORTS.

**SYMBOLS**

- ARROW BOARD
- WORK AREA
- SIGN
- DIRECTION INDICATOR BARRICADE WITH STEADY BURN MONODIRECTIONAL LIGHT
- TYPE II BARRICADE, DRUM, OR VERTICAL BARRICADE WITH STEADY BURN MONODIRECTIONAL LIGHT
- FLAGGER WITH TRAFFIC CONTROL SIGN
- WORKER
- LANE CLOSED



DATE	REVISIONS
5-1-2009	CHANGED TRAFFIC CONTROL DIMENSIONS UPDATED ROADWAY SIGNAGE
1-1-2011	CHANGED SYMBOL DESIGNATION, REVISED NOTES
11-1-2012	ADDED THREE LANE CLOSURE

LANE CLOSURE DETAILS

STANDARD E2-03

APPROVED *Paul Kovacs* CHIEF ENGINEER DATE 5-1-2009

- SYMBOLS**
- ARROW BOARD
  - WORK AREA
  - SIGN
  - DIRECTION INDICATOR BARRICADE WITH STEADY BURN MONODIRECTIONAL LIGHT
  - TYPE II BARRICADE, DRUM, OR VERTICAL BARRICADE WITH STEADY BURN MONODIRECTIONAL LIGHT
  - FLAGGER WITH TRAFFIC CONTROL SIGN
  - WORKER
  - LANE CLOSED

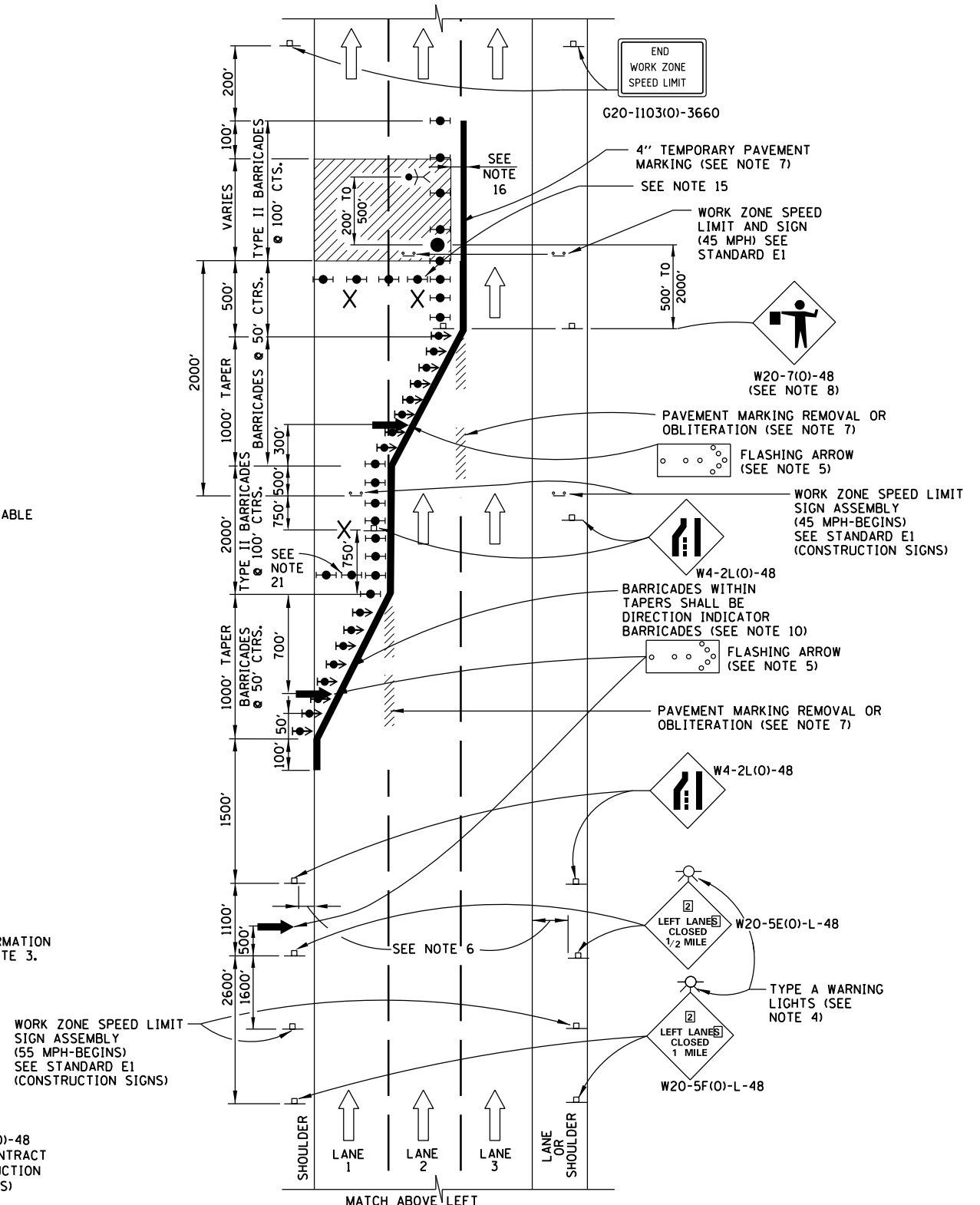
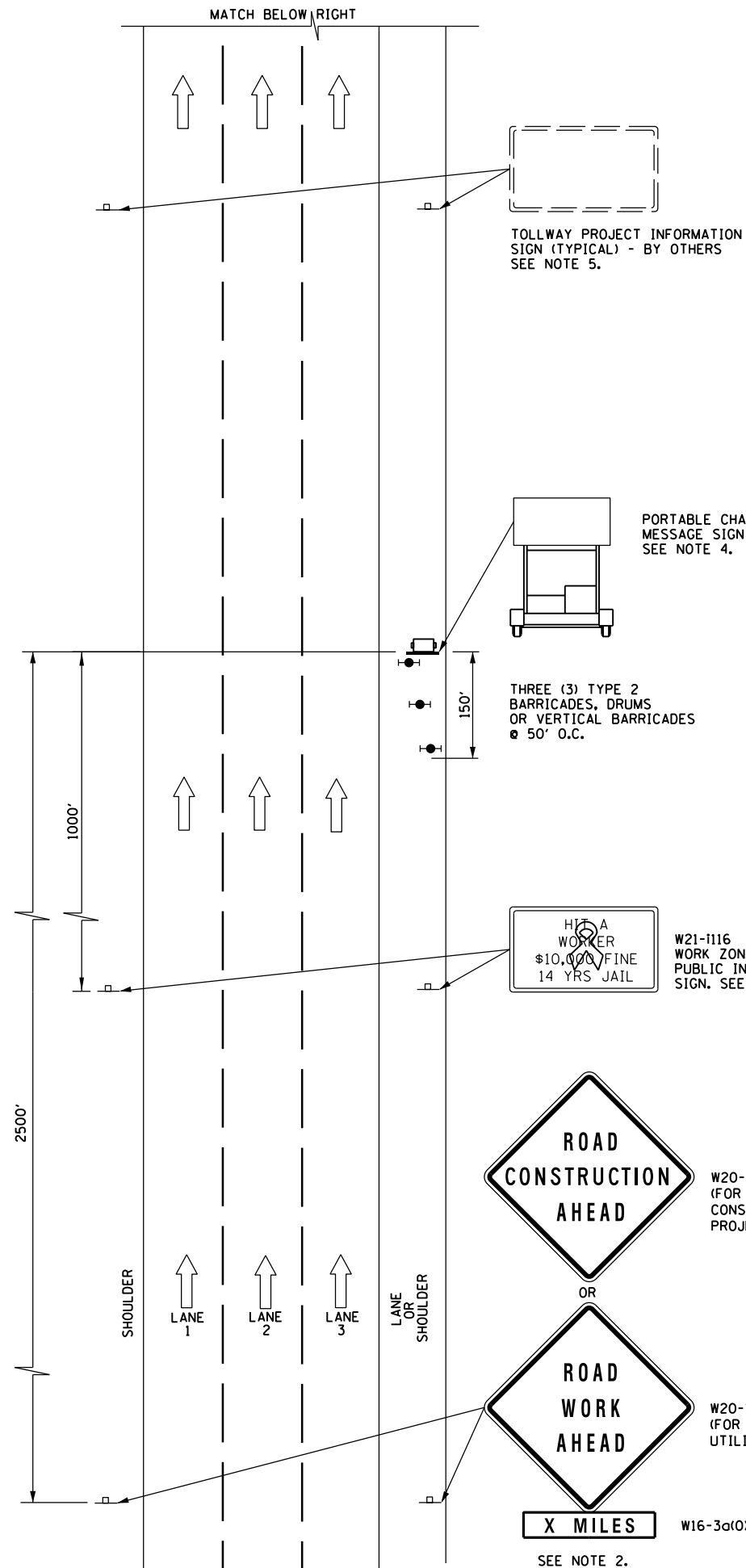

**TWO-LANE CLOSURE**

SEE SHEET 1 IN THIS SERIES FOR GENERAL NOTES



APPROVED *Paul Kovacs* CHIEF ENGINEER DATE 5-1-2009

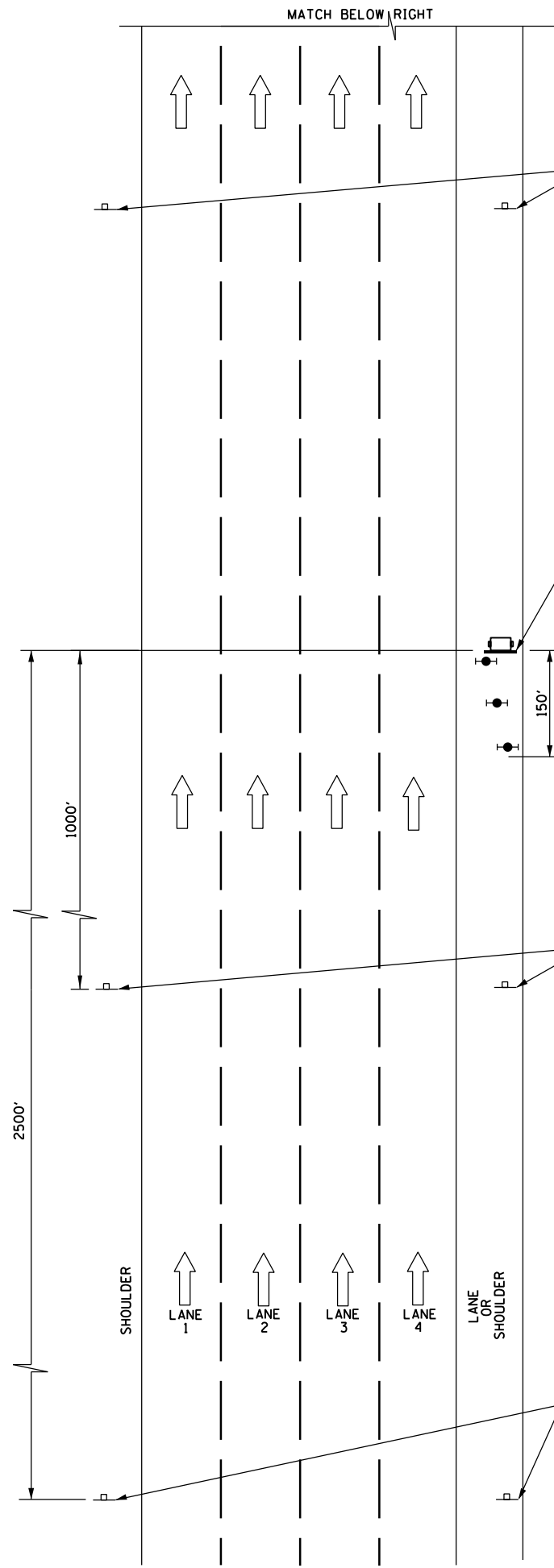

TOLLWAY PROJECT INFORMATION SIGN (TYPICAL) - BY OTHERS SEE NOTE 5.

PORTABLE CHANGEABLE MESSAGE SIGN SEE NOTE 4.

THREE (3) TYPE 2 BARRICADES, DRUMS OR VERTICAL BARRICADES @ 50' O.C.

HIT A WORKER \$10,000 FINE 14 YRS JAIL  
W21-1116 WORK ZONE PUBLIC INFORMATION SIGN. SEE NOTE 3.

ROAD CONSTRUCTION AHEAD  
OR  
ROAD WORK AHEAD  
X MILES  
W16-3a(0)-3612  
SEE NOTE 2.

W20-1a(0)-48 (FOR CONTRACT CONSTRUCTION PROJECTS)

W20-1(0)-48 (FOR MAINTENANCE AND UTILITY PROJECTS)

WORK ZONE SPEED LIMIT SIGN ASSEMBLY (55 MPH-BEGIN) SEE STANDARD E1 (CONSTRUCTION SIGNS)

SEE SHEET 1 IN THIS SERIES FOR GENERAL NOTES

**SYMBOLS**

- ARROW BOARD
- WORK AREA
- SIGN
- DIRECTION INDICATOR BARRICADE WITH STEADY BURN MONODIRECTIONAL LIGHT
- TYPE II BARRICADE, DRUM, OR VERTICAL BARRICADE WITH STEADY BURN MONODIRECTIONAL LIGHT
- FLAGGER WITH TRAFFIC CONTROL SIGN
- WORKER
- LANE CLOSED

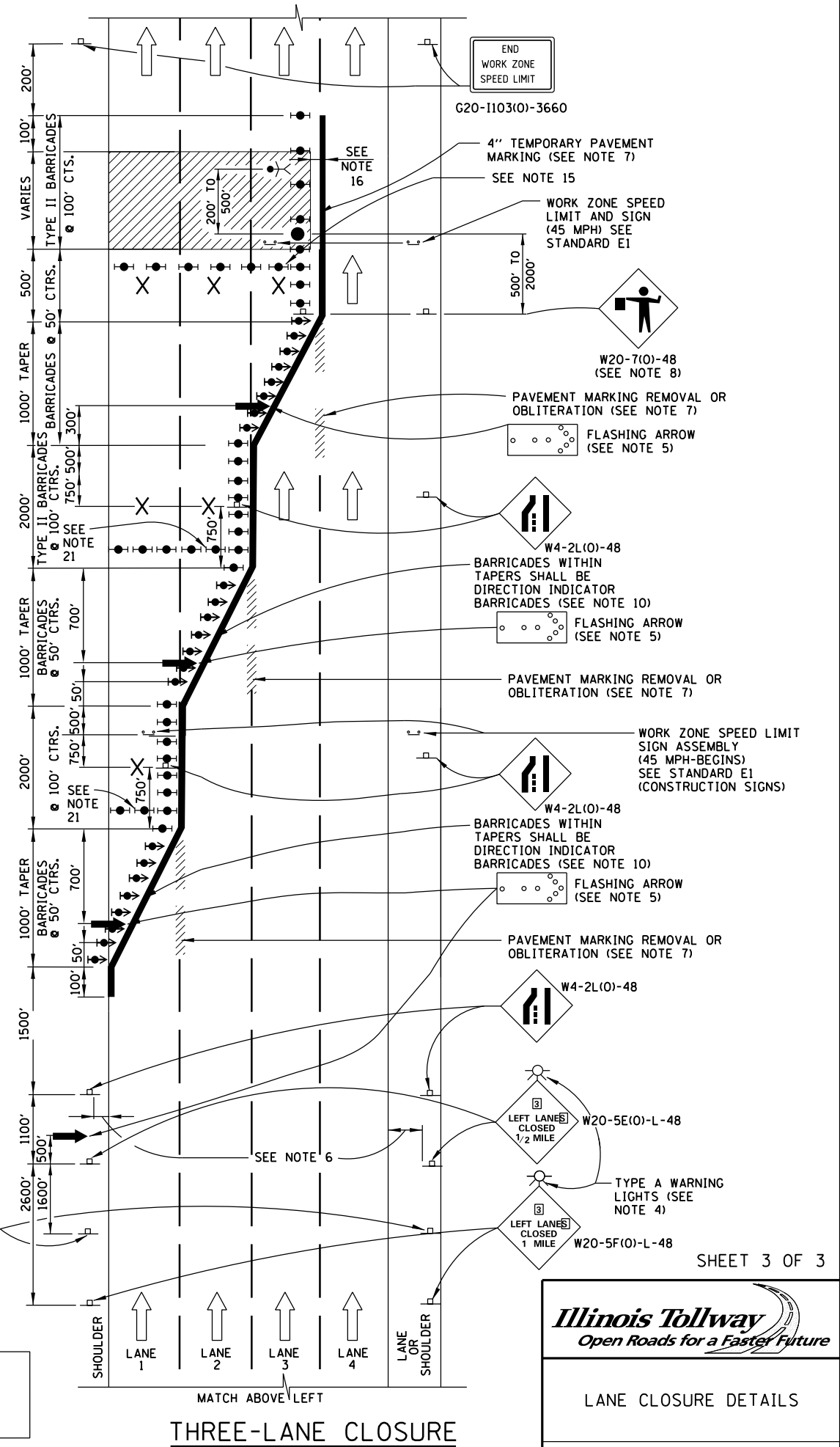

END WORK ZONE SPEED LIMIT  
G20-1103(0)-3660

4" TEMPORARY PAVEMENT MARKING (SEE NOTE 7)  
SEE NOTE 15

WORK ZONE SPEED LIMIT AND SIGN (45 MPH) SEE STANDARD E1

W20-7(0)-48 (SEE NOTE 8)

PAVEMENT MARKING REMOVAL OR OBLITERATION (SEE NOTE 7)  
FLASHING ARROW (SEE NOTE 5)

W4-2L(0)-48 BARRICADES WITHIN TAPERS SHALL BE DIRECTION INDICATOR BARRICADES (SEE NOTE 10)  
FLASHING ARROW (SEE NOTE 5)

PAVEMENT MARKING REMOVAL OR OBLITERATION (SEE NOTE 7)

WORK ZONE SPEED LIMIT SIGN ASSEMBLY (45 MPH-BEGIN) SEE STANDARD E1 (CONSTRUCTION SIGNS)

W4-2L(0)-48 BARRICADES WITHIN TAPERS SHALL BE DIRECTION INDICATOR BARRICADES (SEE NOTE 10)  
FLASHING ARROW (SEE NOTE 5)

PAVEMENT MARKING REMOVAL OR OBLITERATION (SEE NOTE 7)

W4-2L(0)-48

LEFT LANES CLOSED 1/2 MILE  
W20-5E(0)-L-48

TYPE A WARNING LIGHTS (SEE NOTE 4)

LEFT LANES CLOSED 1 MILE  
W20-5F(0)-L-48

SHEET 3 OF 3

**Illinois Tollway**  
Open Roads for a Faster Future

LANE CLOSURE DETAILS

STANDARD E2-03

THREE-LANE CLOSURE

APPROVED *Paul Kovacs* CHIEF ENGINEER DATE 5-1-2009

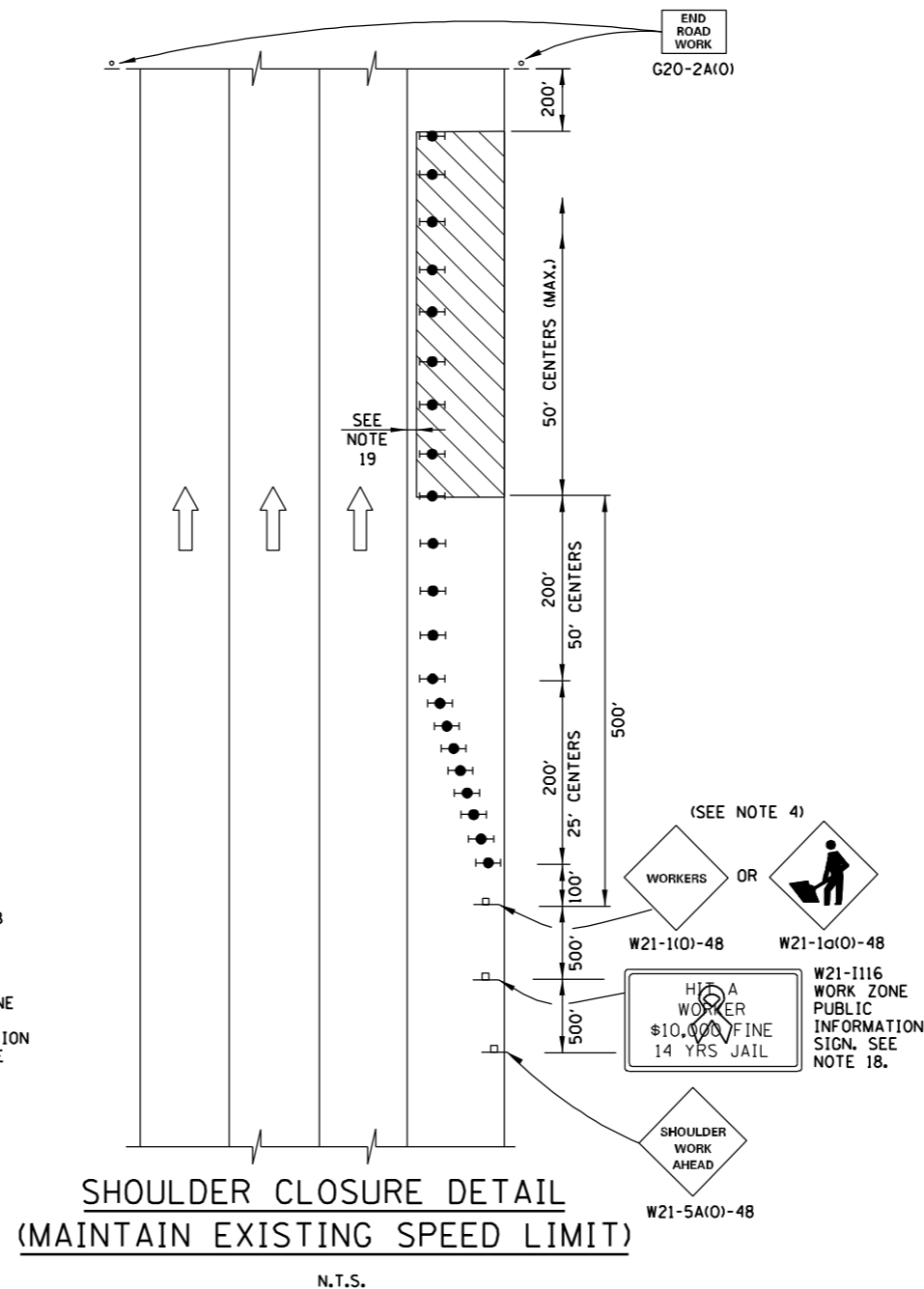
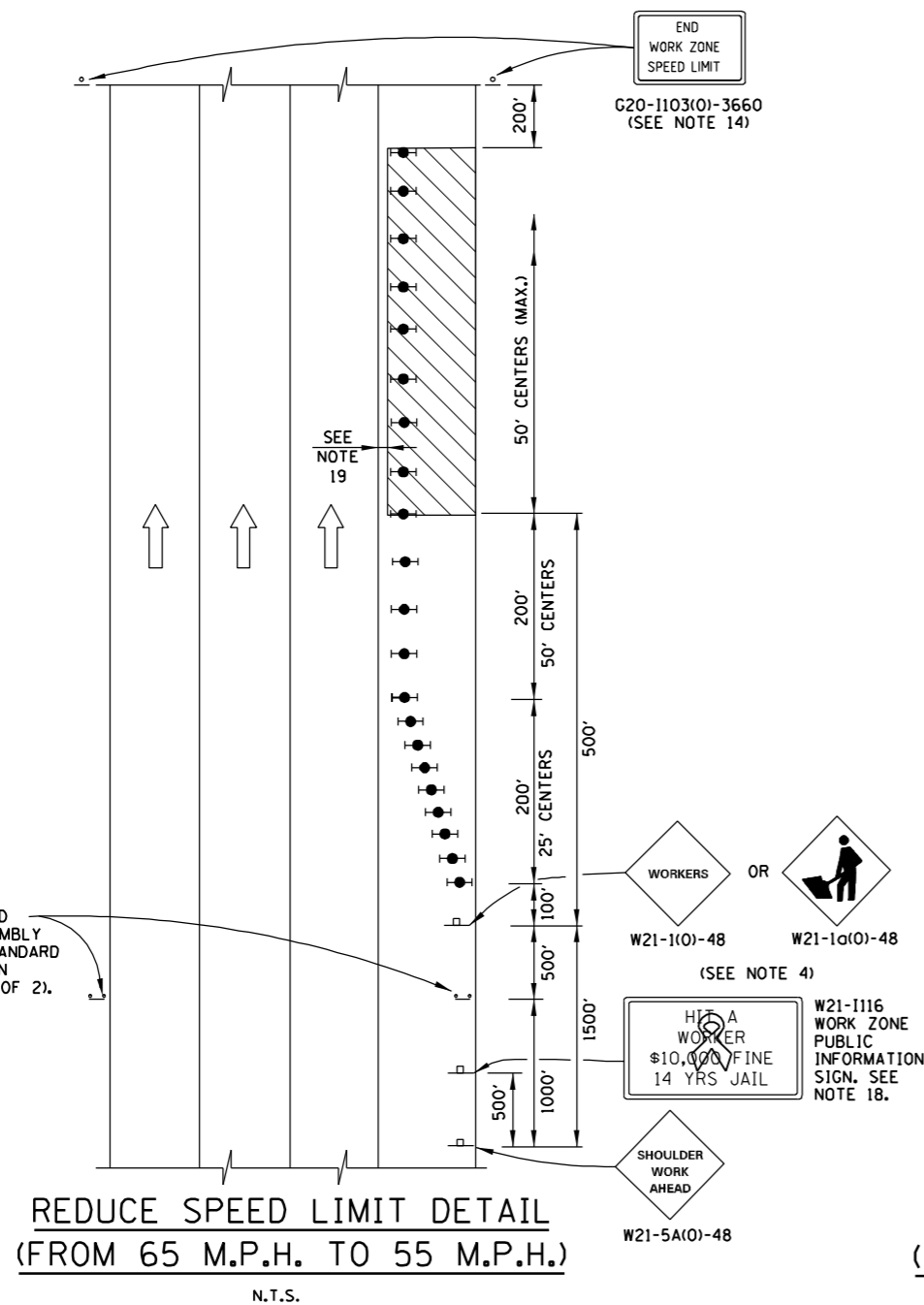

**GENERAL NOTES:**

1. THE SHOULDER SHALL BE CLOSED WHEN A WORK ACTIVITY REQUIRING 15 OR MORE MINUTES IS PERFORMED AT A DISTANCE WHICH IS LESS THAN 15 FEET BUT NO CLOSER THAN 2 FEET THE EDGE OF PAVEMENT.
2. THE ADJACENT EXTERIOR LANE SHALL BE CLOSED WHEN WORK IS PERFORMED WITHIN 2 FEET FROM THE EDGE OF PAVEMENT.
3. THE CHANNELIZING DEVICES WHICH SEPARATE THE WORK SPACE FROM THE ADJACENT TRAVEL LANE SHALL BE SPACED AT 25' FOR (200 FEET) AND AT A MAXIMUM OF 50' FOR ALL ADDITIONAL DEVICES.
4. WHEN THE WORKSITE IS UNATTENDED, SUBSTITUTE - "SHOULDER WORK AHEAD" SIGN FOR THE SECOND SIGN.
5. WORKER SIGNS OR SHOULDER WORK SIGNS AND CHANNELIZATION DEVICES ARE PLACED ONLY ON THE SIDE OF THE ROADWAY ON WHICH THE ACTIVITY IS PERFORMED.
6. FOR SHOULDER CLOSURE EXTENDING OVERNIGHT, BARRICADE TYPE II WITH STEADY BURNING LIGHT, TYPE C SHALL BE USED.
7. FOR SHORT TERM CLOSURE (SUNRISE TO ONE HOUR BEFORE SUNSET) NOT EXTENDING INTO DARKNESS, CONES MAY BE USED.
8. ONE WORK ZONE SPEED LIMIT SIGN ASSEMBLY (55 MPH - BEGINS) SHALL BE PLACED AT A DISTANCE OF 500' TO 2,500' MAXIMUM IN ADVANCE OF WORKERS THROUGHOUT THE SHOULDER CLOSURE. MOVING OPERATIONS MAY REQUIRE CONTINUOUS ADJUSTMENT OF THE SIGN ASSEMBLY LOCATION TO MAINTAIN THE ABOVE INTERVAL.
9. AN ADDITIONAL SIGN ASSEMBLY SHALL BE PLACED 500' BEYOND THE LAST ENTRANCE RAMP FOR EACH INTERCHANGE THAT FALLS WITHIN THE 2,500'.
10. THE SIGN ASSEMBLY SHALL BE PLACED NO CLOSER THAN 500' TO ANY OTHER SIGN.
11. THE SIGN ASSEMBLY SHALL NOT BE UTILIZED WHEN WORKERS ARE BEHIND A TEMPORARY (MOVABLE BARRIER) WALL.
12. THE WORK ZONE SPEED LIMIT SIGNS AND SIGN ASSEMBLY SHALL BE PROMPTLY REMOVED OR COVERED WHEN WORKERS ARE NOT PRESENT OR CLOSE TO MOVING TRAFFIC.
13. ALL CONFLICTING SPEED LIMIT SIGNS SHALL BE COVERED OR REMOVED.
14. "END WORK ZONE SPEED LIMIT" SIGNS SHALL BE IN PLACE ONLY WHEN THE EXISTING POSTED SPEED > 55MPH.
15. FOR SHOULDER REPAIRS OR REPLACEMENT THE CHANNELIZING DEVICES SHALL BE PLACED AT THE EDGE OF PAVEMENT WHENEVER THE WORK ACTIVITIES RESULT IN A DROPOFF AT THE EDGE OF PAVEMENT.
16. "WORK ZONE SPEED LIMIT" SIGNS SHALL BE IN PLACE ONLY WHEN THE EXISTING POSTED SPEED > 55MPH.
17. ANY UNATTENDED OBSTACLE OR EXCAVATION LEFT ON THE SHOULDER OVERNIGHT SHALL BE PROTECTED BY TEMPORARY CONCRETE BARRIER.
18. THE WORK ZONE INFORMATION SIGN IS 60" WIDE BY 48" HIGH. THE CONTRACTOR SHALL OBTAIN THE CAMERA-READY ARTWORK REQUIRED FOR THE SIGN MESSAGE BY CONTACTING IDOT'S CENTRAL BUREAU OF OPERATIONS.
19. A 1'-0" MINIMUM/2'-0" DESIRABLE SHY DISTANCE SHALL BE PROVIDED, MEASURED BETWEEN EDGE OF PAVEMENT LANE MARKING TO THE EDGE OF THE TRAFFIC CONTROL DEVICE.

**SYMBOLS**

- WORK AREA
- SIGN
- TYPE II BARRICADE, DRUM, OR VERTICAL BARRICADE WITH STEADY BURN MONODIRECTIONAL LIGHT



DATE	REVISIONS
5-1-2009	MODIFIED SHOULDER CLOSURE DETAILS - MAINTAIN EXISTING SPEED LIMIT - SPEED REDUCTION - MOVED "TEMPORARY GORE DETAILS" TO E5
1-1-2011	CHANGED SYMBOL DESIGNATION REVISED NOTES

SHOULDER CLOSURE DETAILS

STANDARD E3-02

APPROVED: *Paul Kovacs* CHIEF ENGINEER DATE 5-1-2009

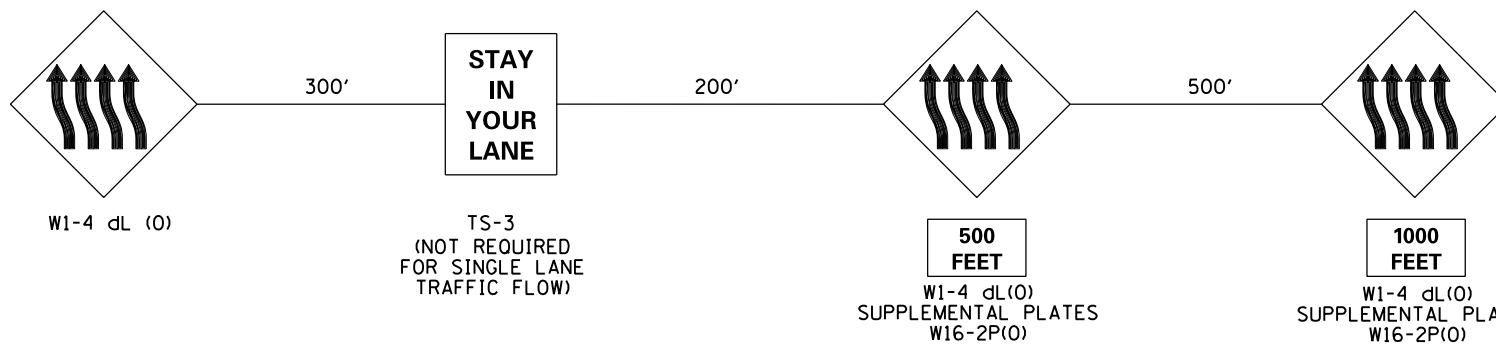

**ADVANCE WARNING SEQUENCE**

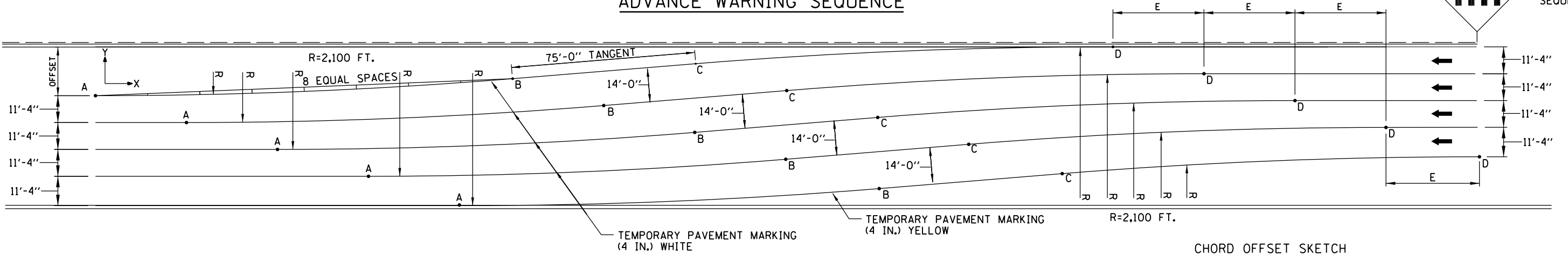

**CHORD OFFSET SKETCH**

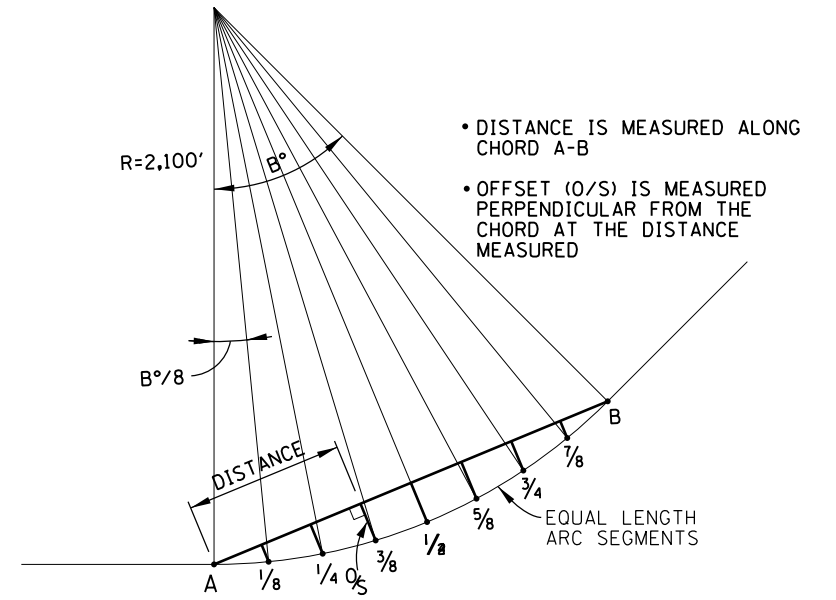

OFFSET	POINT LAY-OUT										CHORD OFFSET DATA							
	E	B°	A		B		C		D		1/8 & 7/8		1/4 & 3/4		3/8 & 5/8		1/2	
			X	Y	X	Y	X	Y	X	Y	O/S	DIST	O/S	DIST	O/S	DIST	O/S	DIST
10	50.23	3.06	0	0	112.2	3.0	187.1	7.0	299.2	10.0	0.3	14.0	0.6	28.0	0.7	42.1	0.7	56.1
12	44.94	3.43	0	0	125.6	3.8	200.4	8.2	326.0	12.0	0.4	15.7	0.7	31.4	0.9	47.1	0.9	62.8
14	40.96	3.77	0	0	138.0	4.5	212.8	9.5	350.8	14.0	0.5	17.3	0.9	34.5	1.1	51.8	1.1	69.0
16	37.86	4.08	0	0	149.5	5.3	224.3	10.7	373.9	16.0	0.6	18.7	1.0	37.4	1.2	56.1	1.3	74.8
18	35.34	4.38	0	0	160.4	6.1	235.2	11.9	395.6	18.0	0.7	20.1	1.2	40.1	1.4	60.2	1.5	80.3
20	33.26	4.66	0	0	170.7	7.0	245.5	13.0	416.2	20.0	0.8	21.4	1.3	42.7	1.6	64.1	1.7	85.4
22	31.50	4.93	0	0	180.5	7.8	255.3	14.2	435.8	22.0	0.9	22.6	1.5	45.2	1.8	67.8	1.9	90.4
24	30.00	5.19	0	0	189.9	8.6	264.6	15.4	454.6	24.0	0.9	23.8	1.6	47.5	2.0	71.3	2.2	95.1
26	28.68	5.44	0	0	199.0	9.4	273.6	16.6	472.6	26.0	1.0	24.9	1.8	49.8	2.2	74.7	2.4	99.6
28	27.53	5.67	0	0	207.7	10.3	282.3	17.7	489.9	28.0	1.1	26.0	1.9	52.0	2.4	78.0	2.6	104.0
30	26.51	5.90	0	0	216.0	11.1	290.6	18.9	506.7	30.0	1.2	27.0	2.1	54.1	2.6	81.1	2.8	108.2
32	25.59	6.13	0	0	224.2	12.0	298.7	20.0	522.9	32.0	1.3	28.0	2.3	56.1	2.8	84.2	3.0	112.2
34	24.76	6.34	0	0	232.0	12.9	306.6	21.1	538.6	34.0	1.4	29.0	2.4	58.1	3.0	87.1	3.2	116.2
36	24.02	6.55	0	0	239.7	13.7	314.2	22.3	553.8	36.0	1.5	30.0	2.6	60.0	3.2	90.0	3.4	120.0
38	23.33	6.76	0	0	247.1	14.6	321.6	23.4	568.7	38.0	1.6	30.9	2.7	61.9	3.4	92.8	3.7	123.8
40	22.71	6.96	0	0	254.3	15.5	328.8	24.5	583.1	40.0	1.7	31.8	2.9	63.7	3.6	95.5	3.9	127.4
42	22.13	7.15	0	0	261.4	16.3	335.8	25.7	597.2	42.0	1.8	32.7	3.1	65.4	3.8	98.2	4.1	131.0
44	21.60	7.34	0	0	268.3	17.2	342.7	26.8	611.0	44.0	1.9	33.6	3.2	67.2	4.0	100.8	4.3	134.4
46	21.11	7.53	0	0	275.0	18.1	349.4	27.9	624.4	46.0	2.0	34.4	3.4	68.9	4.2	103.3	4.5	137.8
48	20.65	7.71	0	0	281.6	19.0	356.0	29.0	637.6	48.0	2.1	35.2	3.6	70.5	4.5	105.8	4.7	141.1
50	20.22	7.89	0	0	288.1	19.9	362.4	30.1	650.5	50.0	2.2	36.1	3.7	72.2	4.7	108.3	5.0	144.4
52	19.82	8.06	0	0	294.4	20.7	368.7	31.3	663.1	52.0	2.3	36.9	3.9	73.7	4.9	110.7	5.2	147.6
54	19.44	8.23	0	0	300.6	21.6	374.9	32.4	675.5	54.0	2.4	37.6	4.1	75.3	5.1	113.0	5.4	150.7
56	19.09	8.40	0	0	306.7	22.5	380.9	33.5	687.7	56.0	2.5	38.4	4.2	76.8	5.3	115.3	5.6	153.8
58	18.76	8.56	0	0	312.7	23.4	386.9	34.6	699.6	58.0	2.6	39.2	4.4	78.3	5.5	117.6	5.9	156.8
60	18.44	8.73	0	0	318.6	24.3	392.7	35.7	711.4	60.0	2.7	39.9	4.6	79.8	5.7	119.8	6.1	159.8

**GENERAL NOTES:**

1. REVERSE CURVE INFORMATION CAN BE USED FOR SINGLE LANE OR MULTILANE TRAFFIC FLOWS, SHIFTING RIGHT TO LEFT (AS SHOWN) OR LEFT TO RIGHT BY CHANGING TO THE APPROPRIATE ADVANCE WARNING SEQUENCE.
2. THE REVERSE CURVE SHALL NOT BE USED OUTSIDE THE ACTIVITY AREA. LANE SHIFTS IN ADVANCE OF OR ON THE APPROACH TO THE ACTIVITY AREA SHALL BE IMPLEMENTED WITH A SHIFT RATE OF 83:1.
3. LANE SHIFTS FOR DEPARTURES OUT OF THE ACTIVITY AREA SHALL BE IMPLEMENTED WITH A SHIFT RATE OF 75:1.
4. DATA SHOWN FOR THIS REVERSE CURVE IS BASED ON A 45 MPH DESIGN AND WORKZONE SPEED.

**Paul Kovacs**  
 APPROVED CHIEF ENGINEER DATE 2-7-2012

DATE	REVISIONS
1-1-2011	ADDED SIGN COLOR DESIGNATION AND REVISED NOTES, MODIFIED LANE WIDTH DIMENSION/TABLE DATA.
2-7-2012	REVISED NOTES
11-1-2012	REVISED NOTES

**Illinois Tollway**  
*Open Roads for a Faster Future*

**MAINTENANCE OF TRAFFIC  
 REVERSE CURVE**

STANDARD E4-03



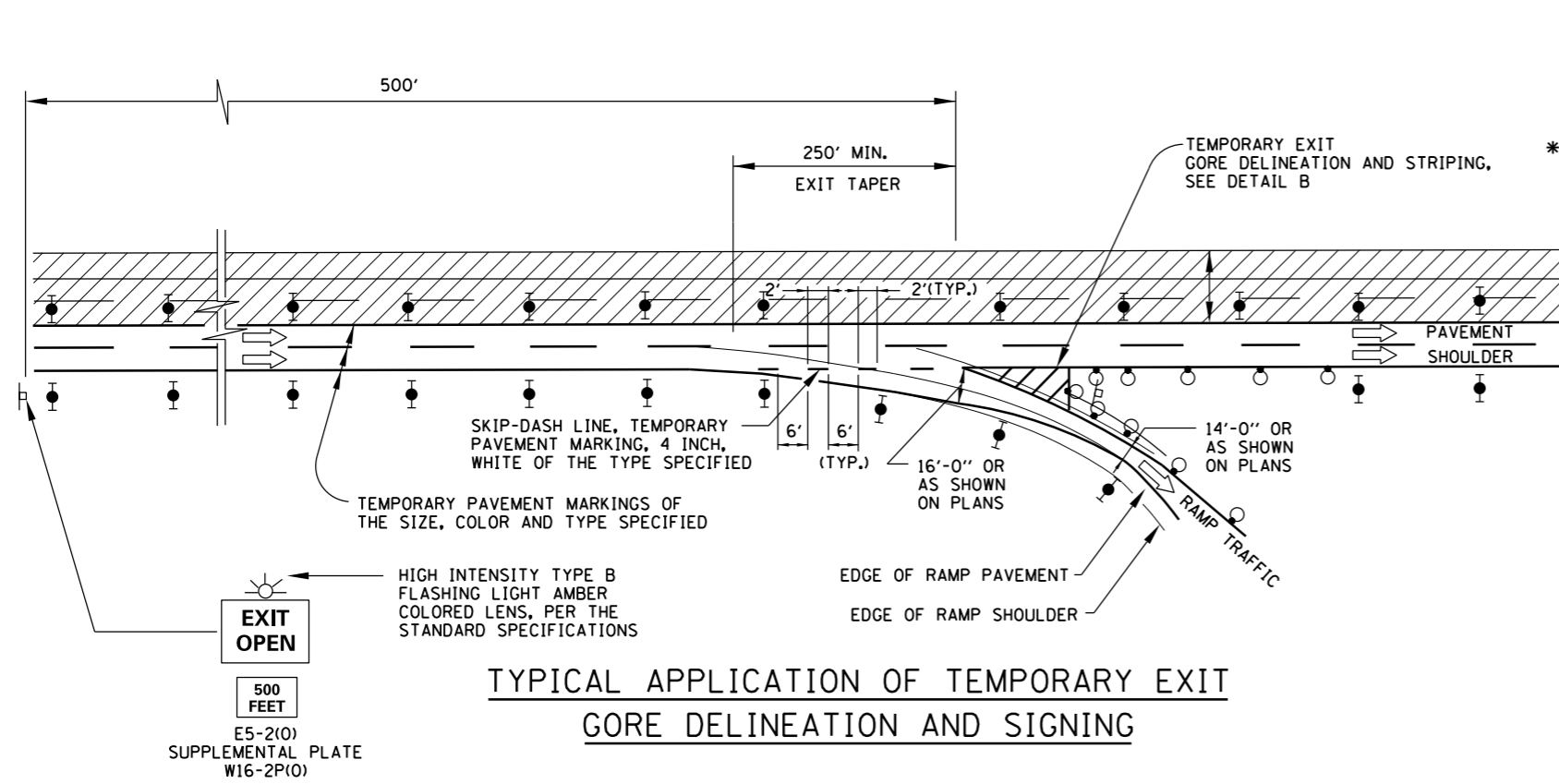

**TYPICAL APPLICATION OF TEMPORARY EXIT GORE DELINEATION AND SIGNING**

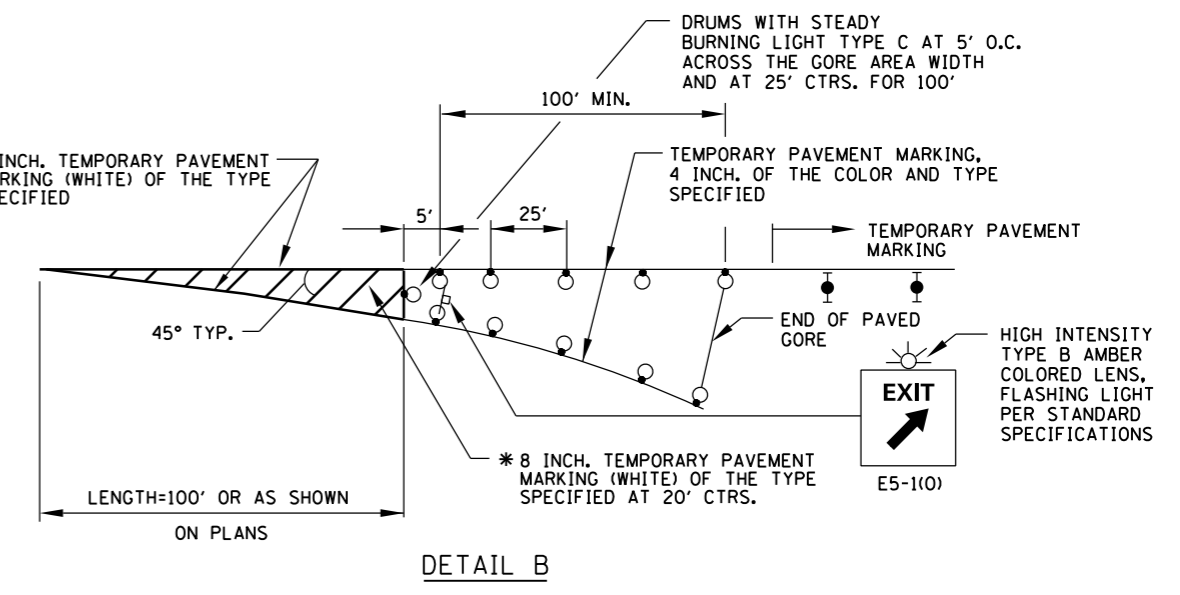

**TEMPORARY EXIT GORE DELINEATION AND SIGNING**

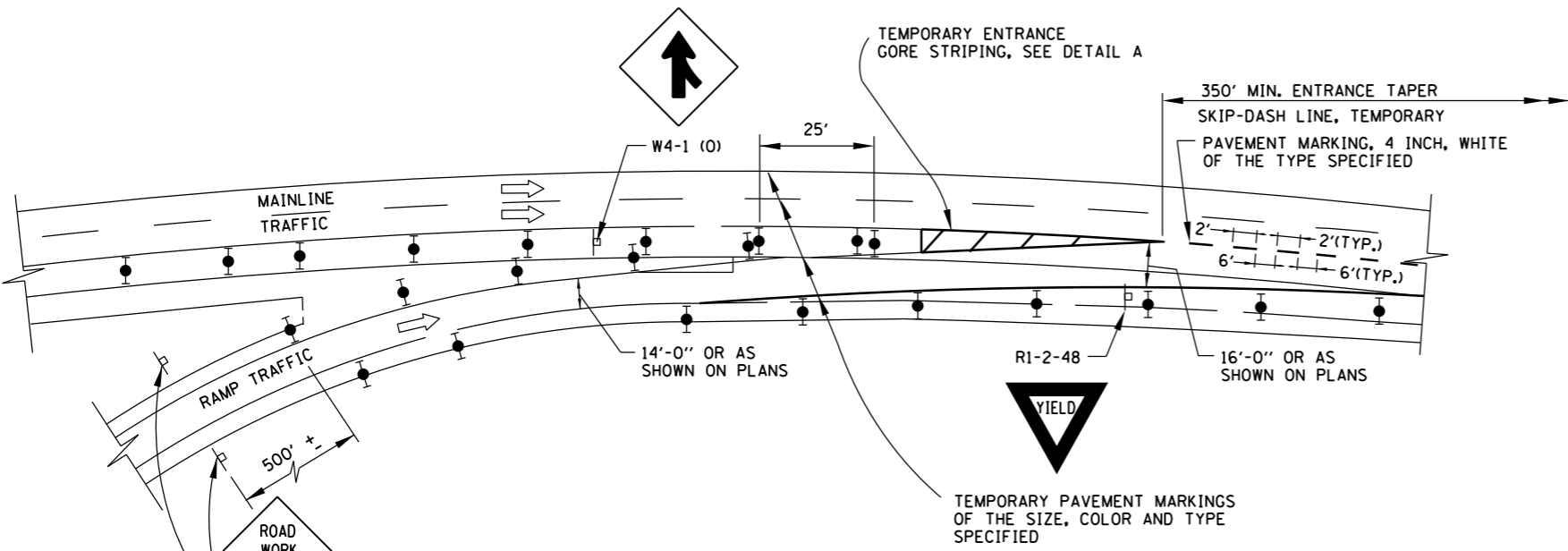

**TYPICAL APPLICATION OF TEMPORARY ENTRANCE GORE DELINEATION AND SIGNING**

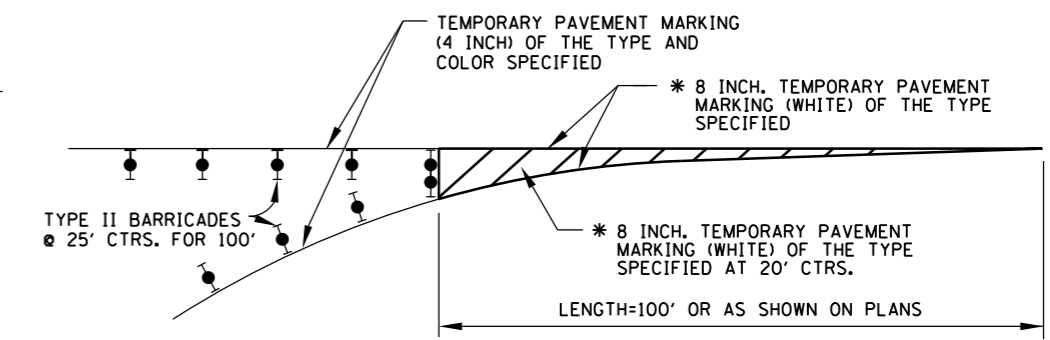

**TEMPORARY ENTRANCE GORE STRIPING**

**SYMBOLS**

- WORK AREA
- SIGN
- TYPE II BARRICADE, DRUM, OR VERTICAL BARRICADE WITH STEADY BURN MONODIRECTIONAL LIGHT
- DRUM WITH STEADY BURNING LIGHT

\* 8 INCH TEMPORARY PAVEMENT MARKING IS TO BE MADE OF 2-TEMPORARY PAVEMENT MARKING 4 INCH, WHITE OF THE TYPE SPECIFIED.

APPROVED *Paul Kovacs* CHIEF ENGINEER DATE 5-1-2009

DATE	REVISIONS
1-1-2011	CHANGED SYMBOL DESIGNATION
2-7-2012	REVISED MERGE SIGN

**Illinois Tollway**  
Open Roads for a Faster Future

TEMPORARY GORE DETAILS

STANDARD E5-02

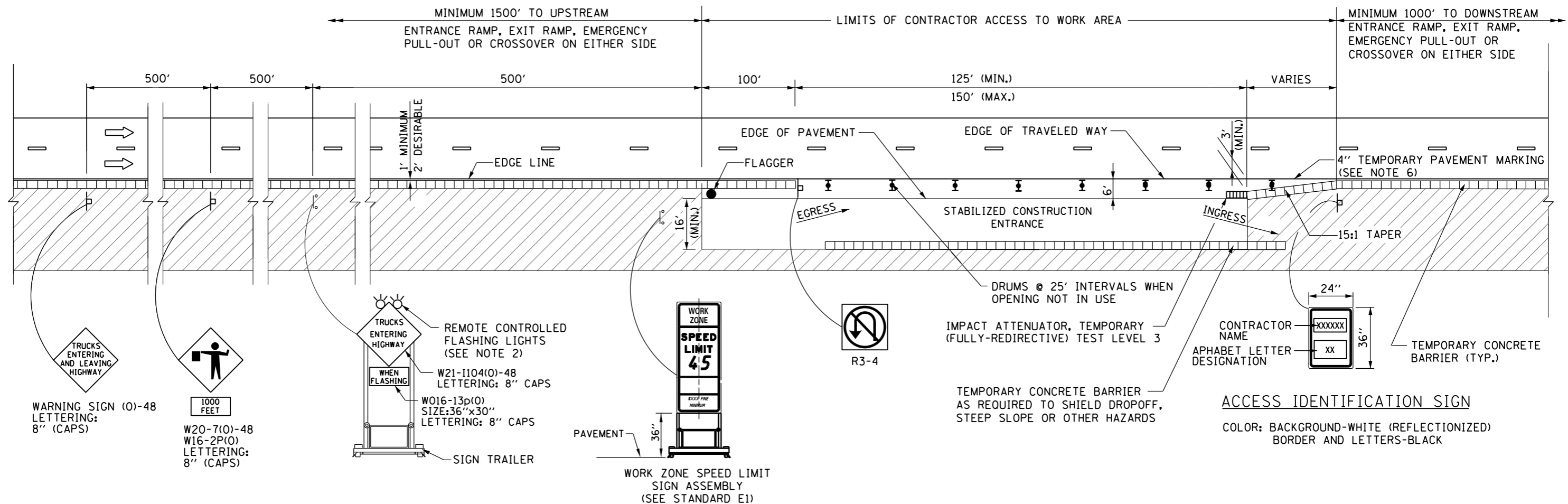

**NOTES:**

1. SIGNS DESIGNATED FOR THIS ACCESS TO WORK AREA SHALL BE COVERED OR TURNED AWAY FROM THE TRAFFIC WHEN THE FLAGGER IS NOT ON STATION AND THE ACCESS OPENINGS ARE NOT IN USE.
2. THE FLASHING WARNING LIGHT SHALL MEET THE REQUIREMENTS OF TOLLWAY SUPPLEMENTAL SPECIFICATIONS AND BE OPERATED BY THE FLAGGER REMOTELY. THE LIGHTS SHALL BE FLASHING ONLY WHEN A VEHICLE IS ENTERING THE TOLLWAY.
3. WHEN THREE LANES OR MORE ARE OPENED TO TRAFFIC, ADVANCE WARNING SIGNS AND ASSEMBLIES SHALL BE PROVIDED ON BOTH SIDES OF TRAVELED WAY.
4. WHEN CONTRACTOR ACCESS TO WORK AREA IS ON OPPOSITE SIDE FROM SHOWN, ALL INSTALLATIONS ARE MIRROR IMAGE.
5. FOR NIGHTTIME OPERATIONS, TEMPORARY LIGHTING OF CONSTRUCTION ACCESS TO WORK AREA SHALL BE PROVIDED.
6. TEMPORARY PAVEMENT MARKINGS SHALL BE REPLACED AS OFTEN AS NECESSARY TO DELINEATE OPENINGS.
7. IF POSSIBLE, LANE CLOSURES SHALL BE UTILIZED TO ELIMINATE THE MERGING OF CONSTRUCTION TRAFFIC INTO THROUGH TRAFFIC LANES.
8. A 1'-0" MINIMUM/2'-0" DESIRABLE SHY DISTANCE SHALL BE PROVIDED, MEASURED BETWEEN EDGE OF PAVEMENT LANE MARKING TO THE EDGE OF THE TRAFFIC CONTROL DEVICES.

**LEGEND**

- FLAGGER
- ⊥ CONSTRUCTION SIGN ON SUPPORT PER TOLLWAY STANDARD UNLESS NOTED
- DIRECTION OF TRAFFIC FLOW
- ▨ WORK AREA
- ⊕ DRUM WITH STEADY BURNING MONODIRECTIONAL LIGHT

APPROVED *Paul Kovacs* CHIEF ENGINEER DATE 2-7-2012

**CONTRACTOR ACCESS TO WORK AREA**

DATE	REVISIONS

**Illinois Tollway**  
Open Roads for a Faster Future

CONTRACTOR ACCESS TO WORK AREA

STANDARD E6-00

"EMERGENCY MOTORIST ASSIST" SIGN (O) 48"x48" TOLLWAY SUPPLIED, SEE NOTE 2 (ATTACH TO TEMPORARY BARRIER PARALLEL TO TRAFFIC)

STAY IN YOUR VEHICLE MOTORIST ASSIST ON PATROL YOUR LOCATION: DIR.-RT. SIGN-M.P.

EMERGENCY STOPPING ONLY  
R8-7 4836  
(ATTACH TO TEMPORARY BARRIER PARALLEL TO TRAFFIC)

EMERGENCY STOPPING ONLY  
R8-7 4836

EMERGENCY STOPPING ONLY  
1000 FEET  
R8-7 WITH SUPPLEMENTAL PLATE

LEFT SHOULDER CLOSED 500FT  
w21-5bL-B(0)-48

LEFT SHOULDER CLOSED 1000FT  
w21-5bL-C(0)-48

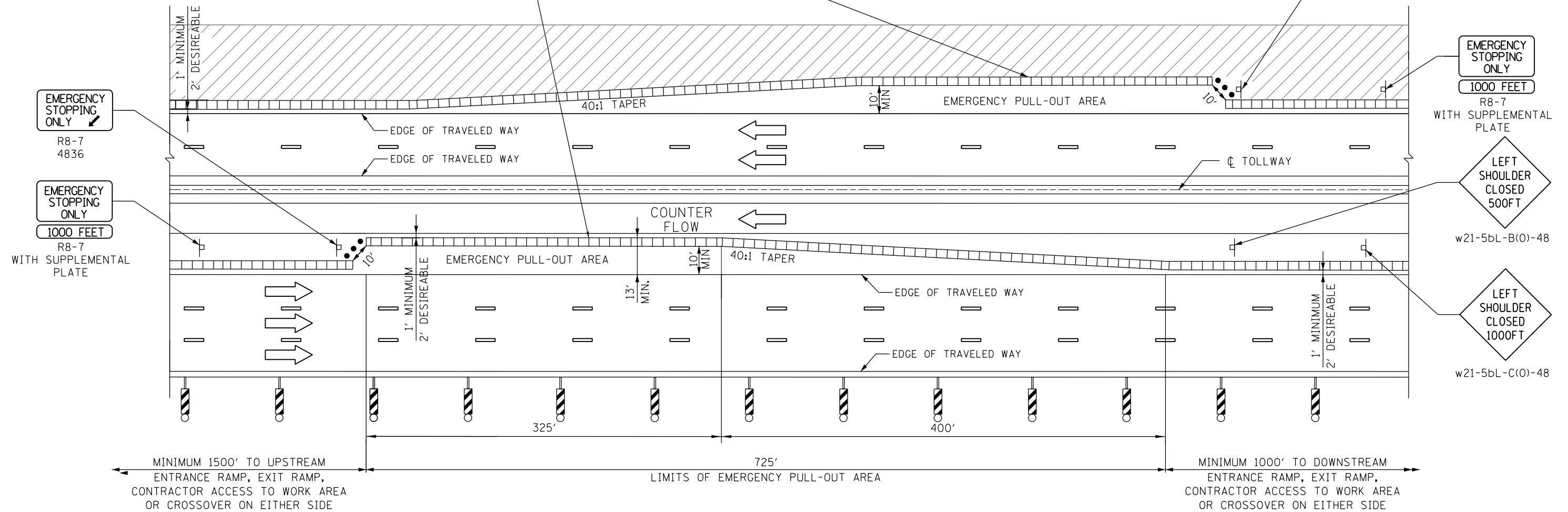

EMERGENCY PULL-OUT AREA

LEGEND

- TEMPORARY CONCRETE BARRIER WITH BARRIER DELINEATORS ON TRAFFIC SIDE AT 25' CENTERS
- VERTICAL PANELS WITH STEADY BURNING LIGHTS @ 100 FT CENTERS ALONG ROADWAY (TANGENT) AND 50 FT CENTERS ALONG TAPERS.
- WORK AREA
- FLEXIBLE DELINEATOR POSTS
- DIRECTION OF TRAFFIC FLOW
- CONSTRUCTION SIGN ON SUPPORT PER TOLLWAY STANDARD UNLESS NOTED.

NOTES:

1. EMERGENCY PULL-OUT AREA SPACED PER CONTRACT DOCUMENTS.
2. CONSTRUCTION MANAGER (CM) TO DETERMINE EMERGENCY ASSIST SIGN'S INFORMATION FOR DIRECTION-ROUTE SIGN-MILEPOST ONCE THE LOCATION HAS BEEN ACCEPTED.
3. A 1'-0" MINIMUM/2'-0" DESIRABLE SHY DISTANCE SHALL BE PROVIDED, MEASURED BETWEEN EDGE OF PAVEMENT LANE MARKING TO THE EDGE OF THE TRAFFIC CONTROL DEVICE.
4. FLEXIBLE DELINEATORS TO BE 48" IN HEIGHT ABOVE BASE, TUBULAR POSTS (ORANGE) WITH 360 DEGREES FULL VIEW TWO-4" FLOURESCENT ORANGE REFLECTORIZED TAPE BANDS. FLEXIBLE DELINEATORS SHALL BE CAPABLE OF BENDING UNDER REPEATED IMPACTS AND RETURN TO AN UPRIGHT POSITION WITHOUT DAMAGE TO THE IMPACTING VEHICLE OR THE DELINEATORS. THE DELINEATOR'S BASE SHALL BE SECURELY MOUNTED TO THE ROADWAY SURFACE. THE POSTS SHALL BE REMOVABLE FROM THE BASES TO PERMIT REPLACEMENT OF DAMAGED UNITS AS REQUIRED.

APPROVED: *Paul Kovacs* CHIEF ENGINEER DATE 2-7-2012

DATE	REVISIONS
11-1-2012	REVISED LENGTH OF PULL-OUT AREA REVISED NOTES

**Illinois Tollway**  
*Open Roads for a Faster Future*

EMERGENCY PULL-OUT AREA

STANDARD E7-01