



























# GENERAL NOTES - EROSION AND SEDIMENT CONTROLS

REVISIONS

1. THE WORK DESCRIBED ON THESE DRAWINGS ARE AN INTEGRAL PART OF THE STORM WATER POLLUTION PREVENTION PLAN USED TO OBTAIN A NPDES PERMIT FROM IEPA FOR THE CONSTRUCTION OF THIS PROJECT.
2. THE PURPOSE OF THE EROSION AND SEDIMENT CONTROL MEASURES INCLUDED FOR THIS PROJECT IS TO LIMIT THE SEDIMENT POLLUTION IMPACT OF ANY STORM WATER DISCHARGES THAT ORIGINATE ON THIS SITE OR OFF-SITE FLOWS THAT FLOW OVER THE DISTURBED AREAS.
3. IT IS THE RESPONSIBILITY OF THE CONTRACTOR TO ENSURE THAT SEDIMENT TRANSPORT OFF THE SITE IS REDUCED BY A COMBINATION OF MINIMIZATION OF EROSION AT THE SOURCE AND INSTALLATION OF SPECIFIC MEASURES TO CONTROL OR REDUCE THE TRANSPORT OF SEDIMENT. A COPY OF THE EROSION AND SEDIMENT CONTROL SCHEDULE BEING IMPLEMENTED BY THE CONTRACTOR SHALL BE ON THE CONSTRUCTION SITE AT ALL TIMES.
4. TO THE MAXIMUM EXTENT POSSIBLE, ALL FLOWS ORIGINATING OFF THE CONSTRUCTION SITE WILL BE DIVERTED AROUND DISTURBED AREAS OR WILL BE CONVEYED THROUGH THE SITE IN A MANNER THAT UNTREATED ON-SITE RUNOFF DOES NOT MIX WITH THE OFF-SITE RUNOFF.
5. ALL RUNOFF ORIGINATING ON DISTURBED AREAS ASSOCIATED WITH THIS PROJECT WILL PASS THROUGH ONE OR MORE MEASURES THAT WILL MINIMIZE THE OFF-SITE SEDIMENT IMPACTS OF THE CONSTRUCTION ACTIVITY.
6. ALL PERMANENT SEDIMENT BASINS, PERMANENT STORM WATER CONTROL MEASURES, AND RUNOFF CONTROL MEASURES REQUIRED TO KEEP OFF-SITE RUNOFF FROM FLOWING OVER THE CONSTRUCTION AREA WILL BE INSTALLED BEFORE CLEARING AND STRIPPING OF THE SITE PROCEEDS. PRIOR TO PROCEEDING WITH GENERAL EARTHWORK ON A PROJECT THE CONTRACTOR SHALL OBTAIN APPROVAL OF HIS PROPOSED EARTHWORK AND STABILIZATION SCHEDULE.
7. A MAXIMUM OF 20 ACRES IS ALLOWED TO BE IN SOME STAGE OF GRADING AT A SINGLE TIME. ADDITIONAL AREAS (UP TO 20 ACRES) MAY BE CLEARED BUT WILL NOT BE STRIPPED OF VEGETATION UNTIL THE GRADED AREAS HAVE BEEN PROTECTED FROM EROSION THROUGH INSTALLATION OF EITHER TEMPORARY OR PERMANENT MEASURES. WHENEVER POSSIBLE, THE GRADING WILL BE COMPLETED TO THE DESIGN GRADE AND THE PERMANENT VEGETATION PLAN IMPLEMENTED PRIOR TO STARTING GRADING ACTIVITIES ON THE NEXT SITE.
  - A. WHEN BALANCING EARTHWORK (BORROW FROM A CUT USED AS FILL AT A LOCATION DISTANT FROM THE CUT) THE CHIEF ENGINEER WILL CONSIDER ALLOWING MORE THAN 20 ACRES OF CONSTRUCTION WORK AREAS AND STORAGE AREAS.
  - B. WHERE NEW INTERCHANGES ARE BEING CONSTRUCTED THE ALLOWABLE AREA BEING GRADED MAY BE LARGER THAN 20 ACRES WHEN THE CONTRACT DRAWINGS DEFINE SUCH INCREASES.
  - C. VARIATIONS TO THE ABOVE MAY BE CONSIDERED BY THE CHIEF ENGINEER UNDER ALL THE FOLLOWING CONDITIONS:
    - IF THE CONTRACTOR FALLS BEHIND SCHEDULE THROUGH NO FAULT OF HIS OWN.
    - THE CONTRACTOR MUST PRESENT A SCHEDULE DEMONSTRATING THE NEED FOR SUCH VARIATION IN ORDER TO COMPLETE THE WORK ON TIME.
    - THE CONTRACTOR MUST COMPLY WITH ALL OTHER CONTRACT REQUIREMENTS.
8. DISTURBED AREAS ARE TO BE PROTECTED FROM EROSION IN A TIMELY MANNER. UPON COMPLETION OF GRADING OR CONSTRUCTION, THE AREA SHALL BE STABILIZED (USING PERMANENT MEASURES WHEN POSSIBLE) WITHIN 7 CALENDAR DAYS. TEMPORARY STABILIZATION THROUGH USE OF GROUND COVER, MULCHING, OR OTHER APPROVED MEASURES WILL BE INSTALLED WHENEVER SITE DEVELOPMENT WORK, GRADING OR OTHER EARTH DISTURBING ACTIVITIES CEASE TO BE CONTINUOUS FOR A PERIOD EXCEEDING 14 CALENDAR DAYS. THE 7/14 DAY REQUIREMENT IS TAKEN TO MEAN THAT THE STABILIZATION OPERATION IS COMPLETE OR NEARING COMPLETION IN THE DEFINED TIME.
9. STABILIZATION OF CUT OR FILL SLOPES WITH TEMPORARY OR PERMANENT EROSION CONTROL MEASURES IS REQUIRED WHENEVER THE CUT OR FILL ACTIVITY REACHES 15 FEET VERTICALLY OR THE FINISHED SLOPE EQUALS 50 FEET, WHICHEVER IS MORE RESTRICTIVE. ONCE THE STABILIZATION MEASURES ARE INSTALLED, THE PLACEMENT OF FILL OR EXCAVATION ACTIVITIES ARE ALLOWED TO PROCEED.
10. THE CONTRACTOR SHALL DESIGNATE ONE OF HIS EMPLOYEES AS EROSION AND SEDIMENT CONTROL MANAGER. THIS PERSON WILL BE RESPONSIBLE FOR IMPLEMENTATION OF THE EROSION AND SEDIMENT CONTROL PLAN ON ALL DISTURBED AREAS. THIS PERSON IS TO BE KNOWLEDGEABLE ABOUT INSTALLATION AND MAINTENANCE OF THE REQUIRED MEASURES. THIS EMPLOYEE IS TO HAVE THE AUTHORITY TO CARRY OUT THE IMPLEMENTATION OF ANY INSTRUCTIONS CONCERNING THE EROSION AND SEDIMENT CONTROL PLAN GIVEN BY THE ENGINEER. ALL MEASURES WILL BE INSPECTED BY THIS INDIVIDUAL AND THE ENGINEER ON A REGULAR BASIS (AT LEAST ONCE EVERY 7 DAYS) AND AFTER ANY RAINFALL EVENT GREATER THAN 0.5 INCHES, OR EQUIVALENT SNOWFALL (I.E. + 5")

11. SEDIMENT TRAPS, SEDIMENT BASINS, DITCHES, SILT FENCES, CHANNEL SILT FENCES, FENCES, STONE OUTLET STRUCTURES, EARTH BERMS, ETC. SHALL BE MAINTAINED DURING THE CONSTRUCTION SEASON AS WELL AS THE WINTER MONTHS AND OTHER TIMES WHEN THE PROJECT IS CLOSED DOWN. TRAPS WILL BE CLEANED WHEN THEY ARE 50% FILLED. SILT FENCE AND STONE OUTLET STRUCTURES SHALL HAVE SEDIMENT REMOVED WHEN IT REACHES 50% THE HEIGHT OF THE CONTROL DEVICE. THESE SPOILS WILL BE REMOVED TO AN APPROVED SITE.
12. SALVAGED TOPSOIL SHALL BE PLACED ON WELL DRAINED LAND AWAY FROM INTERMITTENT AND LIVE STREAMS OR WETLANDS WITH THE APPROPRIATE RUNOFF CONTROL AND SEDIMENT CONTROL MEASURES INSTALLED AROUND THE STORAGE SITE. SALVAGED TOPSOIL SHALL BE STABILIZED WITH STRAW MULCH IMMEDIATELY AFTER SHAPING OF THE PILE IN ACCORDANCE WITH THE STANDARD SPECIFICATIONS. SILT FENCE SHALL BE PROVIDED AT THE PERIMETER OF THE STOCKPILE.
13. MATERIALS EXCAVATED FOR THE CONSTRUCTION OR CLEAN OUT OF SEDIMENT TRAPS SHALL NOT BE STOCKPILED IN THE VICINITY OF THE TRAP. IT SHALL BE PLACED IN AN EMBANKMENT OR WASTED AS DIRECTED BY THE ENGINEER.
14. EXCAVATION TO BE USED FOR EMBANKMENTS SHALL NOT BE STOCKPILED UNLESS PERIMETER CONTROLS ARE UTILIZED. WHEN THIS MATERIAL IS STOCKPILED FOR THE CONVENIENCE OF THE CONTRACTOR THE COST OF PROVIDING THE CONTROLS ARE THE RESPONSIBILITY OF THE CONTRACTOR. IF THE MATERIAL IS STOCKPILED AT THE DIRECTION OF THE ENGINEER THE AUTHORITY WILL ASSUME THE COSTS OF THE CONTROLS.
15. SEDIMENT LADEN DEWATERING DISCHARGE MUST BE DIRECTED TO AN APPROVED SEDIMENT TRAPPING MEASURE PRIOR TO RELEASE FROM THE SITE.
16. ALL EROSION AND SEDIMENT CONTROL MEASURES ARE TO BE CONSIDERED TEMPORARY. THESE MEASURES WILL BE REMOVED BY THE CONTRACTOR UNLESS DESIGNATED PERMANENT ON THE PLANS OR AS DIRECTED BY THE ENGINEER.
17. WHEN THE CONTRACTOR REQUESTS A CHANGE TO POSTPONE COMPLETION OF THE EXCAVATION OF A SPECIFIC AREA AS A CONTINUOUS OPERATION AND PLACING THE TOPSOIL AS DEFINED IN THE STANDARD SPECIFICATIONS, THE ENGINEER MAY ALLOW THE CONTRACTOR TO STABILIZE THE AREA USING TEMPORARY STABILIZATION WITH STRAW MULCH PROVIDING THE FOLLOWING CONDITIONS ARE MET:
  - A. ALL AREAS BEING STABILIZED ARE 3:1 SLOPES OR FLATTER.
  - B. THE COST OF PREPARING THE SEED BED AND STABILIZING THE AREA WITH TEMPORARY STABILIZATION WITH STRAW MULCH IS THE RESPONSIBILITY OF THE CONTRACTOR.
  - C. ALL REQUIRED SEDIMENT CONTROL MEASURES FOR THE SECTION OF ROAD IN QUESTION HAVE BEEN INSTALLED AND ARE BEING MAINTAINED.
18. THE CONTRACTOR SHALL PREPARE A SKETCH SHOWING DIMENSIONS FROM TWO ADJACENT OBJECTS TO ALL DRAINAGE STRUCTURES THAT HAVE BEEN PROTECTED. THIS IS TO LOCATE THE STRUCTURE IN CASE OF HEAVY RAINFALL AND THE STRUCTURE IS BLOCKED OR FLOODED. THE CONSTRUCTION SECTION ENGINEER SHALL BE PROVIDED WITH A COPY OF THE SKETCH.
19. THE CONTRACTOR SHALL CONDUCT HIS OPERATIONS IN ACCORDANCE WITH THE STANDARD DRAWINGS AND SPECIAL PROVISION (S.P.) 111.2, STORM WATER POLLUTION PREVENTION PLAN INCLUDING CONTROLS AND SPILL PREVENTION - MATERIAL MANAGEMENT PRACTICES. THE CONTRACTOR SHALL SIGN THE CONTRACTOR'S GENTRIFICATION STATEMENT. LIST THE MATERIALS OR SUBSTANCES EXPECTED TO BE PRESENT ON-SITE IN THE INVENTORY FOR POLLUTION PREVENTION PLAN AND SHALL NAME TWO ADDITIONAL INDIVIDUALS TO ASSIST IN SPILL PREVENTION AND CLEAN UP AT THE PRECONSTRUCTION CONFERENCE. SEE S.P. 111.2.
20. AT THE TIME OF THE PRECONSTRUCTION CONFERENCE, THE CONTRACTOR SHALL SUBMIT FOR APPROVAL THE PROPOSED CONCRETE TRUCK WASHOUT LOCATIONS AS REQUIRED IN SPECIAL PROVISION 111. RUNOFF FROM WASH AREAS SHALL BE CONTAINED IN DESIGNATED AREAS SO THAT RUNOFF DOES NOT REACH THE STORM SEWER OR DITCH SYSTEMS.
21. IF AN ALTERNATIVE SIZE DITCH CHECK IS PROPOSED BY THE CONTRACTOR FOR USE ON THE PROJECT, A CONTRACT DITCH CHECK SPACING WILL NEED TO BE RECALCULATED FOLLOWING FIGURE 1-1 OF THE EROSION AND SEDIMENT CONTROL, LANDSCAPE DESIGN CRITERIA MANUAL. ANY RESULTING QUANTITY CHANGES SHALL BE DISCUSSED WITH ISTHA PRIOR TO RECEIVING APPROVAL.

## STANDARD SYMBOLS

- |   |  |
|---|--|
|    | AGGREGATE BERM                                     |
|    | CLEARING & GRADING LIMITS (LIMITS OF CONSTRUCTION) |
|    | CULVERT INLET PROTECTION-FENCE                     |
|    | CULVERT INLET PROTECTION-STONE                     |
|    | DIVERSION DIKE                                     |
|    | DEWATERING BASIN                                   |
|    | DRAINAGE DIVIDE                                    |
|    | EXISTING DRAINAGE PATH                             |
|    | FABRIC INLET PROTECTION                            |
|    | INITIAL CONSTRUCTION ITEM                          |
|    | PROPOSED DRAINAGE PATH                             |
|    | ROCK CHECK DAM                                     |
|    | ROLLED EXCELSIOR DITCH CHECK                       |
|   | RECTANGULAR INLET PROTECTION                       |
|  | STABILIZED CONSTRUCTION ENTRANCE                   |
|  | SILT FENCE   |
|  | SUPER SILT FENCE                                   |
|  | SEDIMENT BASIN                                     |
|  | STREAM DIVERSION                                   |
|  | STONE OUTLET STRUCTURE SEDIMENT TRAP               |
|  | TEMPORARY STREAM CROSSING                          |
|  | TEMPORARY RIPRAP                                   |
|  | TEMPORARY PIPE SLOPE DRAIN                         |
|  | TREE PROTECTION                                    |
|  | TEMPORARY SWALE                                    |
|  | URETHANE FOAM DITCH CHECK                          |

SHEET 1 OF 11

APPROVED  DATE 6-14-2006  
 CHIEF ENGINEER

**Illinois Tollway**  
*Open Roads for a Faster Future*

TEMPORARY EROSION AND SEDIMENT CONTROLS

DATE 05-12-2005 STANDARD NO. ESC 05-01

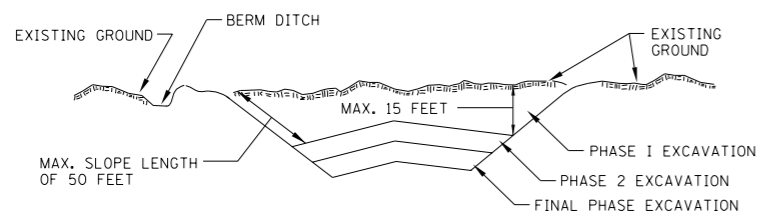

NOTES:

- ALL CUT SLOPES SHALL BE EXCAVATED AND STABILIZED (PLACE TOPSOIL PREPARE SEEDBED, APPLY SEED, PROTECT SLOPE WITH MULCH OR EROSION BLANKET) AS THE WORK PROGRESSES.
- CONSTRUCTION SEQUENCE:
  - EXCAVATE AND STABILIZE BERM, SIDE AND OUTLET DITCHES, PROVIDE SEDIMENT TRAPS FOR DITCHES.
  - PERFORM PHASE 1 EXCAVATION AND STABILIZE SLOPES WITH PERMANENT SEEDING.
  - PERFORM PHASE 2 EXCAVATION AND STABILIZE SLOPES WITH PERMANENT SEEDING, OVER SEED PHASE 1 SLOPES, IF REQUIRED.
  - PERFORM FINAL PHASE EXCAVATION, DRESS, SEED AND MULCH SLOPES WITH PERMANENT SEEDING, STABILIZE SURFACE DRAIN DITCHES, OVER SEED PHASE 1 & 2 SLOPES, IF REQUIRED, AS DETERMINED BY THE ENGINEER.
- IF PERMANENT SEEDING CANNOT BE PLACED DUE TO CONTRACT REQUIREMENTS REGARDING PLANTING SEASONS, THE CUT SLOPE IS TO HAVE TOPSOIL PLACED AND SEEDING PREPARED PRIOR TO USING TEMPORARY STABILIZATION WITH STRAW MULCH OR TEMPORARY SEEDING WITH EROSION BLANKET.
- THE CONTRACTOR HAS THE OPTION OF DELAYING TOPSOIL SEEDING BEYOND THE 15 FOOT LIMITATION. IF THIS OPTION IS CHOSEN, THE CUT SLOPE MUST BE "TEMPORARY STABILIZED" AT NO COST TO THE AUTHORITY.
- ONCE THE EXCAVATION WITHIN A SPECIFIC AREA HAS BEGUN, THE OPERATION SHALL BE CONTINUOUS FROM STRIPPING THROUGH THE COMPLETION OF THE GRADING AND PLACEMENT OF SLOPE STABILIZATION MEASURES. ANY INTERRUPTIONS IN THE OPERATION OF 14 DAYS OR MORE MUST BE APPROVED BY THE ENGINEER. ANY VIOLATION OF THIS REQUIREMENT WILL RESULT IN THE CONTRACTOR ASSUMING THE RESPONSIBILITY OF PLACING TEMPORARY STABILIZATION AT HIS OWN COST AND EXPENSE.

EXCAVATION PHASING PLAN - CUT SECTION

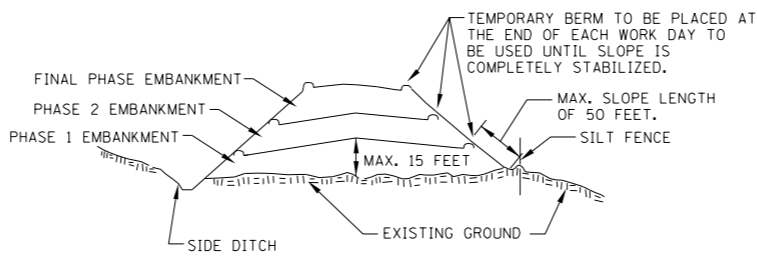

NOTES:

- THE EMBANKMENT WILL BE MADE IN STAGES NOT TO EXCEED 15 FEET IN HEIGHT OR 50 FEET IN SLOPE LENGTH. THE EMBANKMENT SLOPES WILL BE STABILIZED USING TEMPORARY MEASURES BEFORE BEGINNING NEXT STAGE.
- AT THE END OF EACH WORK DAY TEMPORARY BERMS (EARTH) AND TEMPORARY PIPE SLOPE DRAINS WILL BE CONSTRUCTED ALONG THE TOP EDGE(S) OF THE EMBANKMENT TO INTERCEPT SURFACE RUNOFF.
  - EXCAVATE AND STABILIZE SIDE DITCH AND/OR INSTALL PROPOSED PERIMETER CONTROLS AT THE TOE OF SLOPE.
  - PLACE PHASE 1 EMBANKMENT AND STABILIZE WITH TEMPORARY SEEDING AND MULCH.
  - PLACE PHASE 2 EMBANKMENT AND STABILIZE WITH TEMPORARY SEEDING AND MULCH.
  - PLACE FINAL PHASE EMBANKMENT AND STABILIZE WITH PERMANENT VEGETATIVE PLAN ON THE ENTIRE SLOPE.
- ONCE THE PLACEMENT OF FILL WITHIN A SPECIFIC AREA HAS BEGUN, THE OPERATION SHALL BE CONTINUOUS FROM STRIPPING THROUGH THE COMPLETION OF THE GRADING AND PLACEMENT OF PERMANENT VEGETATIVE PLAN. ANY INTERRUPTIONS IN THE OPERATION OF 14 DAYS OR MORE MUST BE APPROVED BY THE ENGINEER. ANY VIOLATION OF THIS REQUIREMENT WILL RESULT IN THE CONTRACTOR ASSUMING THE RESPONSIBILITY OF PLACING TEMPORARY STABILIZATION AT HIS OWN COST AND EXPENSE.

EMBANKMENT PHASING PLAN - FILL SECTION

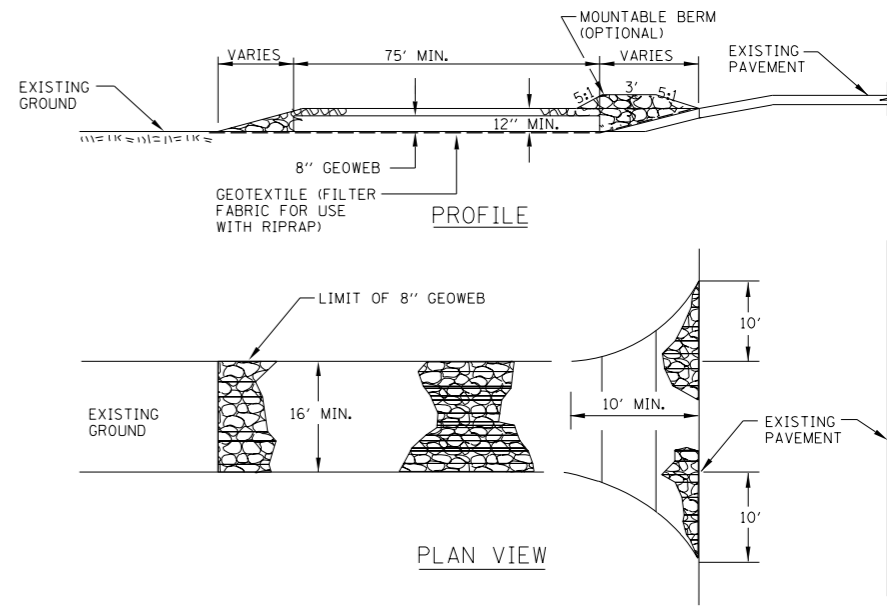

NOTES:

- STONE
    - STONE SIZE - CA-3
    - LENGTH - AS REQUIRED, BUT NOT LESS THAN 75 FEET.
    - THICKNESS - NOT LESS THAN 4" ABOVE TOP OF GEOWEB.
  - WIDTH - 16 FOOT MINIMUM FOR ONE WAY TRAFFIC; 24' MINIMUM FOR TWO WAY TRAFFIC; BUT NOT LESS THAN THE FULL WIDTH AT POINTS WHERE INGRESS OR EGRESS OCCURS.
  - GEOWEB NOT LESS THAN EIGHT (8) INCHES IN DEPTH WILL BE PLACED OVER THE ENTIRE AREA PRIOR TO PLACING OF STONE.
  - SURFACE WATER - ALL SURFACE WATER FLOWING OR DIVERTED TOWARD CONSTRUCTION ENTRANCES SHALL BE PIPED ACROSS THE ENTRANCE. IF PIPING IS IMPRACTICAL, A MOUNTABLE BERM WITH 5:1 SLOPES WILL BE PERMITTED.
  - MAINTENANCE - THE ENTRANCE SHALL BE MAINTAINED IN A CONDITION WHICH SHALL PREVENT TRACKING OR FLOWING OF SEDIMENT ONTO PUBLIC RIGHTS-OF-WAY. THIS MAY REQUIRE PERIODIC TOP DRESSING WITH ADDITIONAL STONE AS CONDITIONS DEMAND AND REPAIR AND/OR CLEAN OUT OF ANY MEASURES USED TO TRAP SEDIMENT. ALL SEDIMENT SPILLED, DROPPED, WASHED OR TRACKED ONTO PUBLIC RIGHTS-OF-WAY SHALL BE REMOVED IMMEDIATELY.
  - PERIODIC INSPECTION AND NEEDED MAINTENANCE SHALL BE PROVIDED AFTER HEAVY USE AND EACH RAINFALL EVENT.
- APPLICATION: TO BE USED TO REDUCE OR ELIMINATE TRACKING OF SEDIMENT ONTO PUBLIC STREETS. PLACE AT ALL POINTS OF CONSTRUCTION INGRESS AND EGRESS.

STABILIZED CONSTRUCTION ENTRANCE



APPROVED *Jeff Daley* CHIEF ENGINEER DATE 6-14-2006

**Illinois Tollway**  
Open Roads for a Faster Future

TEMPORARY EROSION AND SEDIMENT CONTROLS

DATE 05-12-2005 STANDARD NO. ESC 05-01

REVISIONS

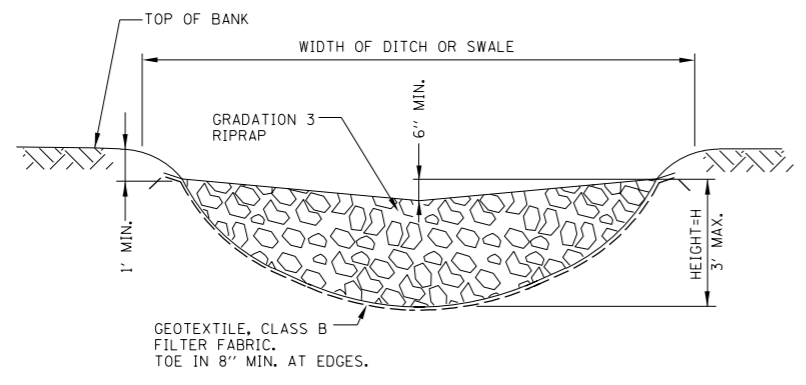
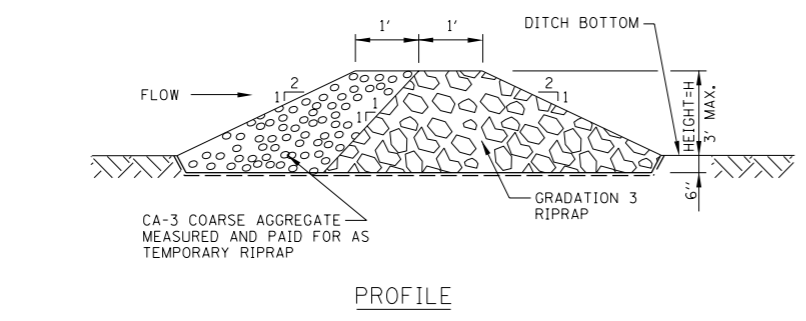

CROSS SECTION  
CENTERLINE LOOKING DOWNSTREAM

NOTES:

- FOR LOCATIONS AND HEIGHTS OF ROCK CHECK DAMS REFER TO CONSTRUCTION DRAWINGS.
- THE ROCK CHECK DAMS SHALL BE REPLACED WHEN THEY CEASE TO FUNCTION AS INTENDED DUE TO WASHOUT OR CONSTRUCTION TRAFFIC DAMAGE.
- THE ROCK CHECK DAMS SHALL BE REMOVED WHEN CONSTRUCTION IS COMPLETE SO AS NOT TO BLOCK OR IMPEDE STORM FLOW OR DRAINAGE UNLESS DIRECTED OTHERWISE BY THE ENGINEER.
- SEDIMENT SHALL BE REMOVED WHEN IT REACHES 50% OF DAM HEIGHT. THIS PRACTICE IS NOT A SUBSTITUTE FOR MAJOR PERIMETER TRAPPING SUCH AS A TEMPORARY SEDIMENT TRAP OR BASIN.

APPLICATION: USE IN EXISTING, PROPOSED AND TEMPORARY DITCHES OF ALL TYPES AS SHOWN ON PLANS OR AS DIRECTED BY THE ENGINEER. USE WHERE VELOCITY EXCEEDS 8 FEET PER SECOND. MAXIMUM DRAINAGE AREA TO EACH DAM IS 10 ACRES.

TEMPORARY ROCK CHECK DAM

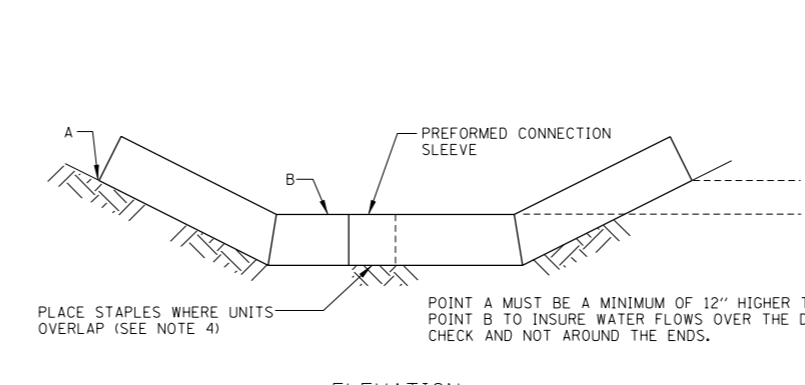
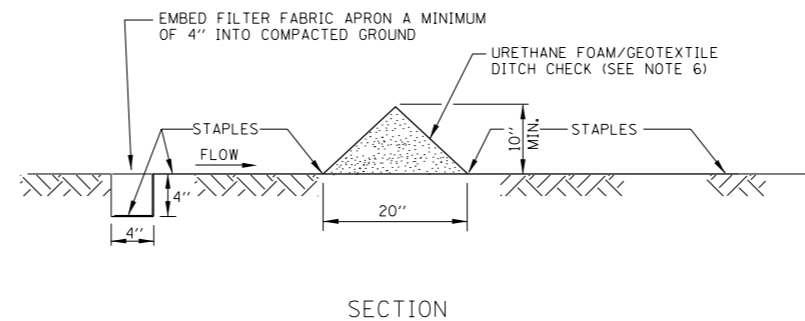
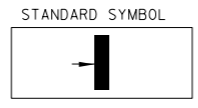

ELEVATION

NOTES:

- UPSTREAM EDGE OF DITCH CHECK APRON TO BE PLACED IN A 4"x4" TRENCH AND ANCHORED WITH A ROW OF WIRE STAPLES ON 18" CENTERS TO ASSURE THAT STORM WATER IS FORCED THROUGH THE DITCH CHECK RATHER THAN UNDER IT.
- BUTT ENDS OF DITCH CHECKS TOGETHER USING PREFORMED CONNECTION SLEEVE ATTACHED TO DITCH CHECK.
- PLACE WIRE STAPLES IN PATTERN AS SPECIFIED BY THE MANUFACTURER WITH A MINIMUM OF 8 STAPLES PER SQUARE YARD OF APRON. WIRE STAPLES TO BE A MINIMUM OF NO. 11 GAUGE, 8" LONG.
- URETHANE FOAM/GEOTEXTILE DITCH CHECKS ARE SUPPLIED IN STANDARD 7 FOOT LENGTHS AND SHOULD NOT BE CUT. THE DSE SHALL LIST THE QUANTITIES IN MULTIPLES OF SEVEN FEET.
- MAINTENANCE SHALL BE PERFORMED AS NEEDED AND SILT SHALL BE REMOVED WHEN IT REACHES 50% OF DITCH CHECK HEIGHT.
- FOR ALTERNATE SIZE DITCH CHECK SEE GENERAL NOTE 21 ON SHEET 1 (OF 11) IN THIS SERIES.

APPLICATION: URETHANE FOAM/GEOTEXTILE DITCH CHECK TO BE USED TO CONTROL FLOW IN DITCHES THAT HAVE A VELOCITY OF LESS THAN 8 FEET PER SECOND. MAXIMUM DRAINAGE AREA SHALL NOT EXCEED 1/2 ACRE.

THE DITCH CHECK IS NOT A SUBSTITUTE FOR SEDIMENT TRAPS OR BASINS. PLACE UPSTREAM OF TRAPS OR BASINS AND MAINTAIN IN PLACE UNTIL SEEDING IS ESTABLISHED.

TEMPORARY DITCH CHECK  
URETHANE FOAM/GEOTEXTILE

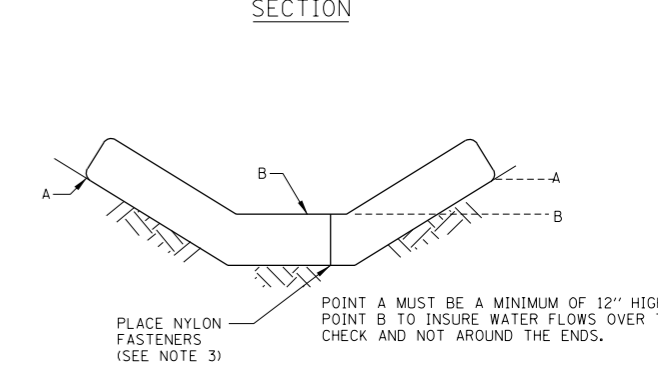
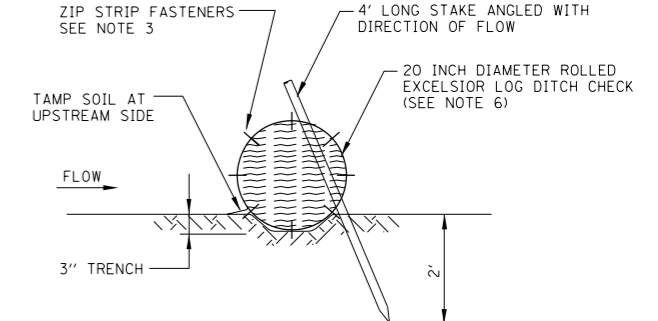
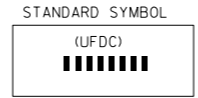

ELEVATION

NOTES:

- ROLLED EXCELSIOR LOG SHALL BE EMBEDDED IN THE SOIL A MINIMUM OF 3" AND SOIL SHALL BE TAMPED AGAINST THE UPSTREAM SIDE TO ASSURE THAT STORM WATER IS FORCED THROUGH THE LOG, RATHER THAN UNDER IT.
- STAKES SHALL BE 4' LONG, DRIVEN AT A SPACING OF 2' ON CENTER, 2' INTO THE GROUND. STAKES SHALL BE ENTWINED WITH THE MESH COVERING OF THE ROLL ON THE DOWNSTREAM SIDE AND ANGLED WITH THE DIRECTION OF FLOW. WOOD STAKES TO BE A MINIMUM OF 1" SQUARE. METAL STAKES SHALL BE A MINIMUM OF 1" DIAMETER.
- WHEN MORE THAN ONE LOG IS REQUIRED TO SPAN THE DITCH, BUTT LOGS TIGHTLY TOGETHER END TO END AND FASTEN TOGETHER WITH A MINIMUM OF EIGHT EQUALLY SPACED ZIP STRIP NYLON FASTENERS.
- ROLLED EXCELSIOR LOG DITCH CHECKS ARE SUPPLIED IN STANDARD 10 FOOT LENGTHS AND SHOULD NOT BE CUT. THE DSE SHALL LIST THE QUANTITIES IN MULTIPLES OF TEN FEET.
- MAINTENANCE SHALL BE PERFORMED AS NEEDED AND SILT SHALL BE REMOVED WHEN IT REACHES 50% OF ROLL HEIGHT.
- FOR ALTERNATE SIZE DITCH CHECK SEE GENERAL NOTE 21 ON SHEET 1 (OF 12) IN THIS SERIES.

APPLICATION: ROLLED EXCELSIOR LOG IS TO BE USED TO CONTROL FLOW IN DITCHES THAT HAVE A VELOCITY OF LESS THAN 8 FEET PER SECOND. MAXIMUM DRAINAGE AREA SHALL NOT EXCEED 1/2 ACRE.

THE DITCH CHECK IS NOT A SUBSTITUTE FOR SEDIMENT TRAPS OR BASINS. PLACE UPSTREAM OF TRAPS OR BASINS AND MAINTAIN IN PLACE UNTIL SEEDING IS ESTABLISHED.

TEMPORARY DITCH CHECK  
ROLLED EXCELSIOR LOG

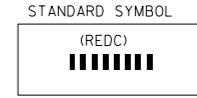

APPROVED: *Jeff Stanley*  
CHIEF ENGINEER  
DATE: 6-14-2006

**Illinois Tollway**  
*Open Roads for a Faster Future*

TEMPORARY EROSION  
AND SEDIMENT CONTROLS

DATE: 05-12-2005  
STANDARD NO.: ESC 05-01

REVISIONS

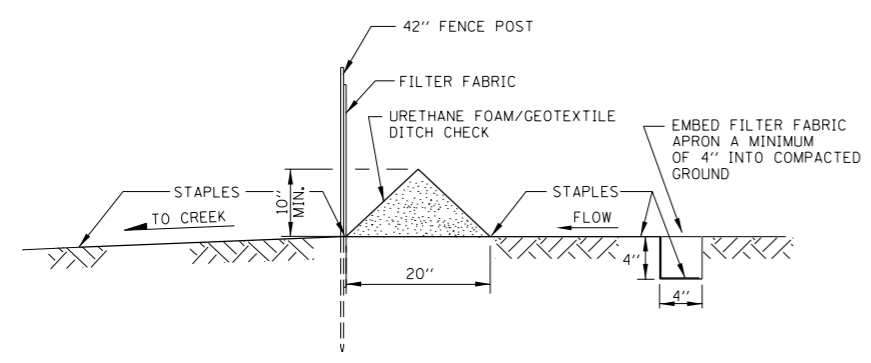

SECTION A-A

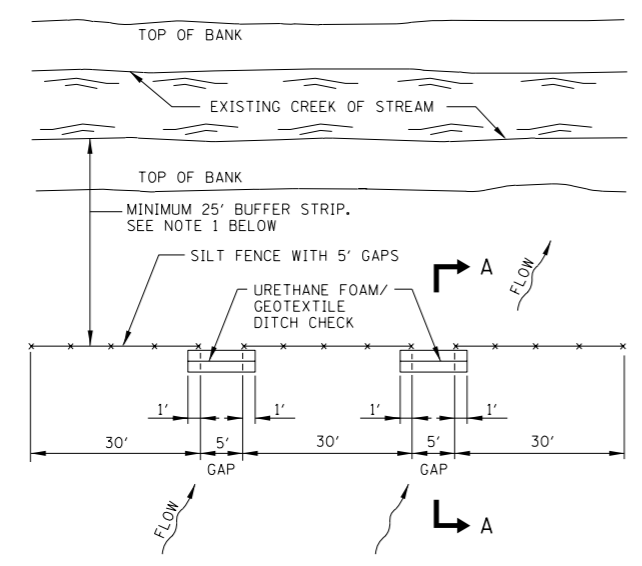

PLAN

NOTES:

1. A MINIMUM 25' WIDE VEGETATED BUFFER STRIP SHALL BE PRESERVED AND/OR RE-ESTABLISHED WHERE POSSIBLE ALONG EXISTING CHANNELS. THIS REQUIREMENT SHALL BE VERIFIED WITH THE LOCAL APPROVING AGENCY BY THE DSE AND THE PLANS ADJUSTED IF NECESSARY. ANY VARIATION IN THE 25' DIMENSION SHALL BE NOTED ON THE PLANS.
  2. THE 5' GAPS IN THE SILT FENCE AND THE 10" TEMPORARY DITCH CHECKS ARE TO ALLOW FLOODWATER FLOW INTO THE CREEK FROM THE SITE WITHOUT DAMAGE TO THE SILT FENCE.
- APPLICATION: CREEK BUFFER STRIP AND SILT FENCE WITH 5' GAPS TO BE USED AT EXISTING CREEKS OR STREAMS.

CREEK BUFFER STRIP AND SILT FENCE

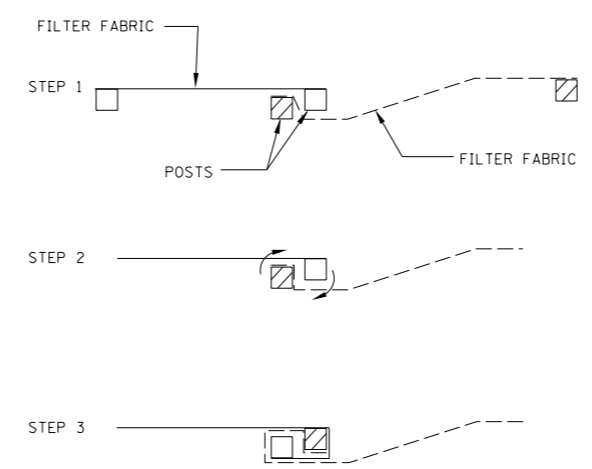

NOTES:

1. PLACE THE END POST OF THE SECOND FENCE INSIDE THE END POST OF THE FIRST FENCE.
2. ROTATE BOTH POSTS AT LEAST 180 DEGREES IN A CLOCKWISE DIRECTION TO CREATE A TIGHT SEAL WITH THE FABRIC MATERIAL.
3. DRIVE BOTH POSTS A MINIMUM OF 18 INCHES INTO THE GROUND AND BURY THE FLAP.

ATTACHING TWO SILT FENCES

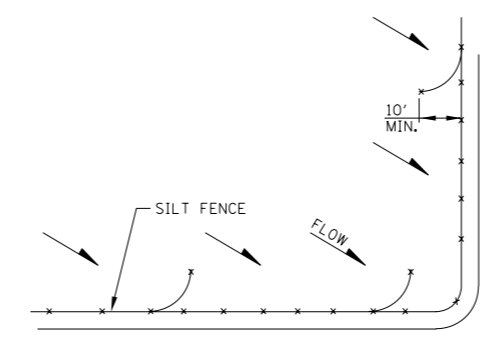

NOTES:

1. INSTALL SILT FENCE WITH "J" HOOKS AT APPROXIMATELY 200' INTERVALS TO INCREASE SILT FENCE EFFICIENCY.

SILT FENCE PLACEMENT

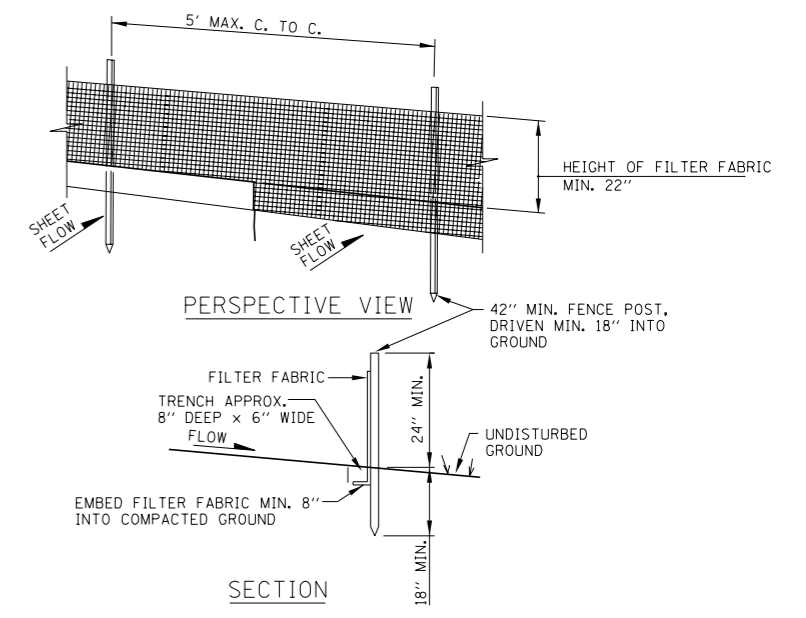

NOTES:

1. FILTER FABRIC TO BE FASTENED SECURELY TO FENCE POSTS.
  2. WHEN TWO SECTIONS OF FILTER FABRIC ADJOIN EACH OTHER THEY SHALL BE SECURELY FASTENED PER THE DETAIL AT LEFT.
  3. MAINTENANCE SHALL BE PERFORMED AS NEEDED. SILT BUILD UP AGAINST FENCE SHALL BE INSPECTED AFTER EVERY STORM EVENT AND REMOVED WHEN "BULGES" DEVELOP IN THE SILT FENCE, OR WHEN SILT REACHES 50% OF FENCE HEIGHT.
  4. FENCE POSTS: 2"x2" HARDWOOD OR SCHEDULE 40 METAL PIPE OR 1.33 LB/FT MIN. STANDARD T OR U SECTION STEEL.
  5. FILTER FABRIC SHALL CONFORM TO THE STANDARD SPECIFICATIONS FOR USE AS SILT FENCE.
- APPLICATION: THIS DEVICE IS TO CONTROL SHEET FLOW ONLY. DO NOT USE FOR CONCENTRATED FLOWS, DRAINAGE CHANNELS, ABOVE OR BELOW DRAINAGE PIPES. MAXIMUM DRAINAGE AREA FOR SHEET FLOW SHALL NOT EXCEED 1/2 ACRE PER 100 FEET OF SILT FENCE.

SILT FENCE (SF)

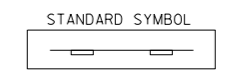

TEMPORARY EROSION AND SEDIMENT CONTROLS

DATE: 05-12-2005 STANDARD NO.: ESC 05-01

APPROVED: *Jeff Daley* CHIEF ENGINEER DATE: 6-14-2006

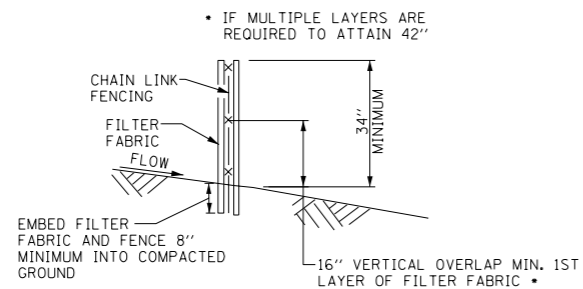

SECTION A-A

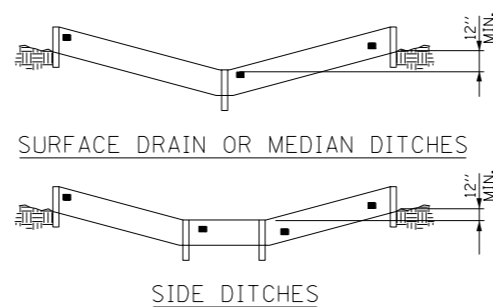

SURFACE DRAIN OR MEDIAN DITCHES

SIDE DITCHES

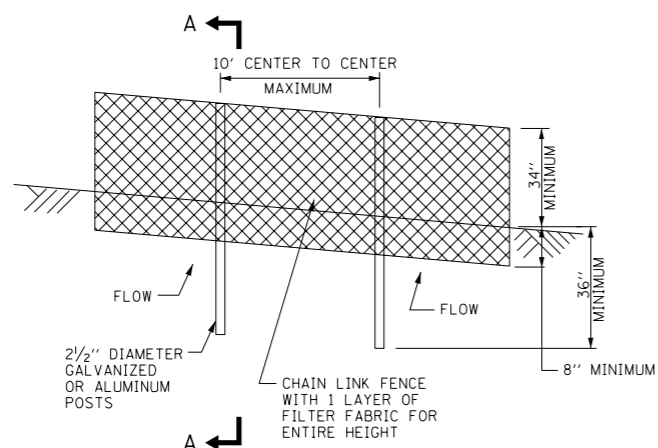

SUPER SILT FENCE (SSF)

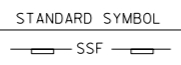

NOTES:

1. FENCING SHALL BE 42" IN HEIGHT AND CONSTRUCTED IN ACCORDANCE WITH IDOT STANDARD 664001 (CHAIN LINK FENCE). THE SPECIFICATION FOR A 6' FENCE SHALL BE USED, SUBSTITUTING 42" FABRIC AND 6' LENGTH POSTS.
2. CHAIN LINK FENCE SHALL BE FASTENED SECURELY TO THE FENCE POSTS WITH WIRE TIES. THE LOWER TENSION WIRE, BRACE AND TRUSS RODS, DRIVE ANCHORS AND POST CAPS ARE NOT REQUIRED. ALL POSTS FOR SUPER SILT FENCE SHALL BE LINE POSTS. PULL POSTS, CORNER POSTS, HORIZONTAL BRACING AND TIE RODS ARE NOT REQUIRED.
3. FILTER FABRIC SHALL BE FASTENED SECURELY TO THE CHAIN LINK FENCE WITH TIES SPACED EVERY 24" AT THE TOP AND MID SECTION.
4. FILTER FABRIC AND CHAIN LINK FENCE SHALL BE EMBEDDED 8" INTO THE GROUND.
5. WHEN TWO SECTIONS OF FILTER FABRIC ADJOIN EACH OTHER, THEY SHALL BE OVERLAPPED 2' HORIZONTALLY.
6. MAINTENANCE SHALL BE PERFORMED AS NEEDED. SILT BUILD-UP AGAINST FENCE SHALL BE INSPECTED AFTER EVERY STORM EVENT AND REMOVED WHEN SILT REACHES 50% OF FENCE HEIGHT.
7. FILTER FABRIC SHALL CONFORM TO THE STANDARD SPECIFICATIONS FOR USE AS SILT FENCE.
8. POST LENGTHS FOR SUPER SILT FENCE USED TO PROTECT ENVIRONMENTALLY SENSITIVE AREAS MAY NEED TO BE LONGER THAN 6 FEET. REFER TO PLANS FOR DETAILS.

APPLICATIONS: SUPER SILT FENCE IS TO BE USED TO PROTECT ENVIRONMENTALLY SENSITIVE AREAS AND TO CONTROL FLOW IN DITCHES ONLY IF OTHER DITCH CHECKS ARE NOT APPLICABLE AND INCREASED CONTAINMENT IS DESIRABLE. MAXIMUM DRAINAGE AREA SHALL NOT EXCEED 1/2 ACRE PER EACH DITCH CHECK.

WHEN SUPER SILT FENCE IS USED TO CONTROL CONCENTRATED SHEET FLOW, THE MAXIMUM DRAINAGE AREA SHALL NOT EXCEED 1/2 ACRE PER 100 FEET OF FENCE.

APPROVED: *Jeff Harley*  
 CHIEF ENGINEER  
 DATE: 6-14-2006

**Illinois Tollway**  
*Open Roads for a Faster Future*

TEMPORARY EROSION  
 AND SEDIMENT CONTROLS

DATE: 05-12-2005  
 STANDARD NO.: ESC 05-01

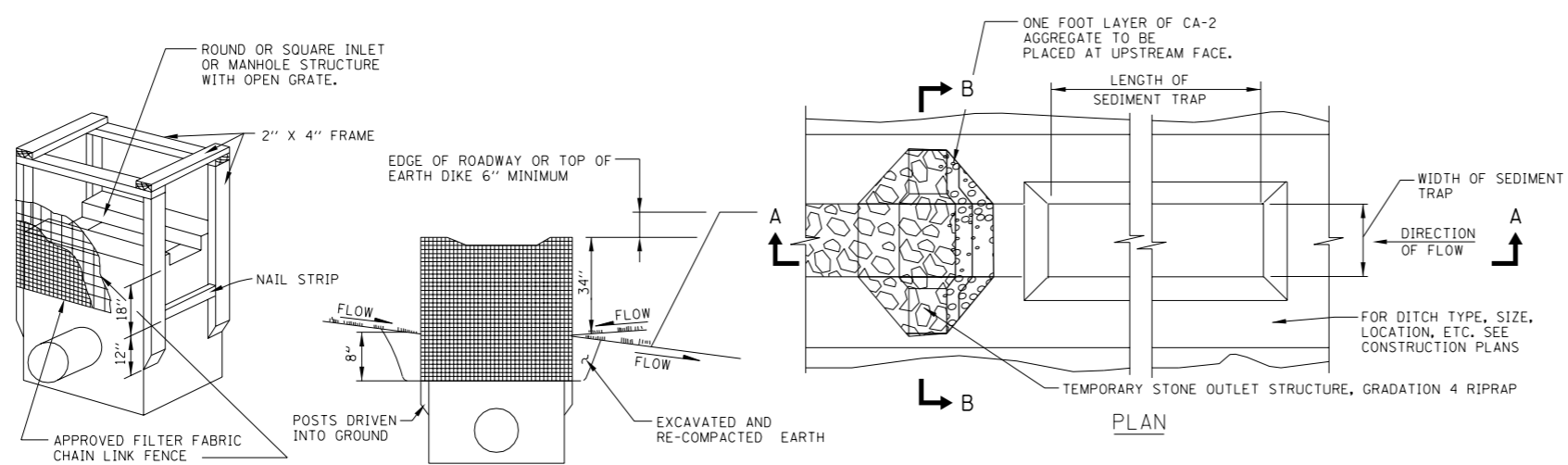

**NOTES:**

1. WOODEN FRAME IS TO BE CONSTRUCTED OF 2"x4" CONSTRUCTION GRADE LUMBER. IF CONTRACTOR PREFERENCES, SUPER SILT FENCE CAN BE CONSTRUCTED AROUND THE INLET PER SHEET 5 (OF 12) IN THIS SERIES.
2. MAINTENANCE SHALL BE PERFORMED AS NEEDED AND SILT REMOVED WHEN IT REACHES 50% OF FENCE HEIGHT.

APPLICATION: TO BE USED TO PROTECT EXISTING AND NEW INLETS, PAVED AREAS, CATCH BASINS AND MANHOLES WITH OPEN LIDS IN NON

**RECTANGULAR INLET PROTECTION**

STANDARD SYMBOL



**NOTES:**

1. USE IN EXISTING, PROPOSED AND TEMPORARY DITCHES OF ALL TYPES AS SHOWN ON PLANS OR AS DIRECTED BY THE ENGINEER.
2. THE STONE OUTLET STRUCTURES SHALL BE REPLACED DUE TO WASHOUT, CONSTRUCTION TRAFFIC DAMAGE OR SILT ACCUMULATION. THE SILT SHALL BE CLEANED OUT WHEN WET STORAGE PORTION OF TRAP IS 50% FULL.
3. STONE OUTLET STRUCTURE AND SEDIMENT TRAP SHALL BE REMOVED WHEN CONSTRUCTION IS COMPLETE SO AS NOT TO BLOCK OR IMPEDE STORM FLOW OR DRAINAGE. FILL SEDIMENT TRAP WITH COMPACTED CLAY EMBANKMENT MATERIAL, ZONE A.
4. A ONE FOOT LAYER OF CA-2 AGGREGATE WILL BE PLACED AGAINST THE UPSTREAM FACE OF THE TEMPORARY STONE OUTLET STRUCTURE, AND WILL BE MEASURED AND PAID FOR AS TEMPORARY RIPRAP.
5. THE DETENTION STORAGE SHALL BE COMPOSED OF EQUAL VOLUMES OF "WET" AND "DRY" STORAGE. THE WET AND DRY STORAGE AREAS SHALL EACH (BOTH) BE SIZED FOR THE RUNOFF FROM EITHER A 2-YEAR FREQUENCY, 24-HOUR DURATION STORM FROM THE AREA DRAINING INTO THE BASIN UNDER MAXIMUM RUNOFF CONDITIONS DURING CONSTRUCTION, OR 3,600 CUBIC FEET/ ACRE BASED ON THE AREA DRAINING INTO THE BASIN, WHICHEVER IS GREATER. HALF THE DETENTION STORAGE SHALL BE BELOW THE PERMEABLE FILL.
6. THE MAXIMUM DRAINAGE AREA ALLOWED PER TRAP IS 5 ACRES INCLUDING BOTH ON-SITE AND OFF-SITE TRIBUTARY AREAS. IF DRAINAGE AREA IS OVER 5 ACRES, USE A SEDIMENT BASIN, OR SEDIMENT TRAPS MAY BE PLACED IN SERIES.

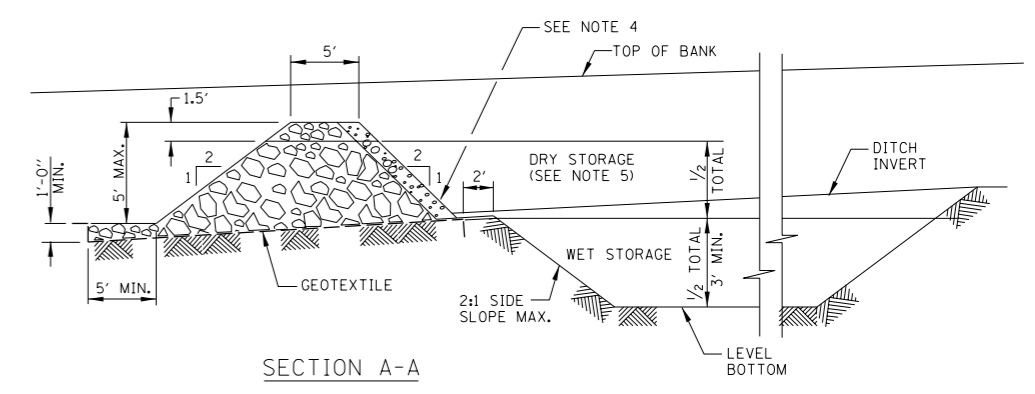

SECTION A-A

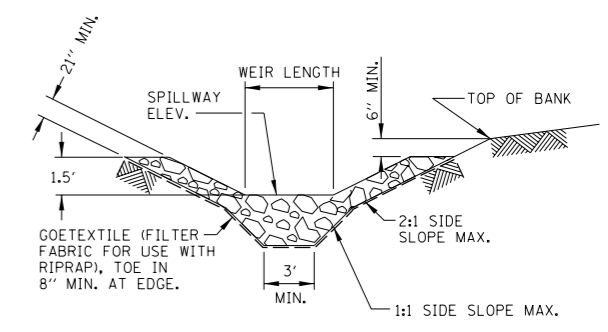

SECTION B-B

SEDIMENT TRAP WEIR	
DRAINAGE AREA (ACRES)	WEIR LENGTH (FEET) MIN.
1	4
2	6
3	8
4	10
5	12

**STONE OUTLET STRUCTURE SEDIMENT TRAP**

STANDARD SYMBOL



TEMPORARY EROSION AND SEDIMENT CONTROLS

DATE 05-12-2005 STANDARD NO. ESC 05-01

APPROVED *Jeff Haley* CHIEF ENGINEER DATE 6-14-2006

REVISIONS

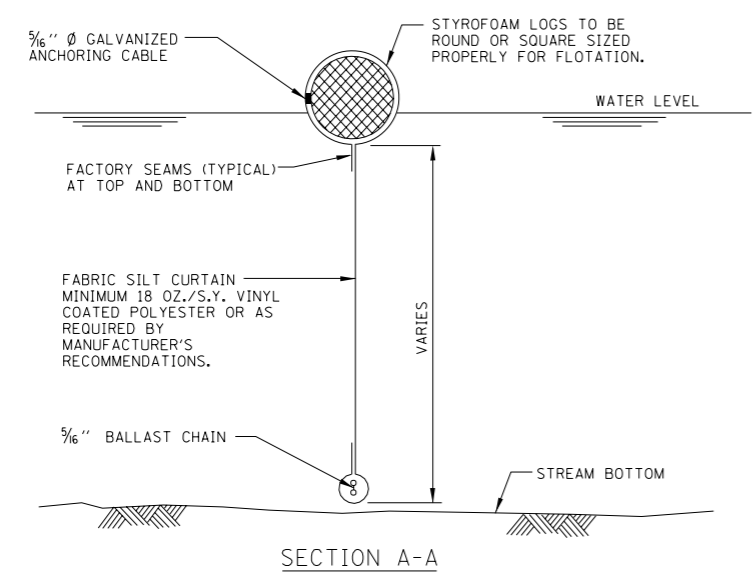
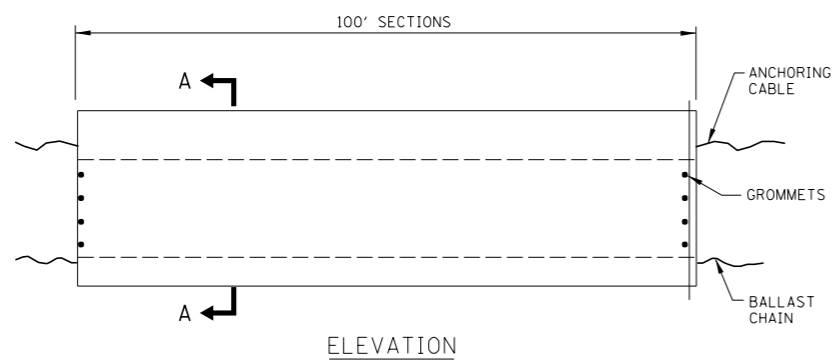

**NOTES:**

1. FLOTATION BOOM SHALL BE ANCHORED TO PREVENT DRIFT SHOREWARD OR DOWNSTREAM. ANCHORAGES SHALL BE INSTALLED ON BOTH SHORE AND STREAM SIDE. BOOMS ARE NOT TO BE INSTALLED ACROSS FLOWING BODY OF WATER.
2. SHORE ANCHORS SHALL CONSIST OF A POST WITH DEADMAN OR APPROVED EQUAL. STREAM ANCHORS SHALL BE OF SUFFICIENT SIZE TO STABILIZE THE BARRIER WITH NUMBER AND SPACING DEPENDENT ON WATERWAY VELOCITIES.
3. FABRIC SECTIONS SHALL BE CONNECTED END TO END WITH MINIMUM 5/8" DIAMETER POLYPROPYLENE ROPE.
4. DESIGN OF BOOM AND ANCHORAGE SHALL BE IN ACCORDANCE WITH MANUFACTURER'S RECOMMENDATIONS. BOTTOM OF BOOM SHALL REACH BOTTOM OF WATERWAY USING ONE OR TWO VERTICAL SECTIONS AS REQUIRED.
5. MAINTENANCE SHALL BE PERFORMED AS NEEDED. CONTRACTOR SHALL REMOVE THE BOOM AT COMPLETION OF WORK IN A MANNER THAT WILL PREVENT SILTATION OF THE WATERWAY.

APPLICATION: FLOTATION BOOMS TO BE USED TO CONTROL TURBIDITY AND DEBRIS WHEN WORKING IN WATERWAYS.

**FLOTATION BOOM**

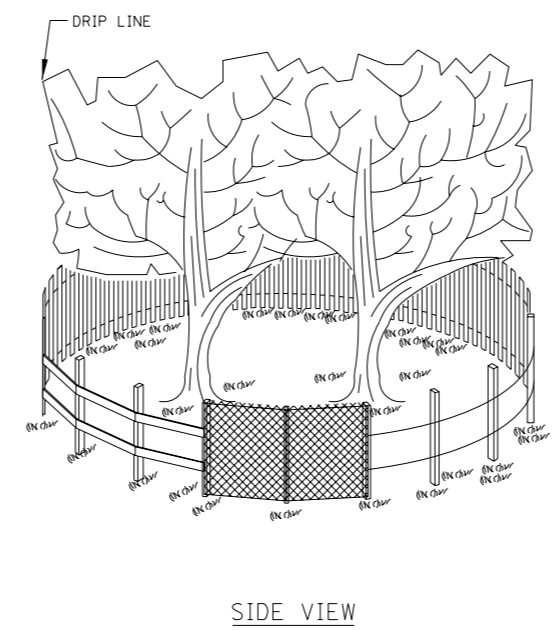
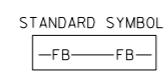

**NOTES:**

1. THE FENCE SHALL BE LOCATED OUTSIDE THE DRIP LINE OF THE TREE TO BE SAVED AND IN NO CASE CLOSER THAN 5 FEET TO THE TRUNK OF ANY TREE.
  2. CONTRACTOR SHALL USE SILT FENCE, ORANGE PLASTIC FENCE, OR WOOD LATH SNOW FENCE TO PROTECT THE AREA.
- APPLICATION: TO BE USED TO PROTECT TREES FROM DISTURBANCE AND FROM EQUIPMENT TRAVELING OVER THE ROOT ZONE.

**TREE PROTECTION**

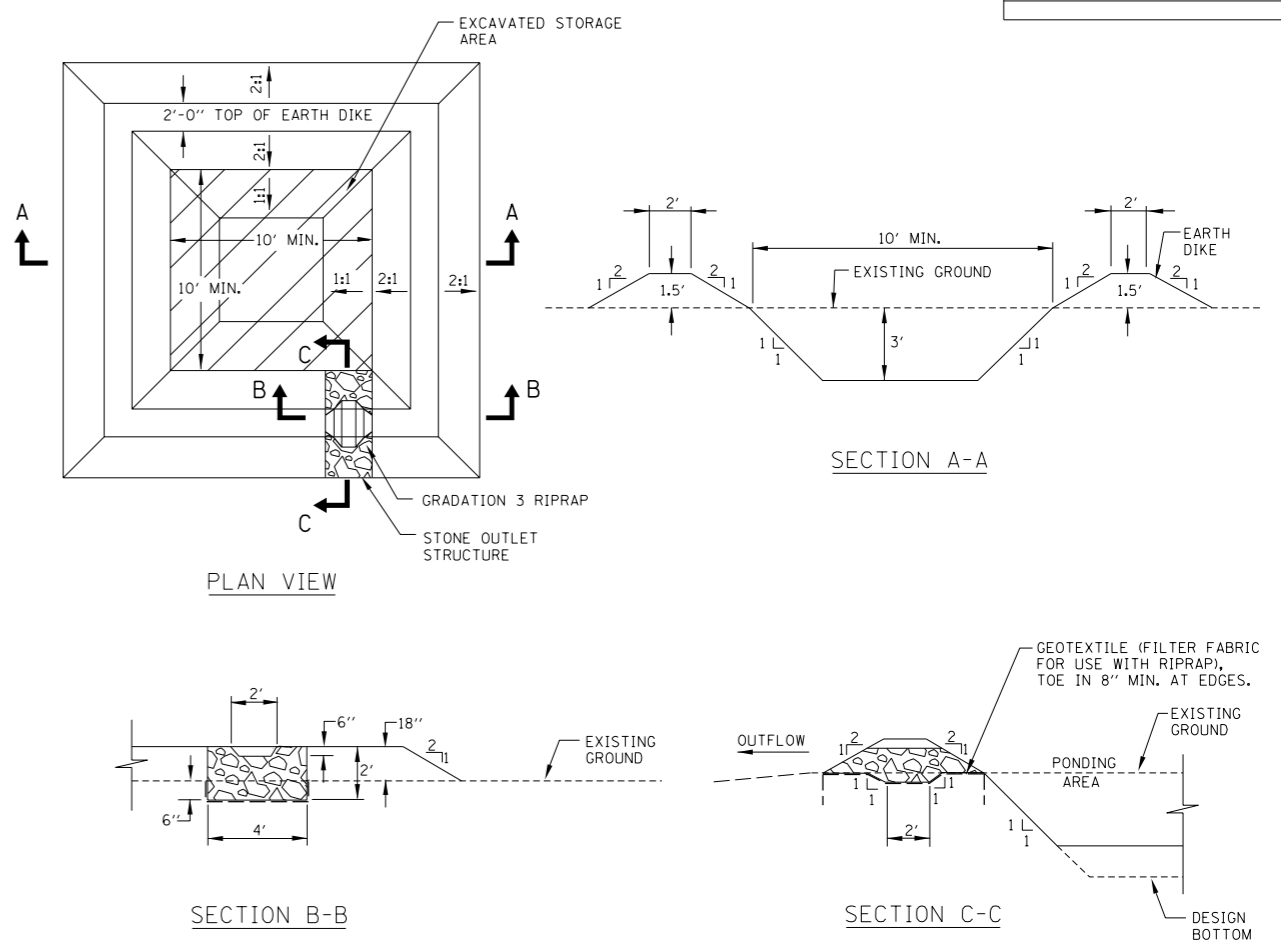
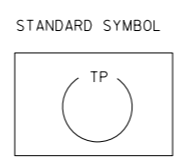

**NOTES:**

1. ANY DEWATERING OF THE CONSTRUCTION AREA SHALL BE FILTERED THROUGH A DEWATERING BASIN PRIOR TO ENTERING RECEIVING WATERS.
2. PUMPING INTO THESE BASINS SHALL CEASE WHEN THE EFFLUENT FROM THE BASIN BECOMES SEDIMENT LADEN. THE BASIN MAY BE BYPASSED IF THE WATER BEING PUMPED IS NON SEDIMENT LADEN AND THERE IS A STABILIZED OUTFALL. SURFACE FLOWS SHALL BE DIVERTED AROUND THIS DEVICE.
3. THE DEWATERING BASIN SHALL BE EXCAVATED TO A MINIMUM DEPTH OF 3 FEET WITH A FLAT BOTTOM.
4. ONCE THE DEWATERING BASIN BECOMES FILLED TO 1/2 OF THE EXCAVATED DEPTH, ACCUMULATED SEDIMENT SHALL BE REMOVED.
5. THE OUTFALL FROM THE BASIN(S) SHALL HAVE A STABILIZED CONVEYANCE TO RECEIVING WATERS.
6. THE MINIMUM STORAGE CAPACITY OF THE DEWATERING BASIN IN CUBIC FEET SHALL BE THE DEWATERING PUMP CAPACITY IN GALLONS PER MINUTE TIMES 32.

APPLICATION: INSTALL DEWATERING BASIN WHENEVER WATER IS BEING REMOVED FROM THE CONSTRUCTION SITE AND THE WATER IS NOT BEING ROUTED THROUGH AN ADEQUATE SIZED SEDIMENT DEVICE.

**DEWATERING BASINS**

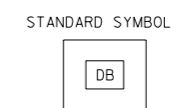

APPROVED: *Jeff Daley*  
 CHIEF ENGINEER  
 DATE: 6-14-2006

**Illinois Tollway**  
*Open Roads for a Faster Future*

TEMPORARY EROSION AND SEDIMENT CONTROL

DATE: 05-12-2005  
 STANDARD NO.: ESC 05-01

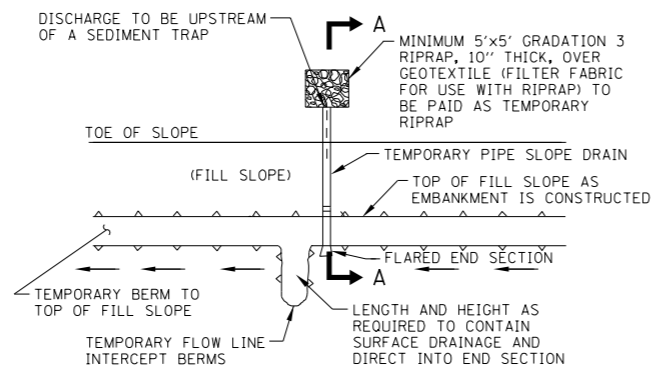
PLAN

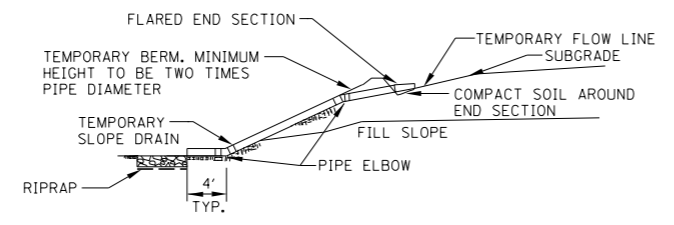

SECTION A-A  
FOR FILL SLOPES

NOTES:

1. THE CONTRACTOR SHALL PLACE GEOTEXTILE (FILTER FABRIC FOR USE WITH RIPRAP) AROUND THE END SECTION TO PREVENT BLOW-OUTS.
2. ALL TEMPORARY SLOPE DRAINS WILL DISCHARGE INTO THE BACK OF SEDIMENT TRAPS, INTO SEDIMENT BASINS OR DITCHES DISCHARGING INTO TRAPS OR BASINS.
3. PIPE SHALL BE INSTALLED WITH WATER TIGHT CONNECTING BANDS AND SHALL BE SECURELY ANCHORED BY HOLD DOWN STAKES AND CABLES AT A MAXIMUM SPACING OF 10 FEET.
4. TEMPORARY PIPE SLOPE DRAINS WILL BE SPACED A MAX. OF EVERY 500 FEET ALONG THE FILL WITH A STANDARD DIA. OF 18 INCHES. THIS SIZE PIPE IS ADEQUATE TO HANDLE 1.5 ACRES OF CONTRIBUTING AREA. SPACING OR SIZE IS TO BE ADJUSTED IF CONTRIBUTING AREA IS LARGER THAN 1.5 ACRES, SEE ILLINOIS URBAN MANUAL. AT LEAST TWO TEMPORARY PIPE SLOPE DRAINS WILL BE PLACED IN EVERY SAG.
5. STAPLES SHALL BE USED TO ANCHOR THE FILTER FABRIC AND SHALL BE UNIFORMLY SPACED AT APPROXIMATELY 12".

APPLICATION: TEMPORARY SLOPE DRAIN SHALL BE USED AT THE TOP OF FILL SLOPE AS EMBANKMENT IS CONSTRUCTED TO PREVENT EXCESSIVE EROSION UNTIL SHOULDERS ARE CONSTRUCTED AND THE SLOPES ARE SEEDED AND MULCHED.

TEMPORARY PIPE SLOPE DRAIN

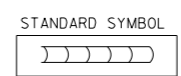

APPROVED *Jeff Harley* DATE 6-14-2006  
CHIEF ENGINEER

**Illinois Tollway**  
*Open Roads for a Faster Future*

TEMPORARY EROSION  
AND SEDIMENT CONTROL

DATE 05-12-2005 STANDARD NO. ESC 05-01



	SWALE TYPE A	SWALE TYPE B
C	1'	1'
D	4'	6'

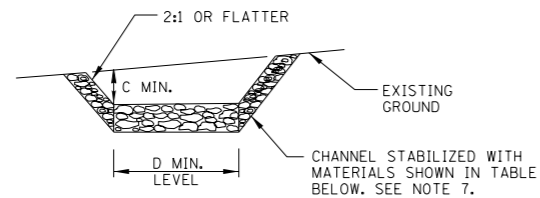

CROSS-SECTION

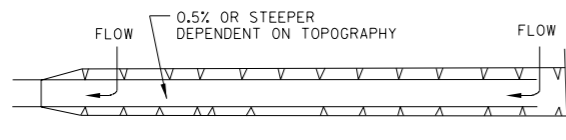

PLAN VIEW

NOTES:

- ALL TEMPORARY SWALES SHALL HAVE UNINTERRUPTED POSITIVE GRADE TO AN OUTLET.
- DIVERTED RUNOFF FROM A DISTURBED AREA SHALL BE CONVEYED TO A SEDIMENT TRAPPING DEVICE.
- DIVERTED RUNOFF FROM AN UNDISTURBED AREA SHALL OUTLET DIRECTLY INTO AN UNDISTURBED STABILIZED AREA AT NON-EROSIVE VELOCITY.
- ALL TREES, BRUSH, STUMPS, OBSTRUCTIONS, AND OTHER OBJECTIONABLE MATERIAL SHALL BE REMOVED AND DISPOSED OF SO AS NOT TO INTERFERE WITH THE PROPER FUNCTIONING OF THE SWALE.
- THE SWALE SHALL BE EXCAVATED OR SHAPED TO LINE, GRADE, AND CROSS SECTION AS REQUIRED TO MEET THE CRITERIA SPECIFIED HEREIN AND BE FREE OF BANK PROJECTIONS OR OTHER IRREGULARITIES WHICH WILL IMPEDE NORMAL FLOW.
- ALL EARTH REMOVED AND NOT NEEDED FOR CONSTRUCTION SHALL BE PLACED SO THAT IT WILL NOT INTERFERE WITH THE FUNCTIONING OF THE SWALE.
- STABILIZATION SHALL BE AS PER THE CHART BELOW:
  - TREATMENT TYPE I - TEMPORARY GROUND COVER AND EROSION BLANKET TYPE III.
  - TREATMENT TYPE II - CA3 STONE OR RECYCLED CONCRETE EQUIVALENT, IN LAYER AT LEAST 3 INCHES IN THICKNESS OVER GEOTEXTILE (FILTER FABRIC FOR USE WITH RIPRAP), PRESSED INTO THE SOIL WITH CONSTRUCTION EQUIPMENT.
  - TREATMENT TYPE III - GRADATION 3 RIPRAP IN A LAYER AT LEAST 8 INCHES THICK OVER GEOTEXTILE (FILTER FABRIC FOR USE WITH RIPRAP), PRESSED INTO THE SOIL.
  - APPROVED EQUIVALENTS CAN BE SUBSTITUTED FOR ANY OF THE ABOVE MATERIALS.

APPLICATION: SEE NOTES 2 & 3 ABOVE. DESIGN TEMPORARY SWALE FOR A 25-YEAR FREQUENCY, 24-HOUR DURATION STORM.

TEMPORARY SWALE

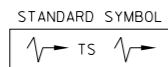

TEMPORARY SWALE AND DIVERSION DIKE STABILIZATION TREATMENT

TYPE OF TREATMENT	CHANNEL GRADE	SWALE OR DIKE TYPE A (5 AC OR LESS)	SWALE OR DIKE TYPE B (5 AC - 10 AC)
I	0.5-5.0%	SEED AND EROSION BLANKET TYPE III	SEED AND EROSION BLANKET TYPE III
II AND III	5.1-8.0%	CA-3 STONE OVER GEOTEXTILE (FILTER FABRIC FOR USE WITH RIPRAP)	GRADATION 3 RIPRAP, 8" THICKNESS OVER GEOTEXTILE (FILTER FABRIC FOR USE WITH RIPRAP)
III AND SPECIAL	8.1-20%	GRADATION 3 RIPRAP, 8" THICKNESS OVER GEOTEXTILE (FILTER FABRIC FOR USE WITH RIPRAP)	DESIGN BY DSE

NOTE: WHEN THE DRAINAGE AREA BEING CARRIED BY THE MEASURE IS LARGER THAN 10 ACRES, THE MEASURE WILL BE SIZED AND STABILIZED BASED ON A DESIGN BY THE DESIGN SECTION ENGINEER (DSE). DSE TO VERIFY TREATMENT TYPE AND CROSS SECTION IS ADEQUATE FOR THE DESIGN FLOW FOR 1 TO 10 ACRE DIVERSIONS.

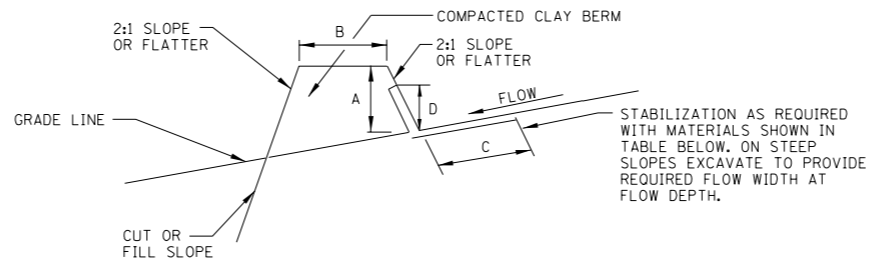

CROSS SECTION

	DIKE TYPE A (5AC OR LESS)	DIKE TYPE B (5-10AC)
A-DIKE HEIGHT	18"	36"
B-DIKE WIDTH	24"	36"
C-FLOW WIDTH	4'	6'
D-FLOW HEIGHT	8"	15"

NOTES:

- ALL DIKES SHALL BE COMPACTED.
- ALL DIKES SHALL HAVE POSITIVE DRAINAGE TO AN OUTLET.
- TOP WIDTH MAY BE WIDER AND SIDE SLOPES MAY BE FLATTER IF DESIRED TO FACILITATE CROSSING BY CONSTRUCTION TRAFFIC.
- FIELD LOCATION SHOULD BE ADJUSTED AS NEEDED TO UTILIZE A STABILIZED SAFE OUTLET.
- EARTH DIKES SHALL HAVE AN OUTLET THAT FUNCTIONS WITH A MINIMUM OF EROSION. RUNOFF SHALL BE CONVEYED TO A SEDIMENT TRAPPING DEVICE SUCH AS A SEDIMENT TRAP OR SEDIMENT BASIN WHERE EITHER THE DIKE CHANNEL OR THE DRAINAGE AREA ABOVE THE DIKE ARE NOT ADEQUATELY STABILIZED.
- DIVERTED RUNOFF FROM AN UNDISTURBED AREA SHALL OUTLET INTO AN UNDISTURBED STABILIZED AREA AT NON-EROSIVE VELOCITY.
- STABILIZATION OF AREAS C AND D SHALL BE AS PER THE CHART BELOW.

APPLICATION: SEE NOTE 6 ABOVE. DESIGN DIVERSION DIKE FOR A 100-YEAR FREQUENCY, 24-HOUR DURATION STORM.

DIVERSION DIKE

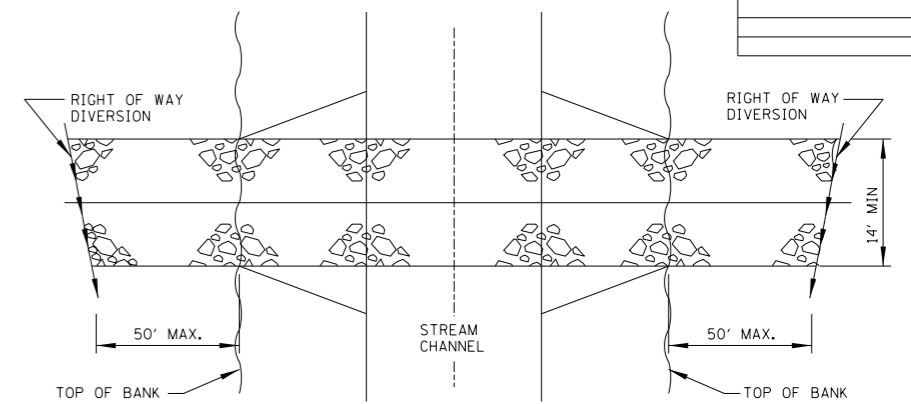
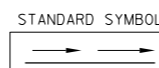

PLAN VIEW

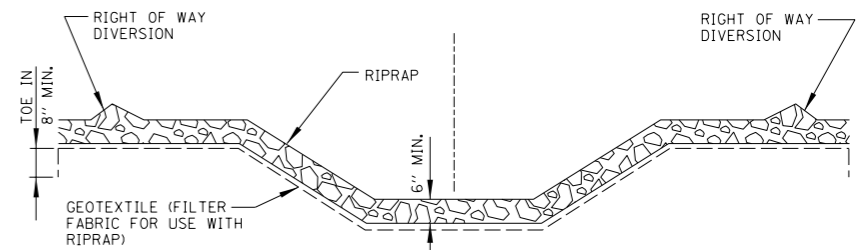

SECTION

NOTES:

- GEOTEXTILE (FILTER FABRIC FOR USE WITH RIPRAP) SHALL BE PLACED OVER THE CLEARED AREA PRIOR TO THE PLACING OF ROCK.
- ROCK OR RECLAIMED CONCRETE SHALL MEET RIPRAP, GRADATION 3 SPECIFICATIONS.
- THE STREAM CROSSING SHALL BE MADE AS PERPENDICULAR TO THE CENTERLINE OF THE STREAM AS POSSIBLE.
- THE CROSSING SHALL BE REMOVED IMMEDIATELY WHEN NO LONGER NEEDED AND THE STREAM CHANNEL RESTORED TO ITS ORIGINAL CROSS SECTION.
- WHEN THE STREAM HAS BASE FLOW, IT IS RECOMMENDED THAT A TEMPORARY PIPE BE INSTALLED IN THE BOTTOM OF THE CROSSING AND ADDITIONAL RIPRAP BE PLACED OVER THE PIPE TO PROTECT THE PIPE FROM CONSTRUCTION TRAFFIC. REFER TO PLANS FOR DETAILS.
- MAINTENANCE TO BE PERFORMED AS NEEDED AND MAY REQUIRE PERIODIC TOP DRESSING WITH ADDITIONAL RIPRAP.

APPLICATION: WHEN CULVERTS ARE NOT USED, THIS PRACTICE IS FOR LESS THAN ONE YEAR AND FOR DRAINAGE AREA LESS THAN ONE SQUARE MILE. AS A MINIMUM, DESIGN THE STRUCTURE TO PASS BANK FULL FLOW OR PEAK FLOW WHICHEVER IS MORE FROM A 2-YEAR FREQUENCY, 24-HOUR DURATION STORM WITHOUT OVERTOPPING. ENSURE THAT NO EROSION WILL RESULT FROM THE 10-YEAR PEAK STORM.

TEMPORARY STREAM CROSSING PLAN

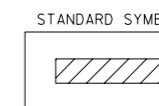

APPROVED: *Jeff Daley*  
 CHIEF ENGINEER DATE 6-14-2006

**Illinois Tollway**  
 Open Roads for a Faster Future

TEMPORARY EROSION AND SEDIMENT CONTROLS  
 DATE 05-12-2005 STANDARD NO. ESC 05-01

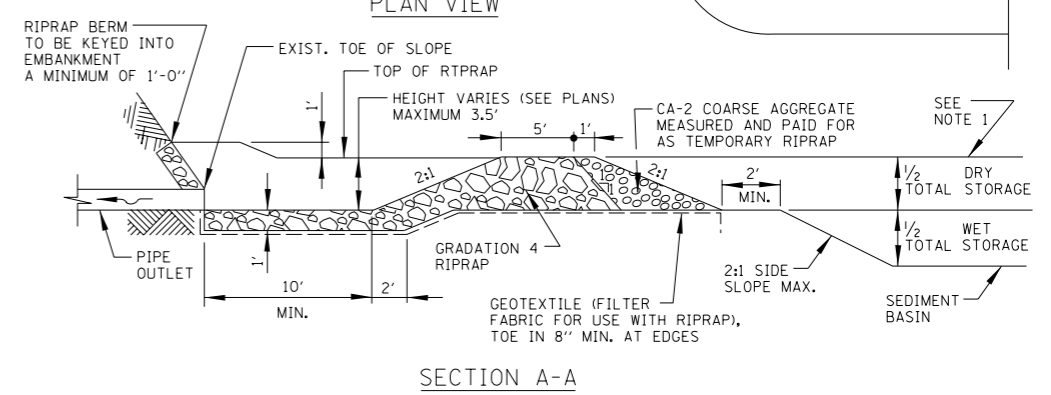
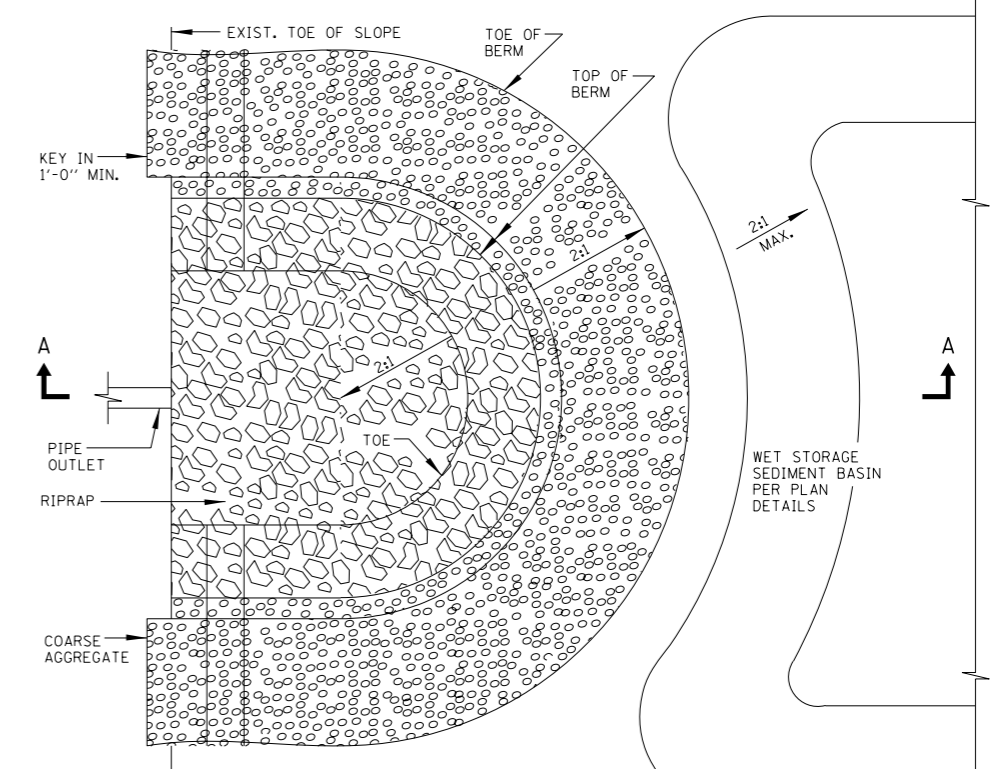
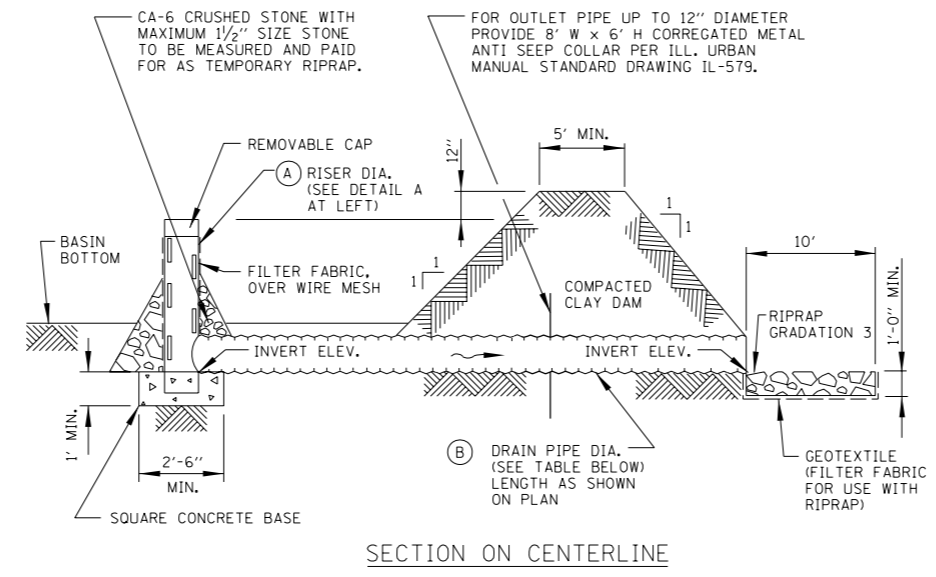
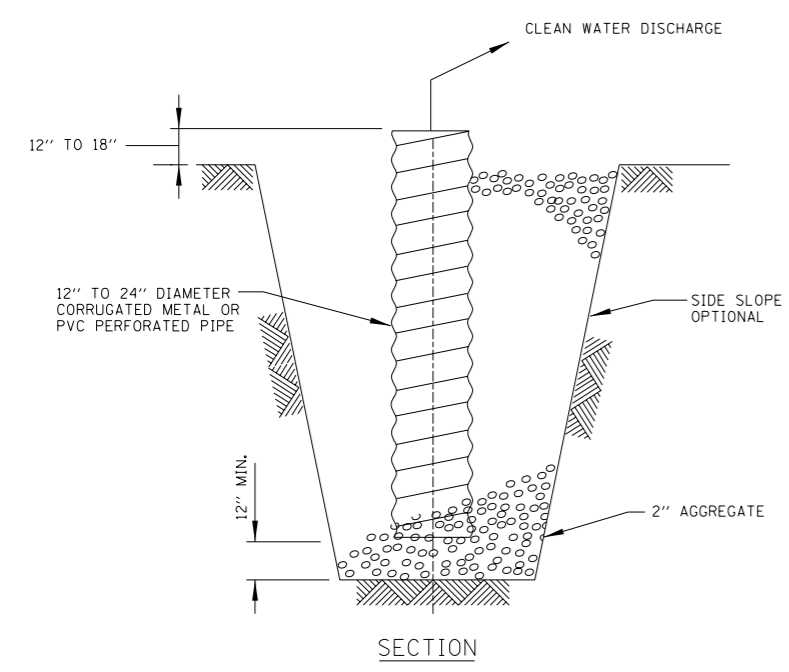

NOTES:

- PIT DIMENSIONS ARE OPTIONAL. PIT SHOULD BE SIZED FOR ANTICIPATED INFLOW.
- THE STANDPIPE WILL BE CONSTRUCTED BY PERFORATING A 12"-24" DIAMETER CORRUGATED METAL OR PVC PIPE.
- A BASE OF 2" AGGREGATE WILL BE PLACED IN THE PIT TO A MINIMUM DEPTH OF 12". AFTER INSTALLING THE STANDPIPE, THE PIT SURROUNDING THE STANDPIPE WILL THEN BE BACKFILLED WITH 2" AGGREGATE.
- THE STANDPIPE WILL EXTEND 12" TO 18" ABOVE THE LIP OF THE PIT.
- IF DISCHARGE WILL BE PUMPED DIRECTLY TO A STORM DRAINAGE SYSTEM, THE STANDPIPE WILL BE WRAPPED WITH FILTER FABRIC CONFORMING TO THE STANDARD SPECIFICATIONS.
- IF DESIRED 1/4" - 1/2" HARDWARE CLOTH MAY BE PLACED AROUND THE STANDPIPE PRIOR TO ATTACHING THE FILTER FABRIC. THIS WILL INCREASE THE RATE OF WATER SEEPAGE INTO THE PIPE.

APPLICATION: A TEMPORARY PIT TO TRAP AND FILTER WATER FOR PUMPING FROM EXCAVATED AREAS TO A STABILIZED AREA.

NOTES:

- DRAIN PIPE AND SLOTTED RISER SHALL BE FABRICATED FROM CORRUGATED METAL, SMOOTH STEEL OR PVC.
- SLOTS SHALL BE CUT CLEANLY AND DEBURRED. ENDS OF SLOTS MAY BE ROUND OR SQUARE.
- FABRICATED OR STANDARD ELBOW; FABRICATED OR STANDARD TEE WITH THE PIPE OR PLUG IN UPSTREAM END; OR STANDARD TEE WITH ONE END EMBEDDED IN CONCRETE.
- ONE INCH DIAMETER HOLES MAY BE SUBSTITUTED FOR 1"x4" SLOTS IN RISER PIPE. PROVIDE 32 - 1" HOLES PER FOOT OF RISER FOR 6" RISER PIPE. PROVIDE 48 - 1" HOLES PER FOOT OF RISER FOR 8" RISER PIPE. PROVIDE 64 - 1" HOLES PER FOOT OF RISER FOR 10" RISER PIPE.
- FILTER FABRIC OVER WIRE MESH SHALL CONFORM TO THE STANDARD SPECIFICATIONS
- WHEN SEDIMENT BASIN DEWATERING DEVICE IS USED FOR OUTLET CONTROL, BASIN SHALL BE DESIGNED FOR A 25-YR FREQUENCY, 24-HOUR DURATION STORM OR 3600 CUBIC FEET OF STORAGE PER ACRE OF DRAINAGE AREA, WHICHEVER IS GREATER. DRAINAGE AREA INCLUDES BOTH ON-SITE AND OFF-SITE TRIBUTARY AREAS.
- DSE MAY SPECIFY A "FAIRCLOTH" TYPE SKIMMER INSTEAD OF THE PERFORATED RISER TO DEWATER THE BASIN. PROVIDE SPECIAL PROVISION AND DETAIL.
- SEDIMENT TO BE REMOVED WHEN BASIN IS 50% FULL.
- SEE PLANS FOR DETAILS.

APPLICATION: FOR USE WHEN EXISTING OR PROPOSED DETENTION BASINS OR IN FIELD AREAS ARE USED FOR TEMPORARY SEDIMENT BASINS.

SUMP PIT PLAN

SEDIMENT BASIN DEWATERING DEVICE

STANDARD DIMENSIONS TABLE

A	B	C	D	MIN. WALL THICKNESS	
				CORR. GAGE	SMOOTH (INCHES)
RISER DIA. (INCHES)	DRAIN PIPE DIA. MIN. (INCHES)	1"x4" SLOTS (ROWS)	PLACE SLOTS AT (DEG.)	16	.10
6	4	4	90	16	.10
8	6	6	60	16	.10
10	8	8	45	16	.13

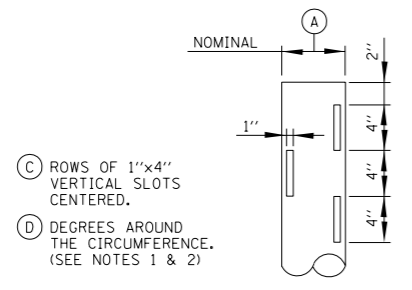

- C ROWS OF 1"x4" VERTICAL SLOTS CENTERED.
- D DEGREES AROUND THE CIRCUMFERENCE. (SEE NOTES 1 & 2)

DETAIL A - SLOTTED INLET

NOTES:

- WHEN SEDIMENT BASIN AGGREGATE BERM IS USED FOR OUTLET CONTROL, THE DETENTION STORAGE SHALL BE COMPOSED OF EQUAL VOLUMES OF "WET" AND "DRY" STORAGE. THE WET AND DRY STORAGE AREAS SHALL EACH (BOTH) BE SIZED FOR THE RUNOFF FROM EITHER A 2-YEAR FREQUENCY, 24-HOUR DURATION STORM FROM THE AREA DRAINING INTO THE BASIN UNDER MAXIMUM RUNOFF CONDITIONS DURING CONSTRUCTION, OR 3,600 CUBIC FEET/ACRE BASED ON THE AREA DRAINING INTO THE BASIN, WHICHEVER IS GREATER. HALF THE DETENTION STORAGE SHALL BE BELOW THE PERMEABLE FILL. DRAINAGE AREA INCLUDES BOTH ON-SITE AND OFF SITE TRIBUTARY AREAS.
- IF DESIRED, TO MINIMIZE EXCAVATION, THE BOTTOM OF THE WET STORAGE BASIN MAY BE DESIGNED AT THE PIPE OUTLET INVERT ELEVATION. PROVIDE COMPACTED CLAY DAM BELOW AGGREGATE BERM.
- AGGREGATE BERM AND ALL SEDIMENT SHALL BE REMOVED WHEN CONSTRUCTION IS COMPLETED. FILL ANY EXCAVATED AREA WITH COMPACTED CLAY EMBANKMENT MATERIAL, ZONE A.
- MAINTENANCE SHALL BE PERFORMED AS NEEDED. THE AGGREGATE BERM SHALL BE REPLACED IF WASHED OUT, DAMAGED BY CONSTRUCTION OR SILT ACCUMULATION. THE SILT SHALL BE CLEANED OUT WHEN THE WET STORAGE POOL PORTION OF BASIN IS 50% FULL. SEE PLANS FOR DETAILS.

APPLICATION: FOR USE WHEN EXISTING OR PROPOSED DETENTION BASINS OR INFIELD AREAS ARE USED FOR TEMPORARY SEDIMENT BASINS.

SEDIMENT BASIN AGGREGATE BERM

STANDARD SYMBOL



APPROVED *Jeff Haley* CHIEF ENGINEER DATE 6-14-2006

**Illinois Tollway**  
Open Roads for a Faster Future

TEMPORARY EROSION AND SEDIMENT CONTROLS

DATE 05-12-2005 STANDARD NO. ESC 05-01

REVISIONS

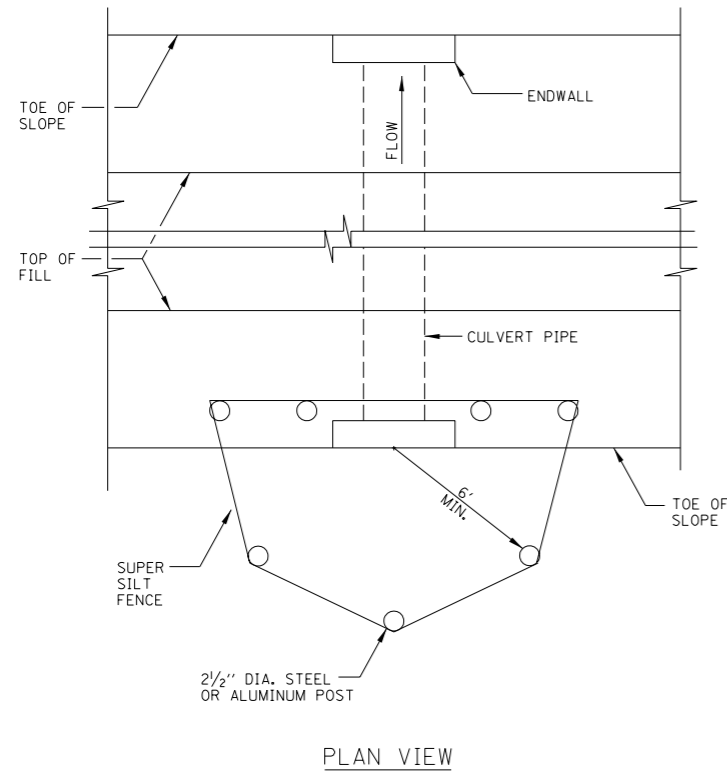

PLAN VIEW

NOTES:

1. CONSTRUCT SUPER SILT FENCE PER SHEET 5 (OF 11) IN THIS SERIES, EXCEPT THE MAXIMUM POST SPACING SHALL BE 6 FEET.
2. MAINTENANCE SHALL BE PERFORMED AS NEEDED. SEDIMENT SHALL BE REMOVED WHEN IT REACHES 50% OF THE FENCE HEIGHT.
3. THE CULVERT INLET PROTECTION AND SEDIMENT SHALL BE REMOVED WHEN CONSTRUCTION IS COMPLETE.
4. THE CULVERT INLET PROTECTION - FENCE TO BE MEASURED AND PAID FOR AS SUPER SILT FENCE.

APPLICATION: DEVICE TO BE USED AT CULVERT INLET. MAXIMUM DRAINAGE AREA TO THE CULVERT BEING PROTECTED IS 1 ACRE.

CULVERT INLET PROTECTION - FENCE

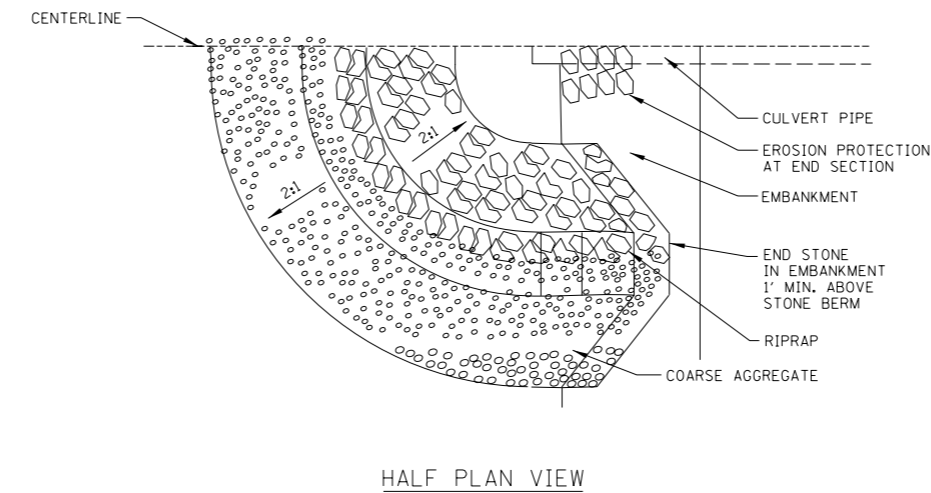
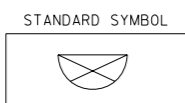

HALF PLAN VIEW

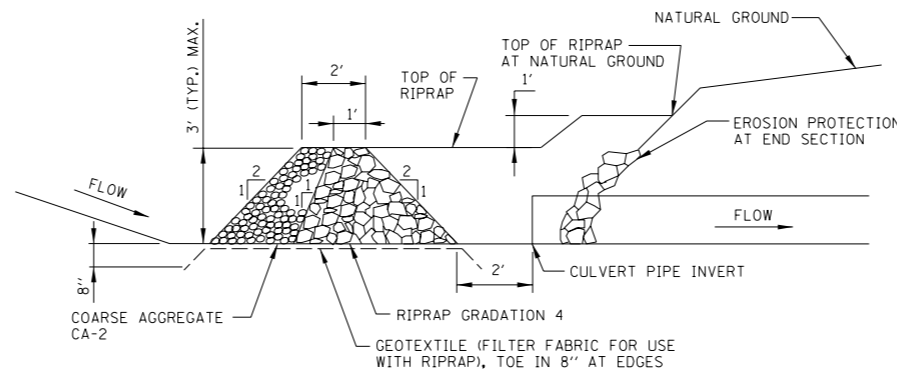

CENTERLINE CROSS SECTION

NOTES:

1. MAINTENANCE SHALL BE PERFORMED AS NEEDED. SEDIMENT SHALL BE REMOVED WHEN IT REACHES 50% OF THE STONE HEIGHT.
2. THE CULVERT INLET PROTECTION AND SEDIMENT SHALL BE REMOVED WHEN CONSTRUCTION IS COMPLETE.
3. THE CULVERT INLET PROTECTION - STONE TO BE MEASURED AND PAID FOR AS TEMPORARY RIPRAP.

APPLICATION: DEVICE TO BE USED AT CULVERT INLET, MAXIMUM DRAINAGE AREA TO THE CULVERT BEING PROTECTED IS 3 ACRES.

CULVERT INLET PROTECTION - STONE

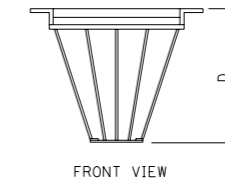
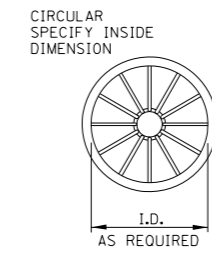
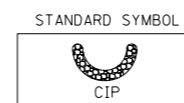

INLET BASKET  
(SEE NOTE 3 BELOW)

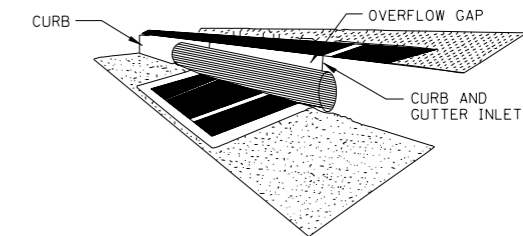
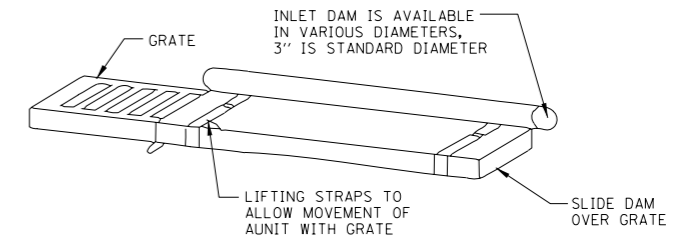

INLET DAM

NOTES:

1. FILTER FABRIC INLET PROTECTION SHALL CONSIST OF INLET BASKET AND FABRIC INSERT, FABRIC INSERT, OR INLET DAM PLACED IN FRONT OF CURB INLET.
2. DEVICE SHALL BE EQUIPPED WITH AN OVERFLOW FEATURE SO DRAINAGE TO INLET IS NOT COMPLETELY BLOCKED IF DEVICE IS FULL OF SILT. DESIGNER SHALL VERIFY THAT OVERFLOW FEATURE HAS CAPACITY TO HANDLE RUNOFF REACHING STRUCTURES WITHIN SAGS. IF OVERFLOW FEATURE DOES NOT HAVE THE CAPACITY, DESIGNERS SHALL PROVIDE ALTERNATE TYPE OF CONTROL DEVICE TO INSURE AREA SURROUNDING THE STRUCTURE DOES NOT FLOOD.
3. INLET BASKET IS AVAILABLE TO FIT ROUND, RECTANGULAR, BEEHIVE OR CURB INLET CASTINGS.
4. MAINTENANCE SHALL BE PERFORMED AS NEEDED. REMOVE SILT FROM FABRIC INSERT WHEN 50% OF CAPACITY IS REACHED. REMOVE SILT FROM INTERIOR AND EXTERIOR OF INLET DAM WHEN 50% OF DAM HEIGHT IS REACHED.

APPLICATION: TO BE USED ONLY WITHIN PAVED AREAS WHEN DISTURBED TURF AREAS DRAIN TO PAVED AREAS. USE IN CONJUNCTION WITH ADDITIONAL UPSTREAM PROTECTIVE MEASURES SUCH AS SILT FENCE. INLET DAM NOT TO BE USED AT PAVEMENT SAGS.

FILTER FABRIC INLET PROTECTION

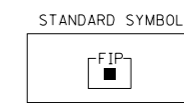

APPROVED *Jeff Haley* CHIEF ENGINEER DATE 6-14-2006



TEMPORARY EROSION AND SEDIMENT CONTROLS

DATE 05-12-2005 STANDARD NO. ESC 05-01