

SIGN TS-2 (O)

COLOR: BACKGROUND - FLUORESCENT ORANGE (O)
 BORDER AND SYMBOL - BLACK
 SIZE: 48"x48"
 LETTERING: 7" FEDERAL SERIES D
 MOUNTING HOLES: 7/16" DIA., 4 HOLES SPACED AS SHOWN

SIGN NO.	LEGEND	A	B
TS-2A	AHEAD	15.50"	15.50"
TS-2B	500 FT	14.25"	15.13"
TS-2C	1000 FT	14.88" L2	15.75" L2
TS-2D	1500 FT	14.88" L2	15.75" L2
TS-2E	1/2 MILE	15.75" L3	15.75" L3
TS-2F	1 MILE	13.06"	13.06"

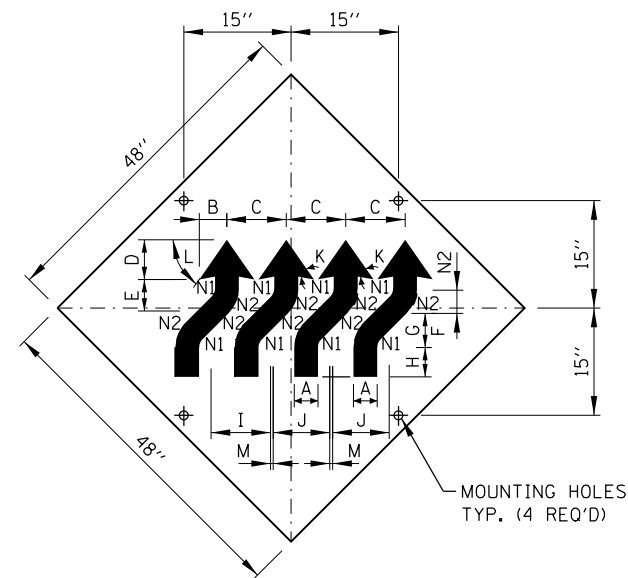

SIGN W1-4dR (O)

COLOR: BACKGROUND-FLUORESCENT ORANGE (O)
 TYPE A REFLECTIVE SHEETING PER STANDARD SPECIFICATIONS (*A)
 BORDER AND LETTERS-BLACK
 SIZE: 48"x48"
 MOUNTING HOLES: 7/16" DIA., 4 HOLES SPACED AS SHOWN.

A	4 1/2"
B	5 3/4"
C	12 1/2"
D	7 3/4"
E	6 1/2"
F	4 1/2"
G	6 1/2"
H	6"
I	12 3/4"
J	12"
K	45°
L	55°
M	3/4"
N1	2"
N2	6 1/2"

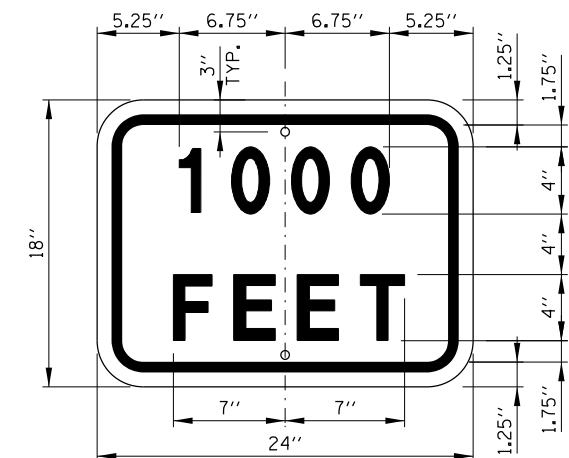

COLOR: BACKGROUND - FLUORESCENT ORANGE (O)
 BORDER AND LETTERS - BLACK
 SIZE: 24"x18"
 LETTERING: 4" FEDERAL SERIES D
 MOUNTING HOLES: 7/16" DIA., 2 HOLES SPACED AS SHOWN

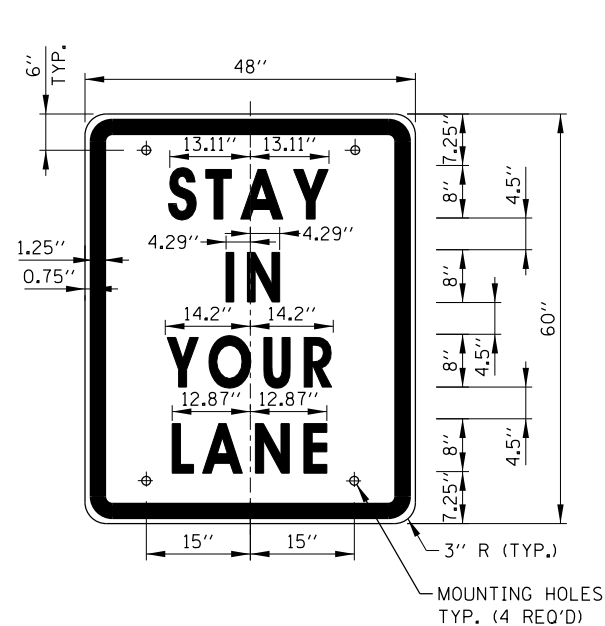

SIGN TS-3

COLOR: BACKGROUND - WHITE (REFLECTORIZED) (*A)
 BORDER AND LETTERS - BLACK
 SIZE: 48"x60"
 LETTERING: LEGEND - 8" FEDERAL SERIES D
 MOUNTING HOLES: 7/16" DIA., 4 HOLES, SPACED AS SHOWN

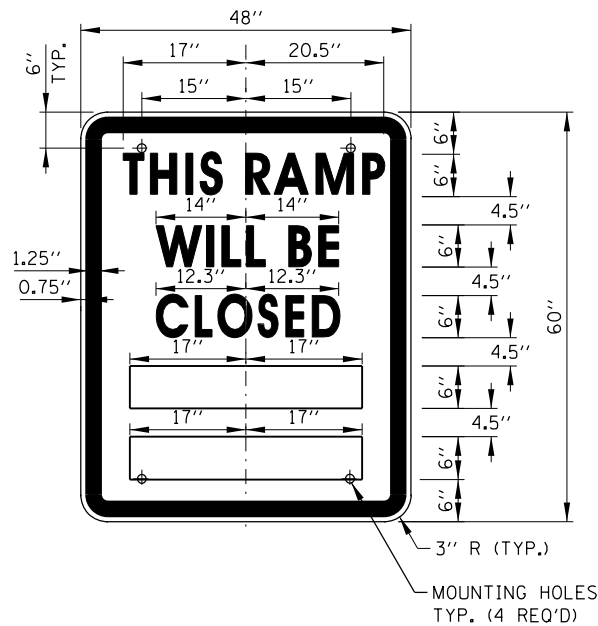

SIGN TS-4

COLOR: BACKGROUND - WHITE (REFLECTORIZED)(*A)
 BORDER AND LETTERS - BLACK
 SIZE: 48"x60"
 LETTERING: LEGEND - 6" FEDERAL SERIES C
 MOUNTING HOLES: 7/16" DIA., 4 HOLES, SPACED AS SHOWN

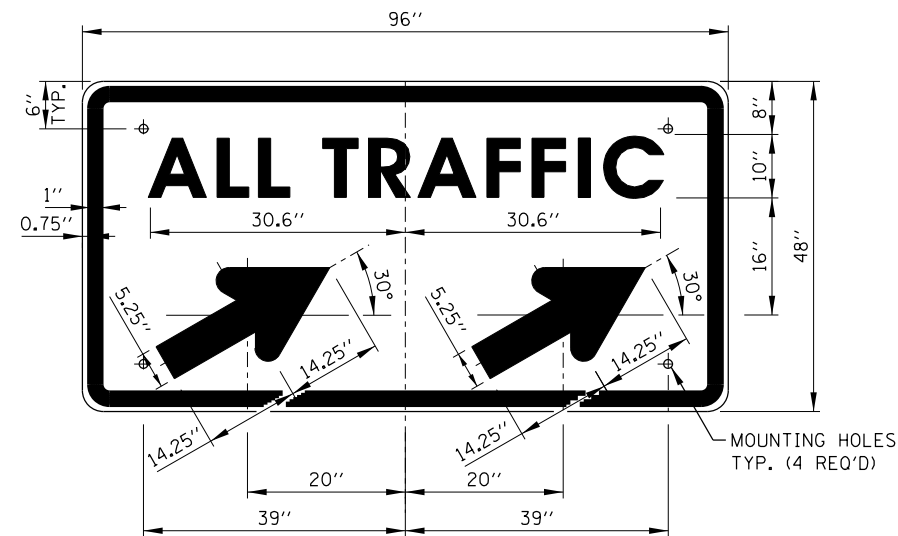

SIGN TS-5a & TS-5b

COLOR: BACKGROUND - WHITE (REFLECTORIZED)(*A)
 BORDER AND LETTERS - BLACK
 ARROW - BLACK
 SIZE: 96"x48"
 LETTERING: 10" FEDERAL SERIES D
 MOUNTING HOLES: 7/16" DIA., 4 HOLES, SPACED AS SHOWN
 NOTE: SIGN TS-5a IS SHOWN, SUBSTITUTE LEGEND "↗" FOR "↘" FOR SIGN TS-5b

NOTES:

- ALL LETTERING IS DESIGNATED BY SIZE AND SERIES IN ACCORDANCE WITH THE LATEST EDITION OF "STANDARD ALPHABETS FOR HIGHWAY SIGNS AND PAVEMENT MARKINGS" AS PUBLISHED BY THE U.S. DEPARTMENT OF TRANSPORTATION. LETTERING SPACING SHALL BE IN ACCORDANCE WITH THIS GUIDE EXCEPT WHERE NOTED.
- SYMBOLS AND ARROWS SHALL CONFORM TO THE DETAILS SHOWN IN THE LATEST EDITION OF "STANDARD HIGHWAY SIGNS" AS PUBLISHED BY THE U.S. DEPARTMENT OF TRANSPORTATION.
- SEE THE CONTRACT REQUIREMENTS FOR ADDITIONAL NOTES AND SPECIFICATIONS.
 (O) FLUORESCENT ORANGE REFLECTIVE SHEETING PER THE STANDARD SPECIFICATIONS.
 (*A) - REFLECTIVE SHEETING PER THE STANDARD SPECIFICATIONS.
- DIMENSIONS INDICATED THUS L ARE BASED ON A REDUCTION IN STANDARD LETTERING SPACING AS SHOWN BELOW:
 L1 SPACING REDUCED BY 25%
 L2 SPACING REDUCED BY 40%
 L3 SPACING REDUCED BY 50%

RAMP CLOSURE ADVANCE INFORMATION SIGN

THE VARIABLE MESSAGE WITH DATES FOR THE BOTTOM TWO LINES SHALL BE DETERMINED BY THE ENGINEER AND GIVEN TO THE CONTRACTOR BEFORE THE REQUIRED FIELD ERECTION DATE.

APPROVED: *Paul Kovacs* DATE 5-1-2009
 CHIEF ENGINEERING OFFICER

DATE	REVISIONS
3-01-2019	REMOVED STANDARD IDOT SIGNS, REVISED WZSL ASSEMBLY, ADDED WZSL TRANSITION
3-31-2017	REVISED END WZSL SIGN COLOR
3-11-2015	REVISED NOTES
03-31-14	REVISED FINE SIGN NUMBER AND ADDED LED SPEED LIMIT DISPLAY
11-01-12	DELETED SIGN TS-1

CONSTRUCTION SIGNS

STANDARD E1-07

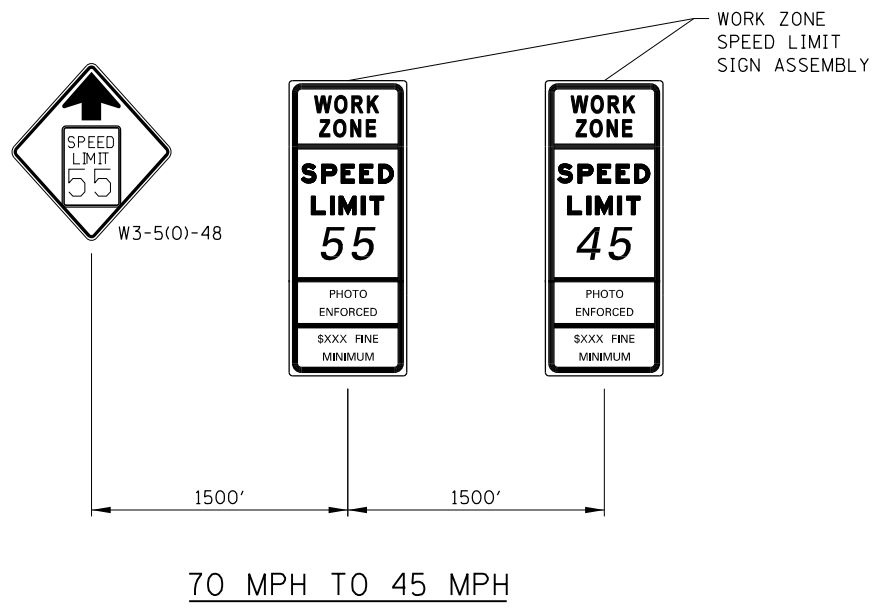

70 MPH TO 45 MPH

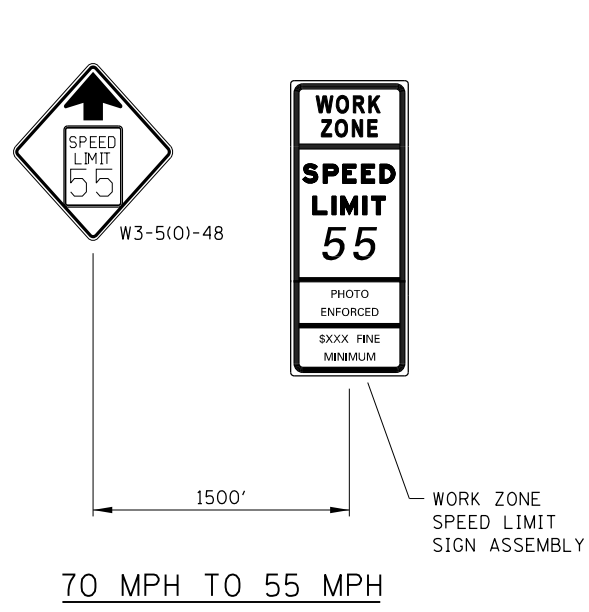

70 MPH TO 55 MPH

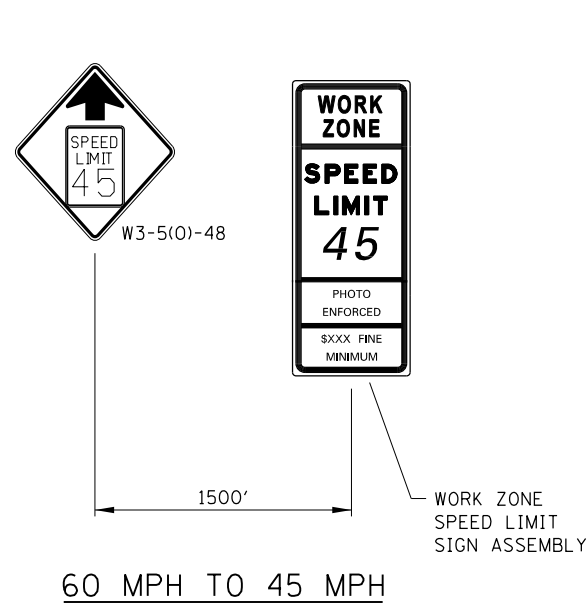

60 MPH TO 45 MPH

WORK ZONE SPEED LIMIT TRANSITION SIGNAGE

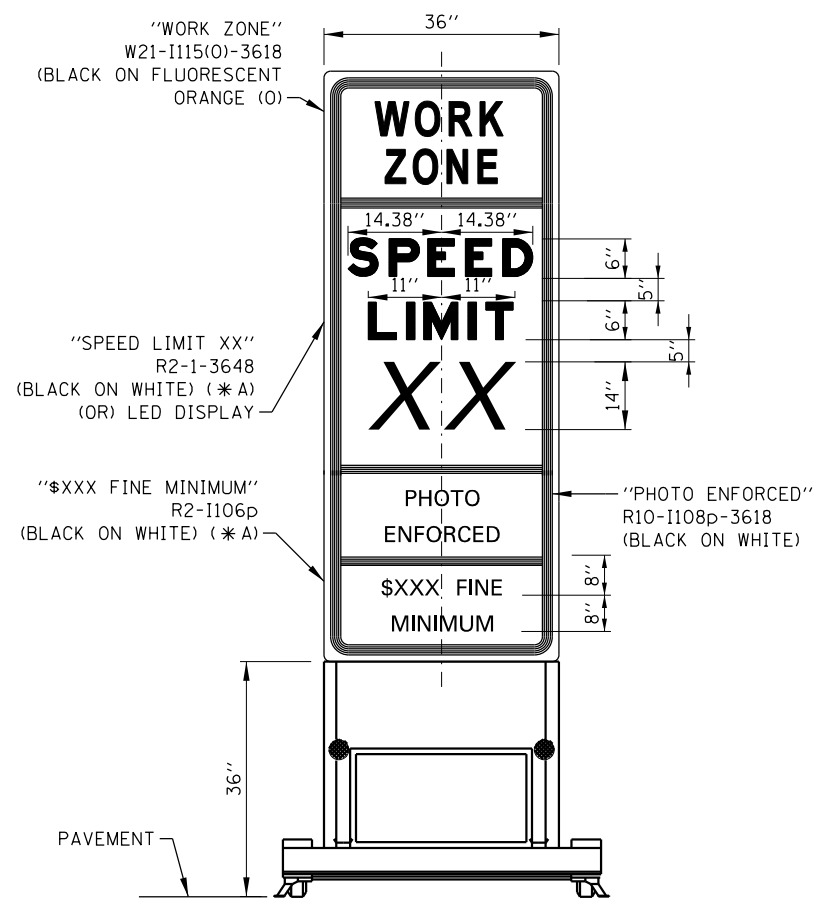

WORK ZONE SPEED LIMIT SIGN ASSEMBLY

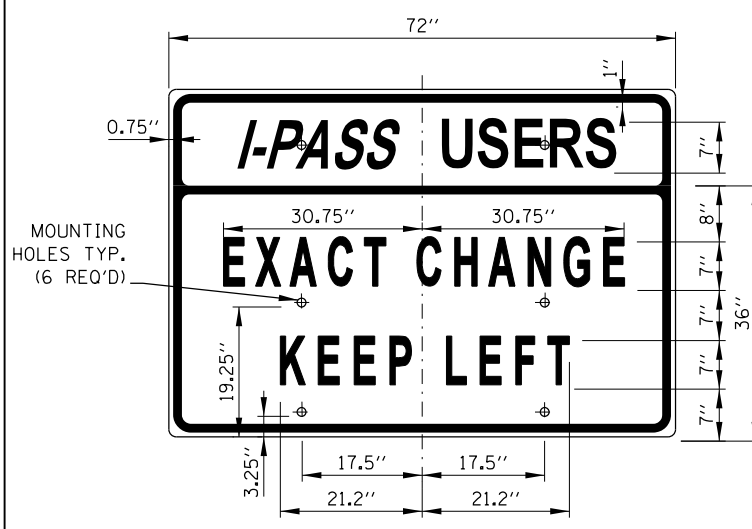

SIGN TS-7

COLOR: BACKGROUND - WHITE (REFLECTORIZED) (* A)
 BORDER AND LETTERS - BLACK
 SIZE: 72"x36"
 LETTERING: 7" FEDERAL SERIES C
 MOUNTING HOLES: 1/16" DIA., 4 HOLES SPACED AS SHOWN

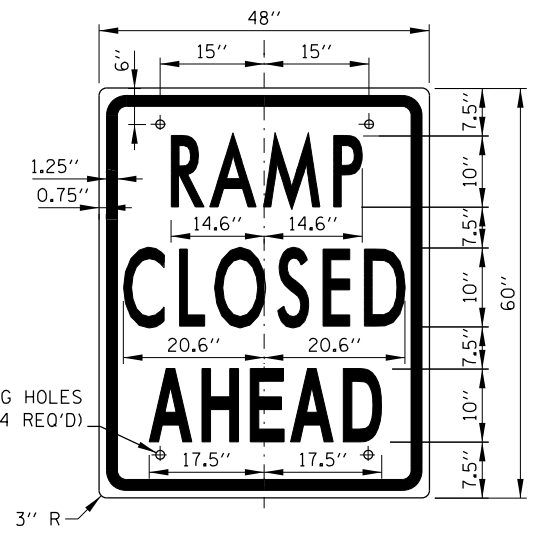

SIGN TS-9

COLOR: BACKGROUND - WHITE (REFLECTORIZED) (* A)
 BORDER AND LETTERS - BLACK
 SIZE: 48"x60"
 LETTERING: 10" FEDERAL SERIES C
 MOUNTING HOLES: 1/16" DIA., 4 HOLES SPACED AS SHOWN

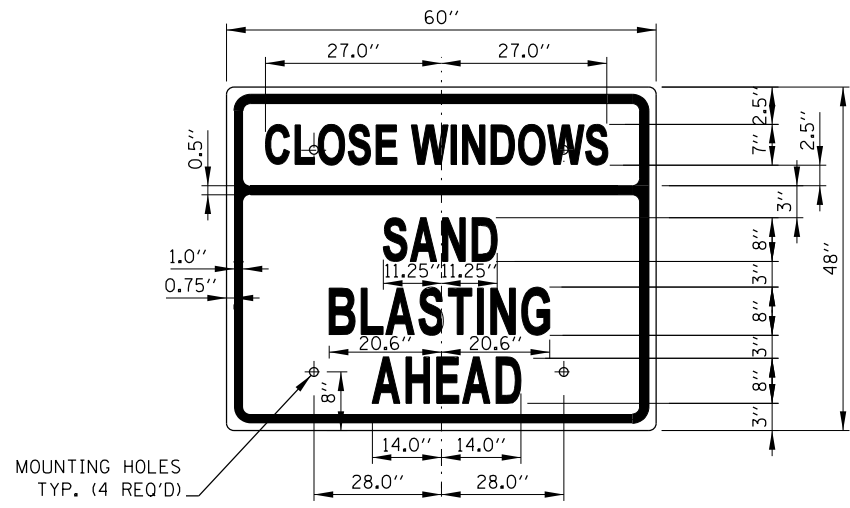

SIGN TS-10 (O)

COLOR: BACKGROUND - FLUORESCENT ORANGE (O)
 BORDER AND LETTERS - BLACK
 SIZE: 60"x48"
 LETTERING: 8" FEDERAL SERIES C, 7" FEDERAL SERIES B
 MOUNTING HOLES: 1/16" DIA., 4 HOLES SPACED AS SHOWN

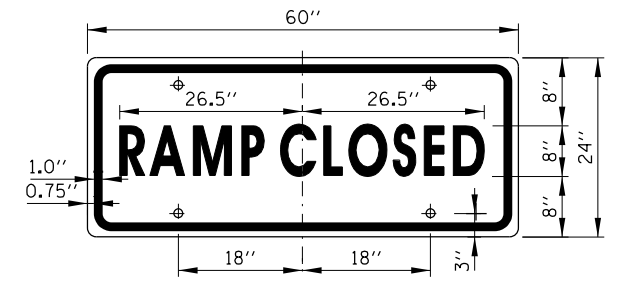

SIGN TS-6

COLOR: BACKGROUND - WHITE (REFLECTORIZED) (* A)
 BORDER AND LETTERS - BLACK
 SIZE: 60"x24"
 LETTERING: 8" FEDERAL SERIES C
 MOUNTING HOLES: 1/16" DIA., 4 HOLES SPACED AS SHOWN



CONSTRUCTION SIGNS

STANDARD E1-07

APPROVED: *Paul Kovacs* DATE 5-1-2009
 CHIEF ENGINEERING OFFICER

NOTE:
 SEE SHEET 1 OF THIS SERIES FOR NOTES.

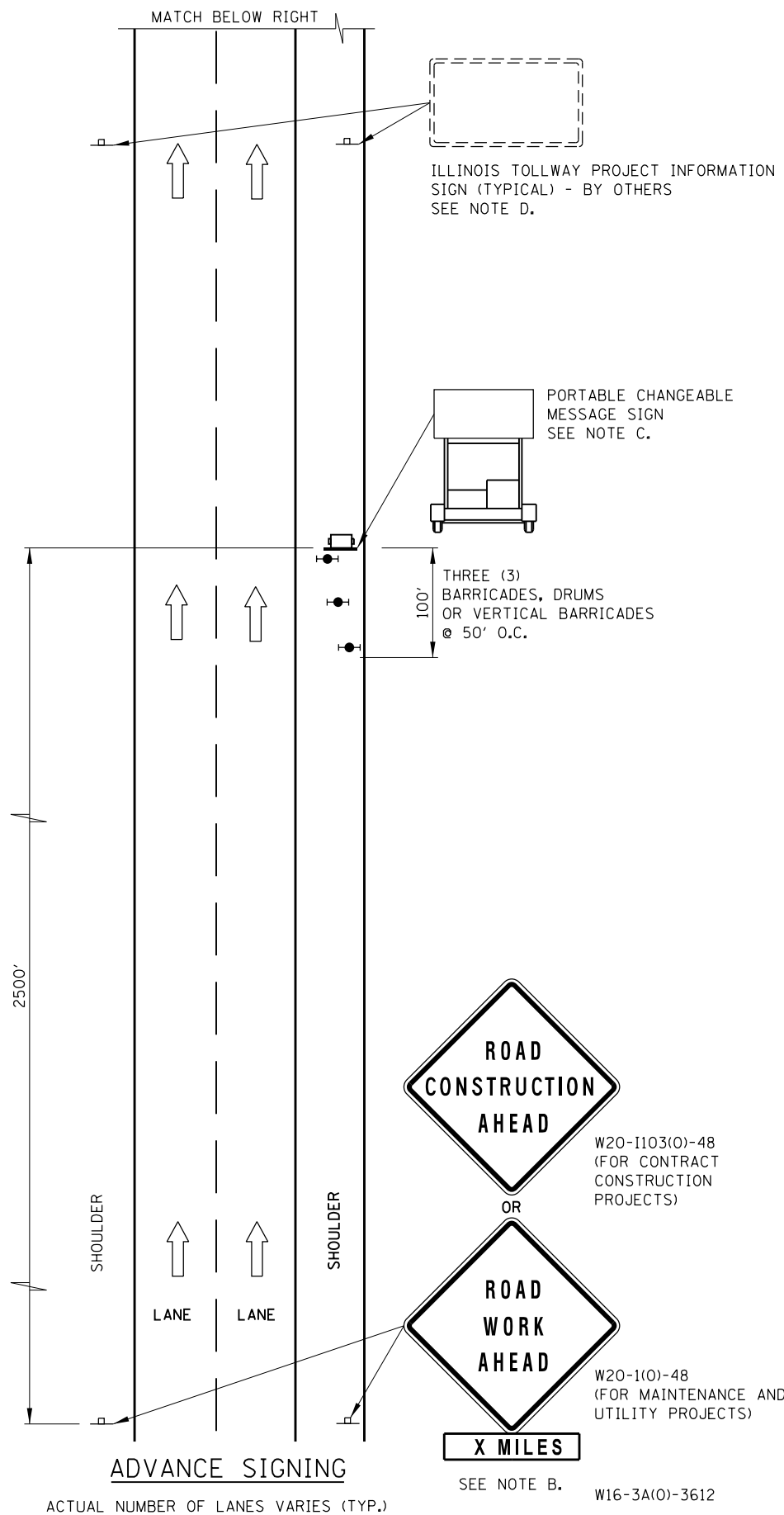

ADVANCE SIGNING NOTES:

- A. THE ADVANCE SIGNING SHOWN ON THIS STANDARD SHALL APPLY ANY TIME THE CONTRACTOR CLOSES ONE OR MORE LANES, OR IS REQUIRED TO SHIFT THE LANE ALIGNMENT. THE "ROAD WORK AHEAD" OR "ROAD CONSTRUCTION AHEAD" SIGNS, WORK ZONE PUBLIC INFORMATION SIGNS AND PORTABLE CHANGEABLE MESSAGE ARE STATIONARY.
- B. THE ROAD CONSTRUCTION AHEAD SIGN (W20-1A, WITH W16-3a SUPPLEMENTAL PLATE) OR ROAD WORK AHEAD SIGN (W20-1, WITH W16-3A SUPPLEMENTAL PLATE) SHALL BE LOCATED UP TO 5 MILES IN ADVANCE OF THE PROJECT LIMITS, WITH THE LOCATION BEING DETERMINED BY THE ENGINEER.
- C. THE PORTABLE CHANGEABLE MESSAGE SIGN SHALL BE USED TO DISPLAY THE STATUS OF LANE WITHIN THE CONTRACT LIMITS. THE PRIMARY MESSAGES SHALL BE: "RIGHT LANE(S) CLOSED" / "X MILES AHEAD", "LEFT LANE(S) CLOSED" / "X MILES AHEAD", "LANE(S) SHIFT" / "X MILES AHEAD", "ALL LANES OPEN". THE PORTABLE CHANGEABLE MESSAGE SIGN MAY BE MOVED TO THE MEDIAN SHOULDER WHEN THE LANE CLOSURES ARE ON THE LEFT, PROVIDED THE EXISTING SHOULDER WIDTH IS ADEQUATE.
- D. THE ILLINOIS TOLLWAY WILL FURNISH AND INSTALL STATIC PROJECT INFORMATION SIGNS IN ADVANCE, THROUGH AND AT THE END OF THE WORK ZONE. THESE SIGNS WILL BE INSTALLED ALONG THE OUTSIDE SHOULDER WITH THE ADVANCE SIGNS LOCATED BEYOND THE PORTABLE CHANGEABLE MESSAGE SIGN. THE ENGINEER AND CONTRACTOR SHALL COORDINATE WITH THE ILLINOIS TOLLWAY REGARDING THE LOCATION OF THESE SIGNS AND NOTIFY THE ILLINOIS TOLLWAY OF ANY DAMAGE TO THE SIGNS OR SUPPORTS.

LEGEND

- ARROW BOARD
- WORK AREA
- SIGN
- DIRECTION INDICATOR BARRICADE WITH SEQUENTIAL FLASHING WARNING LIGHT
- TYPE II BARRICADE, DRUM, OR VERTICAL BARRICADE WITH LIGHT IF REQUIRED. SEE ARTICLE 701.05(a)(5)
- FLAGGER WITH TRAFFIC CONTROL SIGN
- WORKER
- LANE CLOSED
- CHECK BARRICADE
- TRUCK MOUNTED ATTENUATOR



DATE	REVISIONS
3-01-2021	DELETED WORK ZONE PUBLIC INFORMATION SIGN.
3-01-2020	CLARIFIED TMA REQUIREMENTS, UPDATED BARRICADE LIGHT CALL-OUTS
3-01-2019	REARRANGED DETAILS, REVISED NOTE 17, ADDED NOTES 18 & 19, ADDED TMA
3-31-2017	ADDED TAPER RATE TABLE

APPROVED: *Paul Kovacs* DATE 5-1-2009
CHIEF ENGINEERING OFFICER

LANE CLOSURE NOTES:

- IF CLOSURES ARE EXPECTED TO PRODUCE TRAFFIC BACKUPS EXTENDING BEYOND THE FIRST WARNING SIGN SHOWN ON THE DETAILS, ADDITIONAL UPSTREAM SIGNS SHALL BE PLACED SO THAT THE TRAFFIC CONTROL ZONE ENCOMPASSES THE ANTICIPATED BACKUP ZONE.
- LONGITUDINAL DIMENSIONS MAY BE ADJUSTED SLIGHTLY TO FIT FIELD CONDITIONS.
- THESE DETAILS ALSO APPLY TO OPPOSITE HAND LANE CLOSURES BY CHANGING SIGN LEGENDS AND ARROW DIRECTIONS TO INDICATE THE APPROPRIATE CLOSURE.
- FOR NIGHT TIME CLOSURES, ONE TYPE A WARNING LIGHT SHALL BE INSTALLED ABOVE EACH OF THE 1 MILE AND 1/2 MILE ADVANCE WARNING SIGNS. FOR DAYLIGHT - ONLY CLOSURES, THE LIGHTS MAY BE OMITTED.
- FOR ANY LANE CLOSURE, FLASHING ARROW BOARDS SHALL BE REQUIRED AND IN OPERATION AT ALL TIMES. THE FLASHING ARROW BOARD IN ADVANCE OF THE TAPER SHALL BE PROTECTED WITH THREE TYPE II BARRICADES AT 50' O.C.
- CONSTRUCTION SIGNS SHALL GENERALLY BE POST - MOUNTED OR ATTACHED TO PORTABLE SUPPORTS AND SHALL BE INSTALLED 8' TO 12' FROM ADJACENT TRAVEL LANE WHEREVER POSSIBLE. IN NO CASE SHALL SIGNS BE LOCATED TO PROVIDE LESS THAN 2' CLEARANCE BETWEEN EDGE OF SIGN AND ADJACENT TRAVEL LANE.
- PAVEMENT MARKING TAPE AND REMOVAL OR OBLITERATION OF EXISTING MARKINGS SHALL BE REQUIRED WHEN THE CLOSURE TIME EXCEEDS FOUR DAYS. THIS WORK SHALL BE MEASURED AND PAID FOR SEPARATELY.
- WHEN A FLAGGER IS NOT ON STATION, THE FLAGGER SIGN SHALL BE PROMPTLY REMOVED, COVERED OR TURNED TO FACE AWAY FROM TRAFFIC. FLAGGER SIGNS SHALL BE MOVED AS NECESSARY TO MAINTAIN THE REQUIRED SPACING BETWEEN THE SIGNS AND THE WORKERS IN EACH SEPARATE WORK ACTIVITY, PER THE ILLINOIS TOLLWAY SUPPLEMENTAL SPECIFICATIONS.
- WORK ZONE SPEED LIMIT SIGN ASSEMBLIES, SHALL BE PLACED ADJACENT TO THE OPEN TRAFFIC LANE(S). WORK ZONE SPEED SIGNS SHALL BE MOVED AS NECESSARY TO MAINTAIN THE REQUIRED SPACING BETWEEN SIGNS AND THE WORKERS IN EACH SEPARATE WORK ACTIVITY PER THE ILLINOIS TOLLWAY SUPPLEMENTAL SPECIFICATIONS.
- DIRECTION INDICATOR BARRICADES SHALL BE USED IN LANE TAPERS.
- FOR CLOSURES OTHER THAN SHORT TERM (SUNRISE TO ONE HOUR BEFORE SUNSET), THE MINIMUM HEIGHT OF THE SIGN FROM SHOULDER ELEVATION SHALL BE 7'-0".
- CONES MAY BE USED IN LIEU OF BARRICADES IN THE BUFFER AND WORK AREAS, WHEN THE CLOSURE IS FOR MAINTENANCE OPERATIONS.
- BARRICADES ARE TO BE LOCATED AT JOINT LINE WHEN WORK AREA EXTENDS UP TO JOINT UNLESS OTHERWISE SHOWN ON THE PLANS.
- SEE MAINTENANCE OF TRAFFIC DRAWINGS FOR ADDITIONAL SIGNING IN THIS AREA.
- CHECK BARRICADES SHALL BE PLACED IN EACH CLOSED LANE AND SHOULDER AT 1000 FOOT CENTERS.
- A 1'-0" MINIMUM/2'-0" DESIRABLE SHY DISTANCE SHALL BE PROVIDED, MEASURED BETWEEN EDGE OF PAVEMENT LANE MARKING TO THE EDGE OF THE TRAFFIC CONTROL DEVICE.
- SEE STANDARD E1 FOR ADDITIONAL SIGNAGE REQUIRED WHEN WORK ZONE SPEED LIMIT IS REDUCED BY MORE THAN 10 MPH. THE SPEED LIMIT SHALL BE TRANSITIONED TO THE SPECIFIED WORK ZONE SPEED LIMIT 2600 FEET BEFORE THE FIRST W4-2 SIGN.
- WHEN NO POSITIVE PROTECTION IS PROVIDED AND WORKERS OR EQUIPMENT ENCR OACH WITHIN 2'-0" OR LESS FROM THE EDGE OF TRAVELED WAY, THE LANE OPEN TO TRAFFIC SHALL BE TEMPORARILY CLOSED OR SHIFTED DURING WORK ACTIVITIES.
- IN WORK ZONES WITH NO POSITIVE PROTECTION, A TRUCK MOUNTED ATTENUATOR (TMA) SHALL BE PROVIDED WITH A BUFFER AREA BETWEEN THE FRONT OF THE TMA AND WORKERS OR EQUIPMENT. THE BUFFER AREA SHALL BE 200' UNLESS OTHERWISE DETERMINED. WHERE WORKERS OR EQUIPMENT ARE PRESENT BEYOND THE WORK AREA, AN ADDITIONAL TMA SHALL BE PROVIDED TO EACH WORK AREA. A WORK AREA IS DEFINED AS STARTING AT THE END OF THE BUFFER AREA, EXTENDING 1000 FEET BEYOND THIS POINT.

SHEET 2 OF 3

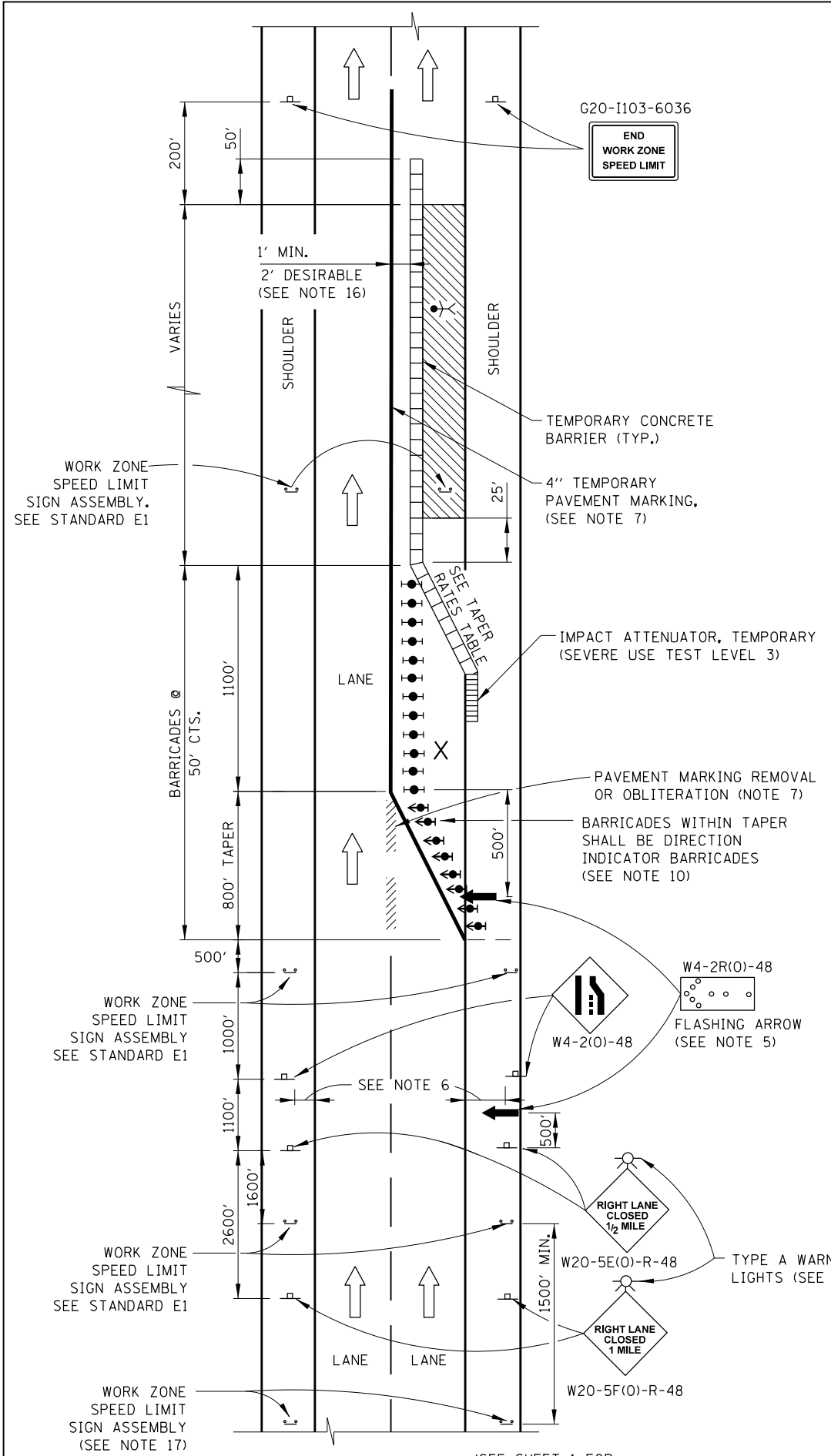

ONE - LANE CLOSURE WITH BARRIER

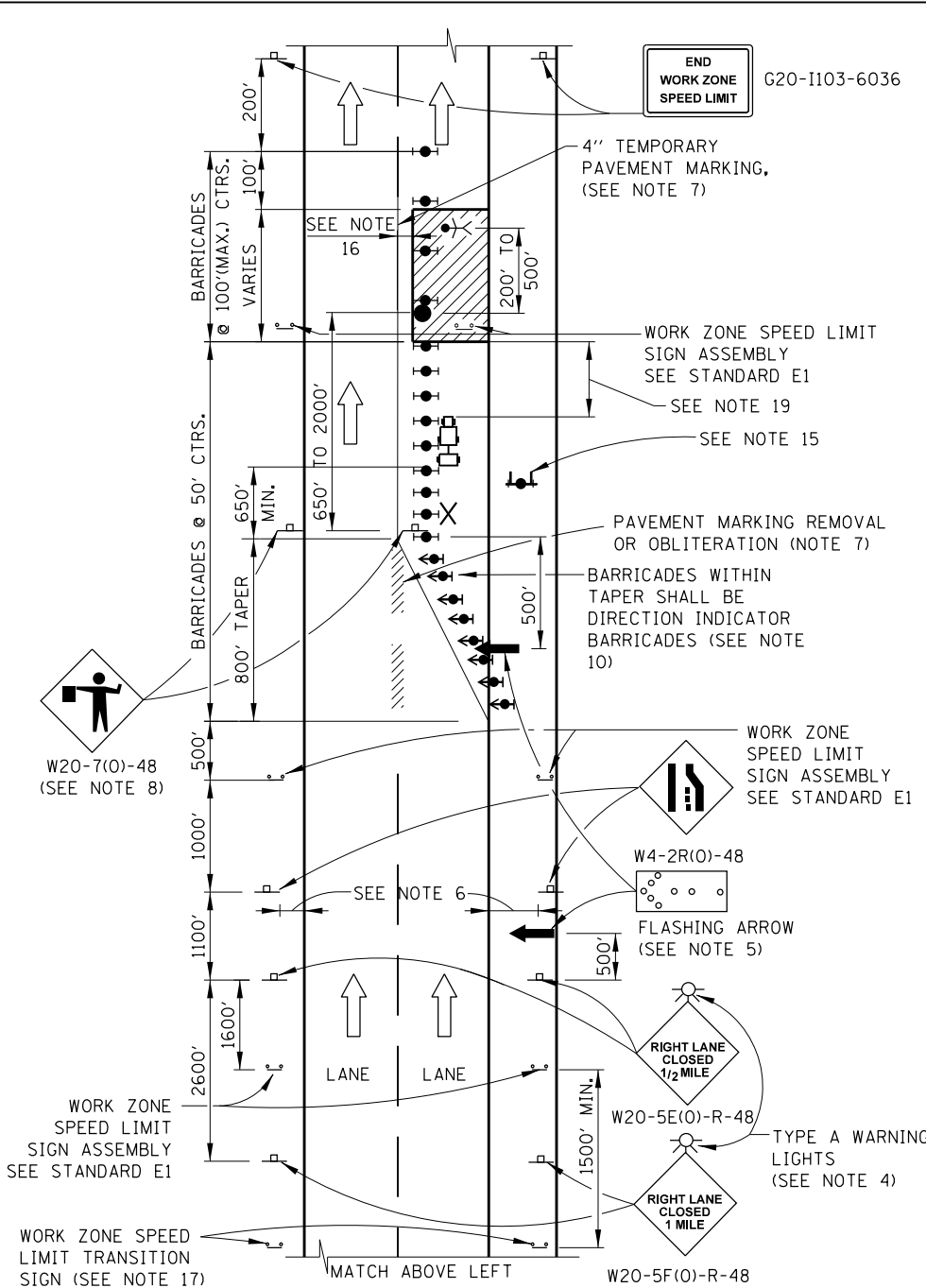

ONE - LANE CLOSURE WITH BARRICADE

TAPER RATES

WORK ZONE SPEED (mph)	SHY LINE (ft.)	BARRIER INSIDE SHY LINE	BARRIER AT OR BEYOND SHY LINE
65	8.5	28:1	19:1
60	8	26:1	18:1
55	7	24:1	16:1
50	6.5	21:1	14:1
45	6	18:1	12:1
40	5	16:1	10:1
35	4.5	15:1	9:1
30	4	13:1	8:1

LEGEND

- ARROW BOARD
- WORK AREA
- SIGN
- DIRECTION INDICATOR BARRICADE WITH SEQUENTIAL FLASHING WARNING LIGHT
- TYPE II BARRICADE, DRUM, OR VERTICAL BARRICADE WITH LIGHT IF REQUIRED. SEE ARTICLE 701.05(d)(5)
- FLAGGER WITH TRAFFIC CONTROL SIGN
- WORKER
- LANE CLOSED
- CHECK BARRICADE
- TRUCK MOUNTED ATTENUATOR

APPROVED: *Paul Kovacs* CHIEF ENGINEERING OFFICER DATE 5-1-2009

Illinois Tollway

LANE CLOSURE DETAILS

STANDARD E2-10

LEGEND

- ARROW BOARD
- WORK AREA
- SIGN
- DIRECTION INDICATOR BARRICADE WITH SEQUENTIAL FLASHING WARNING LIGHT
- TYPE II BARRICADE, DRUM, OR VERTICAL BARRICADE WITH LIGHT IF REQUIRED. SEE ARTICLE 701.05(a)(5)
- FLAGGER WITH TRAFFIC CONTROL SIGN
- WORKER
- LANE CLOSED
- CHECK BARRICADE
- TRUCK MOUNTED ATTENUATOR

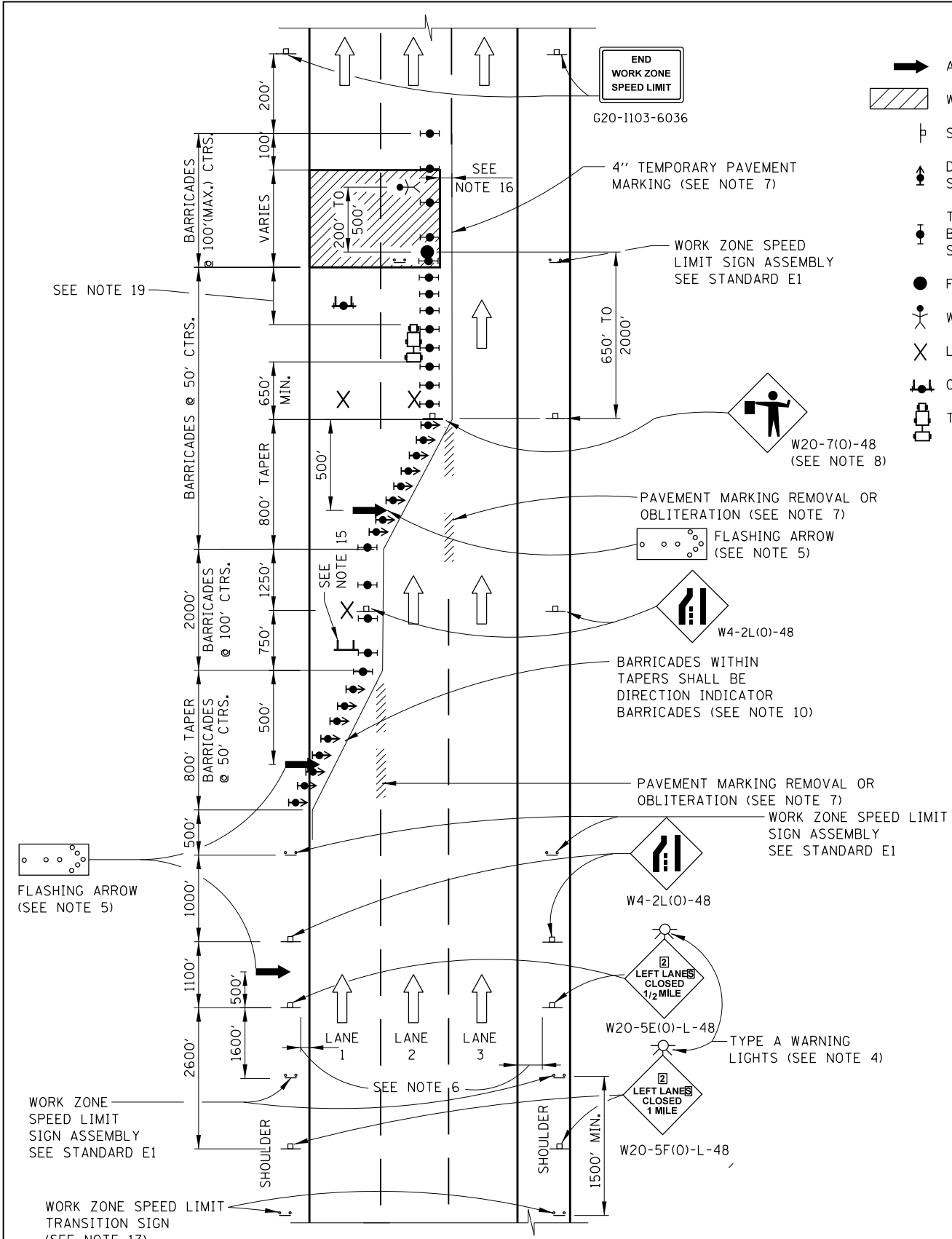

MATCH ADVANCED SIGNING ON SHEET 1
TWO - LANE CLOSURE WITH BARRICADE
 ACTUAL NUMBER OF LANES VARIES (TYP.)

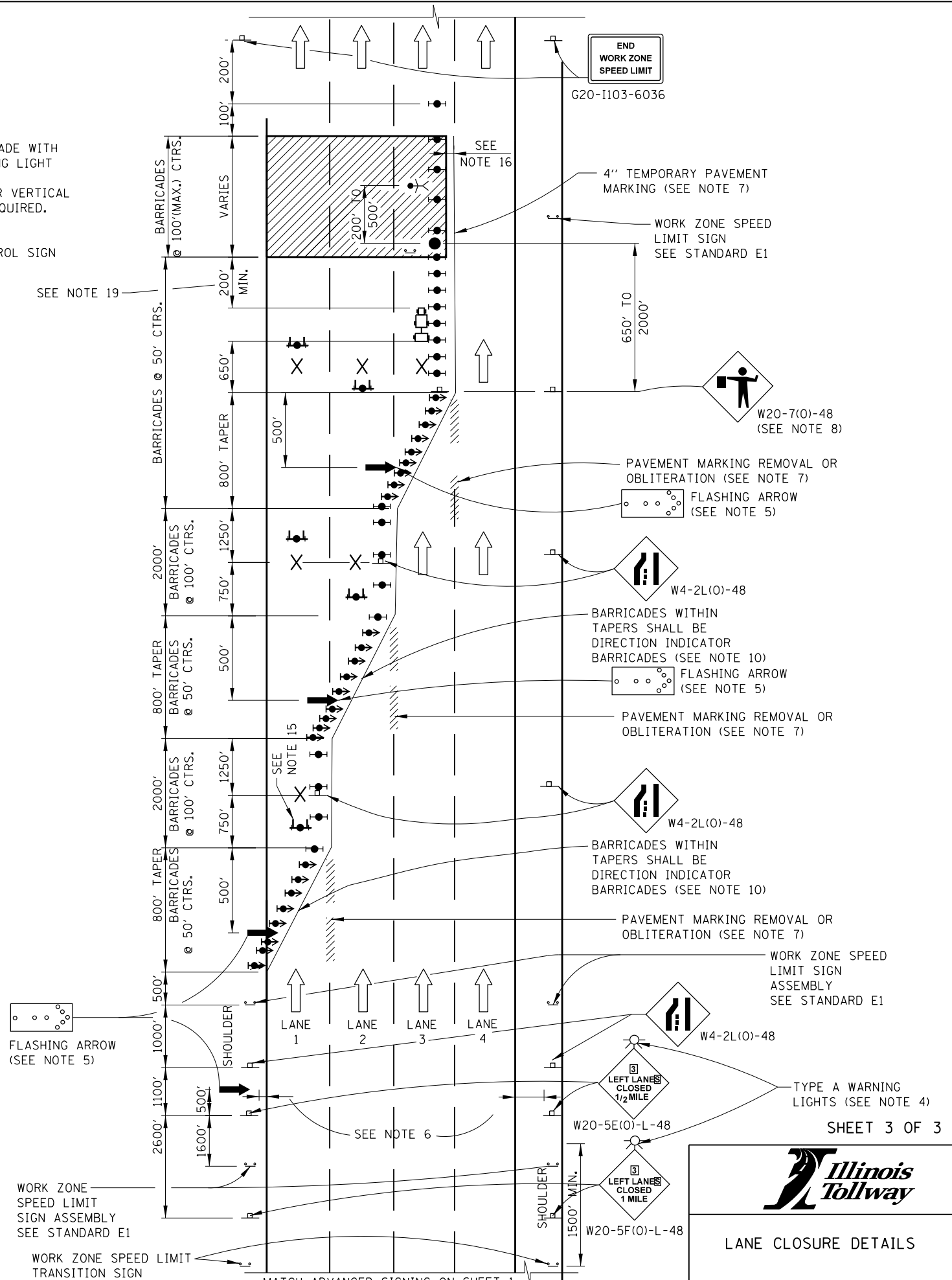

MATCH ADVANCED SIGNING ON SHEET 1
THREE - LANE CLOSURE WITH BARRICADE

Paul Kovacs
 APPROVED... DATE 5-1-2009...
 CHIEF ENGINEERING OFFICER

SEE SHEET 1 IN THIS SERIES FOR NOTES

SHEET 3 OF 3

LANE CLOSURE DETAILS

STANDARD E2-10

GENERAL NOTES:

1. THE SHOULDER SHALL BE CLOSED WHEN A WORK ACTIVITY REQUIRING 15 OR MORE MINUTES IS PERFORMED AT A DISTANCE WHICH IS LESS THAN 15 FEET BUT NO CLOSER THAN 2 FEET FROM THE EDGE OF PAVEMENT.
2. THE ADJACENT EXTERIOR LANE SHALL BE CLOSED WHEN WORK IS PERFORMED WITHIN 2 FEET FROM THE EDGE OF PAVEMENT.
3. THE CHANNELIZING DEVICES WHICH SEPARATE THE WORK SPACE FROM THE ADJACENT TRAVEL LANE SHALL BE SPACED AT 25' FOR (200 FEET) AND AT A MAXIMUM OF 50' FOR ALL ADDITIONAL DEVICES.
4. WHEN THE WORK SITE IS UNATTENDED, SUBSTITUTE - "SHOULDER WORK AHEAD" SIGN.
5. WORKER SIGNS OR SHOULDER WORK SIGNS AND CHANNELIZATION DEVICES ARE PLACED ONLY ON THE SIDE OF THE ROADWAY ON WHICH THE ACTIVITY IS PERFORMED.
6. FOR SHOULDER CLOSURE EXTENDING OVERNIGHT, BARRICADE TYPE II SHALL BE USED. SEE ARTICLE 701.05(d)(5) FOR BARRICADE LIGHT REQUIREMENTS
7. FOR SHORT TERM CLOSURE (SUNRISE TO ONE HOUR BEFORE SUNSET) NOT EXTENDING INTO DARKNESS, CONES MAY BE USED.
8. ONE WORK ZONE SPEED LIMIT SIGN ASSEMBLY SHALL BE PLACED AT A DISTANCE OF 500' TO 2,500' MAXIMUM IN ADVANCE OF WORKERS THROUGHOUT THE SHOULDER CLOSURE. MOVING OPERATIONS MAY REQUIRE CONTINUOUS ADJUSTMENT OF THE SIGN ASSEMBLY LOCATION TO MAINTAIN THE ABOVE INTERVAL.
9. AN ADDITIONAL SIGN ASSEMBLY SHALL BE PLACED 500' BEYOND THE LAST ENTRANCE RAMP FOR EACH INTERCHANGE THAT FALLS WITHIN THE 2,500'.
10. THE SIGN ASSEMBLY SHALL BE PLACED NO CLOSER THAN 500' TO ANY OTHER SIGN.
11. THE WORK ZONE SPEED LIMIT SIGNS AND SIGN ASSEMBLY SHALL BE PROMPTLY REMOVED OR COVERED WHEN SHOULDER CLOSURE IS REMOVED.
12. ALL CONFLICTING SPEED LIMIT SIGNS SHALL BE COVERED OR REMOVED.
13. "END WORK ZONE SPEED LIMIT" SIGNS SHALL BE IN PLACE ONLY WHEN THE EXISTING POSTED SPEED > 55MPH.
14. FOR SHOULDER REPAIRS OR REPLACEMENT THE CHANNELIZING DEVICES SHALL BE PLACED AT THE EDGE OF PAVEMENT WHENEVER THE WORK ACTIVITIES RESULT IN A DROP OFF AT THE EDGE OF PAVEMENT.
15. ANY UNATTENDED OBSTACLE OR EXCAVATION LEFT ON THE SHOULDER OVERNIGHT SHALL BE IN COMPLIANCE WITH THE ROADWAY TRAFFIC CONTROL AND COMMUNICATIONS MANUAL.
16. A 1'-0" MINIMUM/2'-0" DESIRABLE SHY DISTANCE SHALL BE PROVIDED, MEASURED BETWEEN EDGE OF PAVEMENT LANE MARKING TO THE EDGE OF THE TRAFFIC CONTROL DEVICE.
17. SEE STANDARD E1 FOR ADDITIONAL SIGNAGE REQUIRED WHEN WORK ZONE SPEED LIMIT IS REDUCED BY MORE THAN 10 MPH.
18. IN WORK ZONES WITH NO POSITIVE PROTECTION, A TRUCK MOUNTED ATTENUATOR SHALL BE PROVIDED WITH A BUFFER AREA BETWEEN THE FRONT OF THE TMA AND WORKERS OR EQUIPMENT. THE BUFFER AREA SHALL BE 200' UNLESS OTHERWISE DETERMINED. WHERE WORKERS OR EQUIPMENT ARE PRESENT BEYOND THE WORK AREA, AN ADDITIONAL TMA SHALL BE PROVIDED FOR EACH WORK AREA IS DEFINED AS STARTING AT THE END OF THE BUFFER AREA, EXTENDING 1000 FEET BEYOND THIS POINT.

TAPER RATES

WORK ZONE SPEED (mph)	SHY LINE (ft.)	BARRIER INSIDE SHY LINE	BARRIER AT OR BEYOND SHY LINE
65	8.5	28:1	19:1
60	8	26:1	18:1
55	7	24:1	16:1
50	6.5	21:1	14:1
45	6	18:1	12:1
40	5	16:1	10:1
35	4.5	15:1	9:1
30	4	13:1	8:1

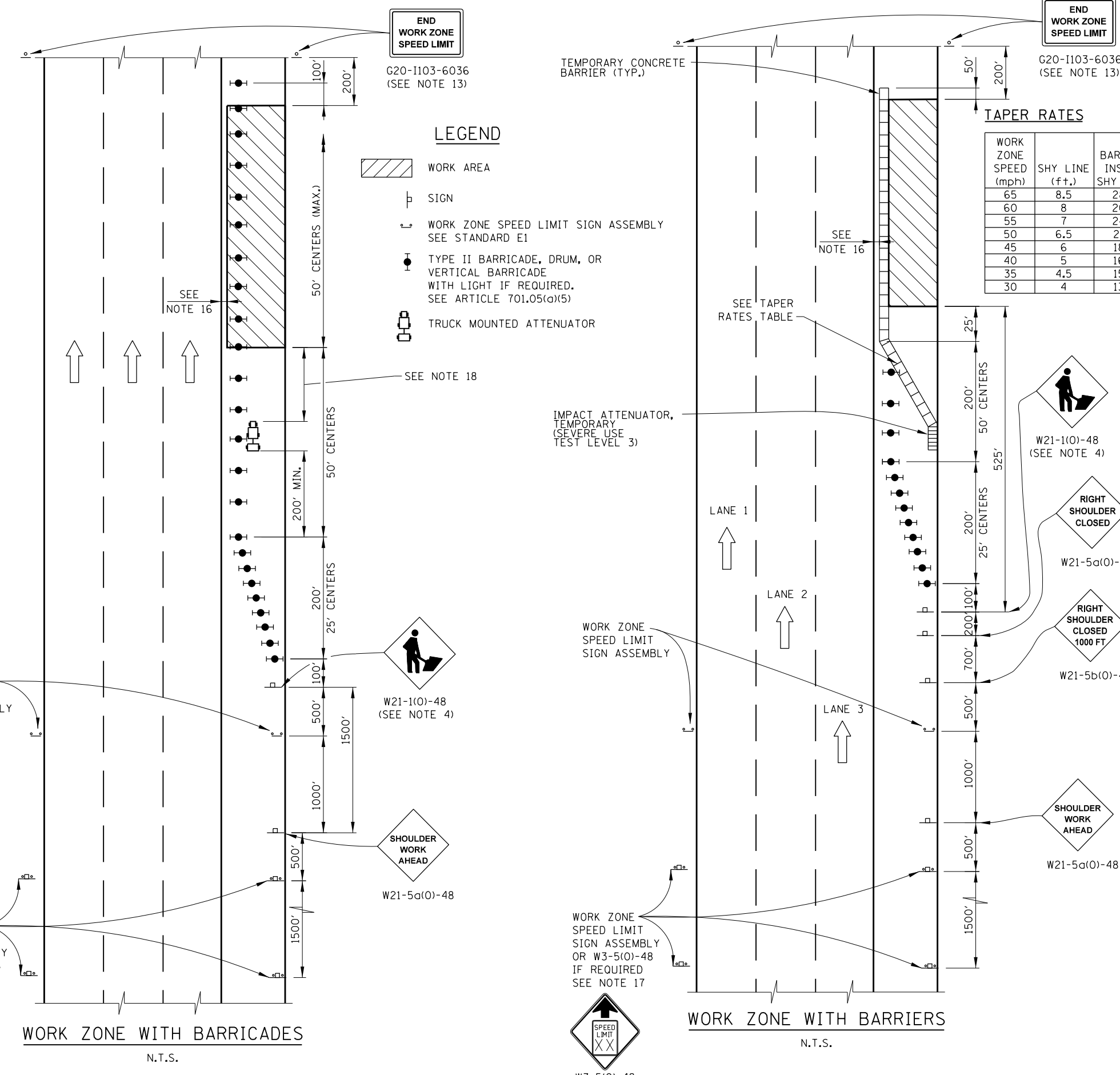

W3-5(0)-48

WORK ZONE WITH BARRICADES
N.T.S.

WORK ZONE WITH BARRIERS
N.T.S.

APPROVED: *Paul Kovacs* DATE 5-1-2009
CHIEF ENGINEERING OFFICER

DATE	REVISIONS
3-01-2021	DELETED WORK ZONE PUBLIC INFORMATION SIGN
3-01-2020	CLARIFIED TMA REQUIREMENTS & UPDATED BARRICADE LIGHT REQUIREMENTS
3-01-2019	DELETED W21-1a, ADJUSTED SIGN SPACING, ADDED TMA, REVISED NOTES
3-31-2017	ADDED TAPER RATE TABLE.
3-31-2016	ADD WORK ZONE WITH BARRIERS.
3-11-2015	REVISED NOTES
3-31-14	REVISED WORKER SIGN NUMBERS PER "MUTCD" AND REVISED NOTES.



SHOULDER CLOSURE DETAILS

STANDARD E3-09

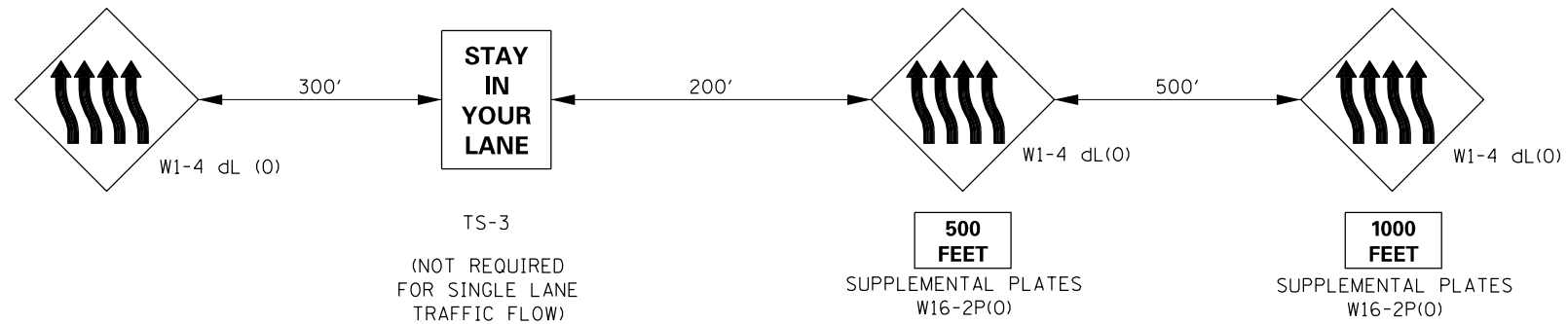

ADVANCE WARNING SEQUENCE

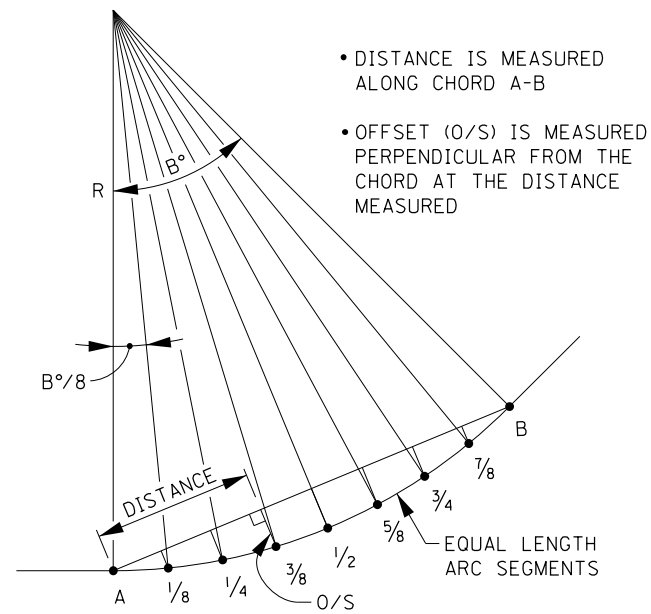
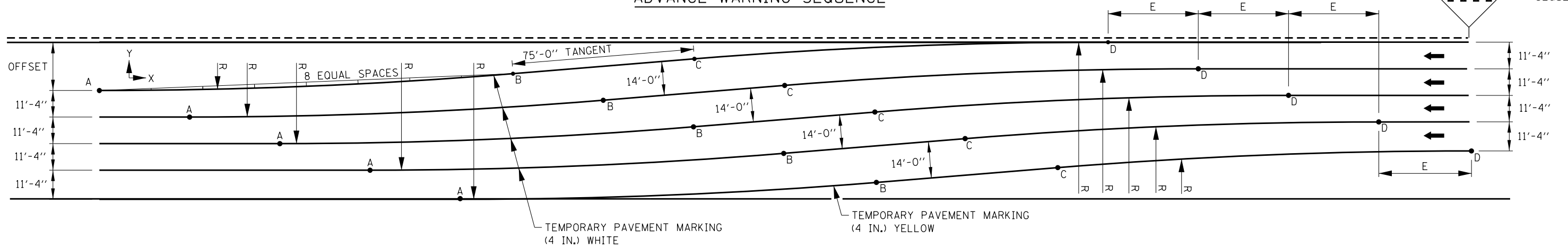

CHORD OFFSET SKETCH

- DISTANCE IS MEASURED ALONG CHORD A-B
- OFFSET (O/S) IS MEASURED PERPENDICULAR FROM THE CHORD AT THE DISTANCE MEASURED

GENERAL NOTES:

1. REVERSE CURVE INFORMATION CAN BE USED FOR SINGLE LANE OR MULTILANE TRAFFIC FLOWS, SHIFTING RIGHT TO LEFT (AS SHOWN) OR LEFT TO RIGHT BY CHANGING TO THE APPROPRIATE ADVANCE WARNING SEQUENCE.
2. THE REVERSE CURVE SHALL NOT BE USED OUTSIDE THE ACTIVITY AREA. LANE SHIFTS IN ADVANCE OF OR ON THE APPROACH TO THE ACTIVITY AREA SHALL BE IMPLEMENTED WITH A SHIFT RATE OF 65:1.
3. LANE SHIFTS FOR DEPARTURES OUT OF THE ACTIVITY AREA SHALL BE IMPLEMENTED WITH A SHIFT RATE OF 65:1.

DATE	REVISIONS
3-31-2017	REVISED TABLE DATA ON SHEET 2.
3-31-2016	REVISED TABLE DATA ON SHEET 2.
3-11-2015	REVISED NOTES AND ADDED RADIUS DIMENSIONS TO TABLES.
3-31-14	REVISED CURVE DATA PER MPH AND REVISED NOTES.
11-01-12	REVISED NOTES.
2-07-12	REVISED NOTES



APPROVED: *Paul Kovacs* CHIEF ENGINEER DATE 2-7-2012

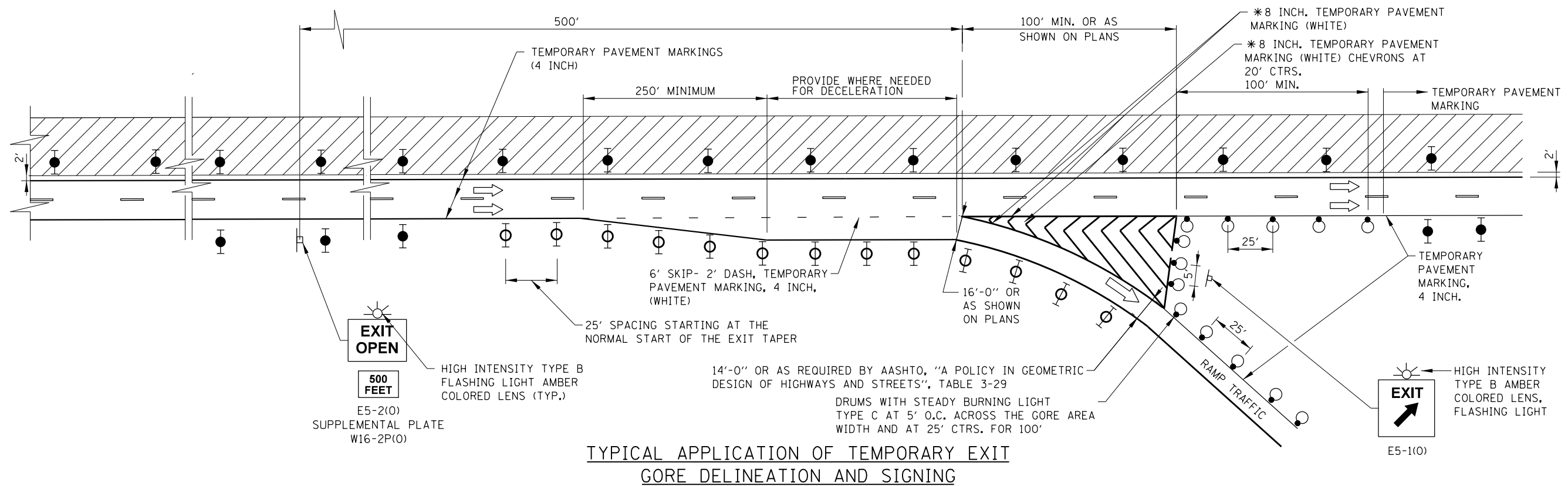

TYPICAL APPLICATION OF TEMPORARY EXIT GORE DELINEATION AND SIGNING

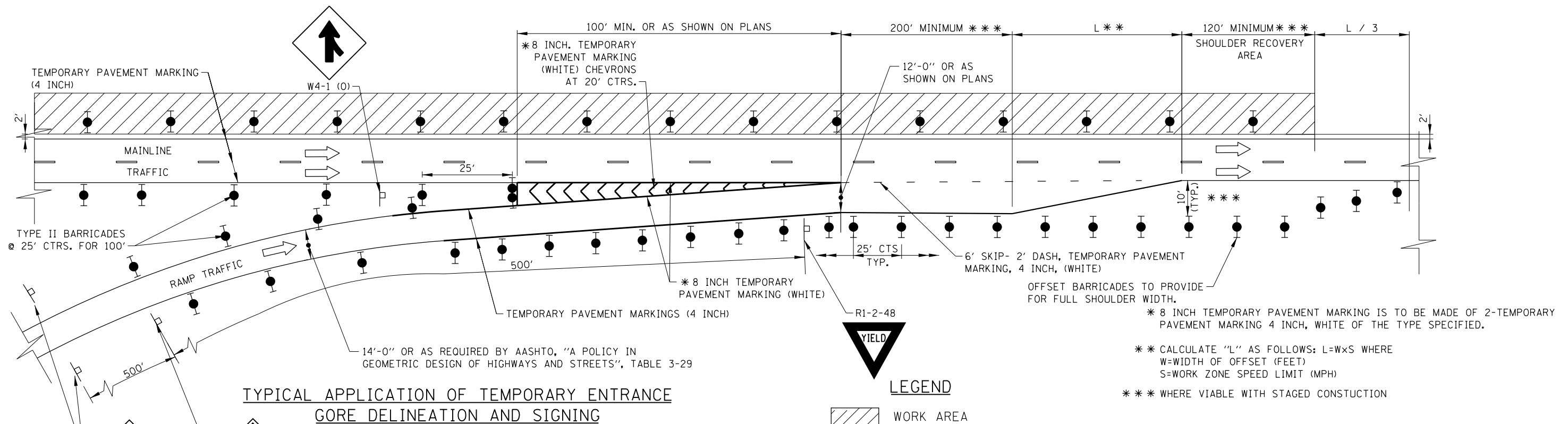

TYPICAL APPLICATION OF TEMPORARY ENTRANCE GORE DELINEATION AND SIGNING

LEGEND

- WORK AREA
- SIGN
- TYPE II BARRICADE, DRUM, OR VERTICAL BARRICADE WITH LIGHT IF REQUIRED. SEE ARTICLE 701.05(D)(5) BARRICADE TYPE USED ON MAINLINE SHALL BE DIFFERENT THAN BARRICADE TYPE USED ON TAPER.
- DRUM WITH LIGHT IF REQUIRED SEE ARTICLE 701.05(d)(5)
- TYPE III BARRICADE

*** WHERE VIABLE WITH STAGED CONSTRUCTION

** CALCULATE "L" AS FOLLOWS: $L = W \times S$ WHERE
 W=WIDTH OF OFFSET (FEET)
 S=WORK ZONE SPEED LIMIT (MPH)

* 8 INCH TEMPORARY PAVEMENT MARKING IS TO BE MADE OF 2-TEMPORARY PAVEMENT MARKING 4 INCH, WHITE OF THE TYPE SPECIFIED.

NOTES:

1. WHEN TEMPORARY PAVEMENT MARKING IS NOT REQUIRED, TEMPORARY GORES MAY BE DELINEATED BY DRUMS WITH STEADY BURN LIGHTS AT 25' C-C ACCORDING TO THE CONFIGURATIONS SHOWN.
2. THE TAPER LENGTHS ARE MINIMUMS. EXISTING ACCELERATION, DECELERATION, AND TAPER LENGTHS SHOULD BE PRESERVED TO THE EXTENT POSSIBLE.



TEMPORARY GORE DETAILS

STANDARD E5-09

DATE	REVISIONS
3-11-2015	REVISED EXIT/ENTRANCE DETAIL LAYOUTS REMOVED DETAILS NOT NEEDED.
3-31-2016	REVISED ENTRANCE GORE DETAIL.
3-31-2017	REVISED EXIT GORE DRUM LAYOUT
3-01-2018	REVISED DIMENSIONS FOR ENTRANCE TAPER.
3-01-2019	REVISED EXIT BARRICADES, ADDED EXIT OPEN 1000 FT SIGN
3-1-2020	PROVIDED DETAILS FOR INSIDE AND OUTSIDE WORK ZONES, PROVIDED ACCEL. & DECEL. DISTANCE WHERE VIABLE

APPROVED: *Paul Kovacs* DATE: 5-1-2009
 CHIEF ENGINEERING OFFICER

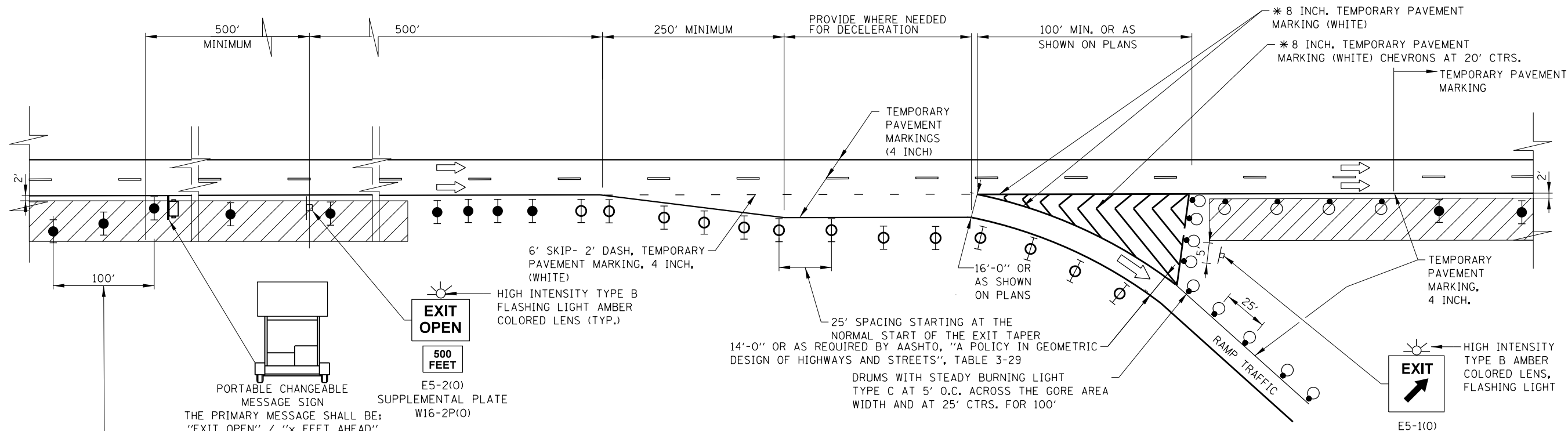

TYPICAL APPLICATION OF TEMPORARY EXIT GORE DELINEATION AND SIGNING

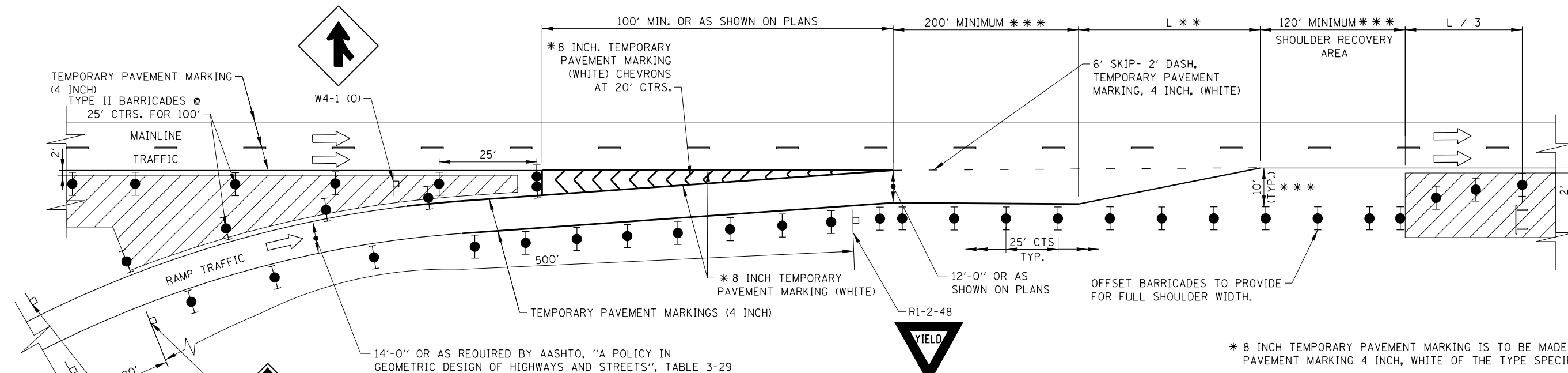

TYPICAL APPLICATION OF TEMPORARY ENTRANCE GORE DELINEATION AND SIGNING

LEGEND

- WORK AREA
- SIGN
- TYPE II BARRICADE, DRUM, OR VERTICAL BARRICADE WITH LIGHT IF REQUIRED. SEE ARTICLE 701.05(D)(5)
- BARRICADE TYPE USED ON MAINLINE SHALL BE DIFFERENT THAN BARRICADE TYPE USED ON TAPER.
- DRUM WITH LIGHT IF REQUIRED SEE ARTICLE 701.05(d)(5)
- TYPE III BARRICADE

* 8 INCH TEMPORARY PAVEMENT MARKING IS TO BE MADE OF 2-TEMPORARY PAVEMENT MARKING 4 INCH, WHITE OF THE TYPE SPECIFIED.
 ** CALCULATE "L" AS FOLLOWS: L=WxS WHERE W=WIDTH OF OFFSET (FEET) S=WORK ZONE SPEED LIMIT (MPH)
 *** WHERE VIABLE WITH STAGED CONSTRUCTION
 **** MINIMUM STOPPING DISTANCE

NOTES:

1. WHEN TEMPORARY PAVEMENT MARKING IS NOT REQUIRED, TEMPORARY GORES MAY BE DELINEATED BY DRUMS WITH STEADY BURN LIGHTS AT 25' C-C ACCORDING TO THE CONFIGURATIONS SHOWN.
2. THE TAPER LENGTHS ARE MINIMUMS. EXISTING ACCELERATION, DECELERATION, AND TAPER LENGTHS SHOULD BE PRESERVED TO THE EXTENT POSSIBLE.



TEMPORARY GORE DETAILS

STANDARD E5-09

APPROVED: *Paul Kovacs* CHIEF ENGINEERING OFFICER DATE: 5-1-2009

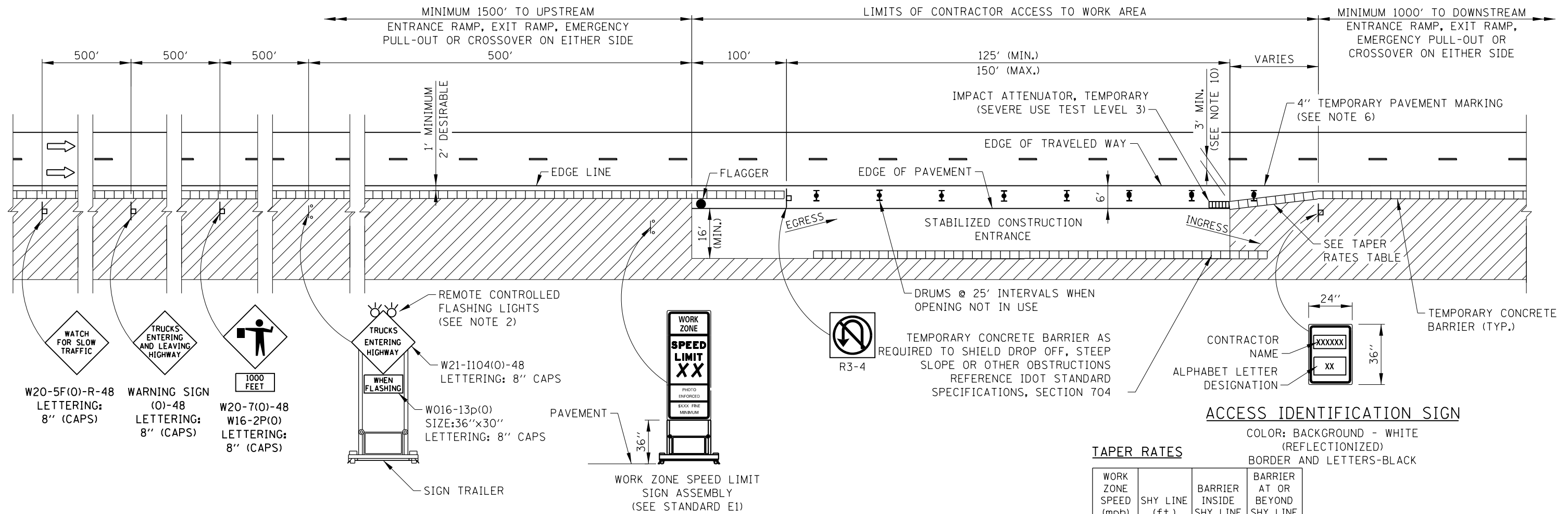

CONTRACTOR ACCESS TO WORK AREA WITH BARRIER WALL

NOTES:

- SIGNS DESIGNATED FOR THIS ACCESS TO WORK AREA SHALL BE COVERED OR TURNED AWAY FROM THE TRAFFIC WHEN THE FLAGGER IS NOT ON STATION AND THE ACCESS OPENINGS ARE NOT IN USE.
- THE FLASHING WARNING LIGHT SHALL MEET THE REQUIREMENTS OF ILLINOIS TOLLWAY SUPPLEMENTAL SPECIFICATIONS AND BE OPERATED BY THE FLAGGER REMOTELY. THE LIGHTS SHALL BE FLASHING ONLY WHEN A VEHICLE IS ENTERING THE ILLINOIS TOLLWAY.
- WHEN THREE LANES OR MORE ARE OPENED TO TRAFFIC, ADVANCE WARNING SIGNS AND ASSEMBLIES SHALL BE PROVIDED ON BOTH SIDES OF TRAVELED WAY.
- WHEN CONTRACTOR ACCESS TO WORK AREA IS ON OPPOSITE SIDE FROM SHOWN, ALL INSTALLATIONS ARE MIRROR IMAGE.
- FOR NIGHTTIME OPERATIONS, TEMPORARY LIGHTING OF CONSTRUCTION ACCESS TO WORK AREA SHALL BE PROVIDED.
- TEMPORARY PAVEMENT MARKINGS SHALL BE REPLACED AS OFTEN AS NECESSARY TO DELINEATE OPENINGS.
- IF POSSIBLE, LANE CLOSURES SHALL BE UTILIZED TO ELIMINATE THE MERGING OF CONSTRUCTION TRAFFIC INTO THROUGH TRAFFIC LANES.
- A 1'-0" MINIMUM/2'-0" DESIRABLE SHY DISTANCE SHALL BE PROVIDED, MEASURED BETWEEN EDGE OF PAVEMENT LANE MARKING TO THE EDGE OF THE TRAFFIC CONTROL DEVICES.
- "TRUCKS ENTERING HIGHWAY" SIGN MAY BE SUPPORTED BY OPTIONAL POST OR STAND MOUNTED DEVICES WHEN POSITIONED BEHIND TEMPORARY CONCRETE BARRIER.
- A TEMPORARY EXCEPTION TO THE 3' MINIMUM CLEARANCE BETWEEN EDGE OF TRAVELED WAY AND EDGE OF ATTENUATOR MAY BE REQUESTED FOR PCC PAVING OPERATIONS WHEN THIS CONFIGURATION DOES NOT PROVIDE 4' OF CLEARANCE BETWEEN BACK OF ATTENUATOR AND THE PROPOSED EDGE OF THE LANE BEING CONSTRUCTED IN THE CURRENT STAGE. THE DURATION OF REDUCED CLEARANCE SHALL BE LIMITED TO 24 HOURS.
- CONTRACTOR ACCESS LOCATIONS SHALL BE SPACED NO CLOSER THAN 2,600 FEET BETWEEN AREAS, EXCEPT FOR BRIDGE WORK WHERE 1 ACCESS LOCATION MAY BE PROVIDED ON EACH SIDE OF THE STRUCTURE. AT THESE LOCATIONS, ONLY 1 ACCESS LOCATION AT A TIME WILL BE ALLOWED TO BE OPEN FOR USE.
- EXITING THE WORK ZONE AT ANY PLACE OTHER THAN AT WORK ZONE EXIT OPENING WILL BE PROHIBITED.
- ALL VEHICLES SHALL USE THEIR TURN SIGNALS TO WARN MOTORISTS WHEN ENTERING AND EXITING THE WORK ZONE OPENINGS.
- FLAGGERS SHALL NOT STOP TRAFFIC OR DIRECT TRAFFIC INTO AN ADJACENT LANE.
- IN WORK ZONES WITH NO POSITIVE PROTECTION, A TRUCK MOUNTED ATTENUATOR (TMA) SHALL BE PROVIDED WITH A BUFFER AREA BETWEEN THE FRONT OF THE TMA AND WORKERS OR EQUIPMENT. THE BUFFER AREA SHALL BE 200' UNLESS OTHERWISE DETERMINED. WHERE WORKERS OR EQUIPMENT ARE PRESENT BEYOND THE WORK AREA, AN ADDITIONAL TMA SHALL BE PROVIDED FOR EACH WORK AREA. A WORK AREA IS DEFINED AS STARTING AT THE END OF THE BUFFER AREA, EXTENDING 1000 FEET BEYOND THIS POINT.

ACCESS IDENTIFICATION SIGN

COLOR: BACKGROUND - WHITE (REFLECTIONIZED)
BORDER AND LETTERS-BLACK

TAPER RATES

WORK ZONE SPEED (mph)	SHY LINE (ft.)	BARRIER INSIDE SHY LINE	BARRIER AT OR BEYOND SHY LINE
65	8.5	28:1	19:1
60	8	26:1	18:1
55	7	24:1	16:1
50	6.5	21:1	14:1
45	6	18:1	12:1
40	5	16:1	10:1
35	4.5	15:1	9:1
30	4	13:1	8:1

LEGEND

- FLAGGER
- SPOTTER
- ▮ CONSTRUCTION SIGN ON SUPPORT PER ILLINOIS TOLLWAY STANDARD UNLESS NOTED
- ➡ DIRECTION OF TRAFFIC FLOW
- ▨ WORK AREA
- ⊥ DRUM WITH LIGHT IF REQUIRED. SEE ARTICLE 701.05(d)(5)
- 🚚 TRUCK MOUNTED ATTENUATOR (TMA) (ROLL WITH MOVING OPERATION)

Paul Kovacs
APPROVED... DATE 2-7-2012...
CHIEF ENGINEERING OFFICER

DATE	REVISIONS
3-01-2020	CLARIFIED TMA REQUIREMENTS & UPDATED BARRICADE LIGHT REQ.
3-01-2019	ADDED SHEET FOR DETAILS WITHOUT BARRIER WALL
3-01-2018	ADDED NOTES 10 & 11
3-31-2017	ADDED TAPER RATES TABLE
3-31-2014	REVISED NOTE FOR TEMPORARY CONCRETE BARRIER.
3-01-2013	REVISED NOTES.



CONTRACTOR ACCESS TO WORK AREA

STANDARD E6-06

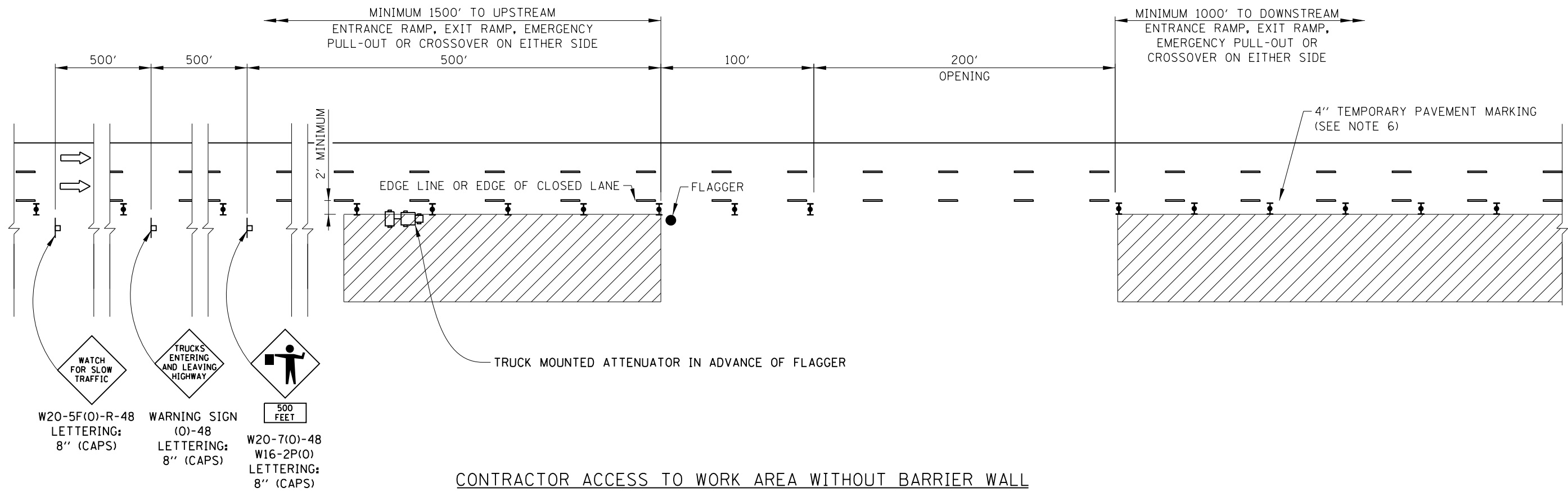

- LEGEND**
- FLAGGER
 - SPOTTER
 - CONSTRUCTION SIGN ON SUPPORT PER ILLINOIS TOLLWAY STANDARD UNLESS NOTED
 - ➔ DIRECTION OF TRAFFIC FLOW
 - ▨ WORK AREA
 - ⊞ DRUM WITH LIGHT IF REQUIRED. SEE ARTICLE 701.05(d)(5)
 - TRUCK MOUNTED ATTENUATOR (TMA) (ROLL WITH MOVING OPERATION)

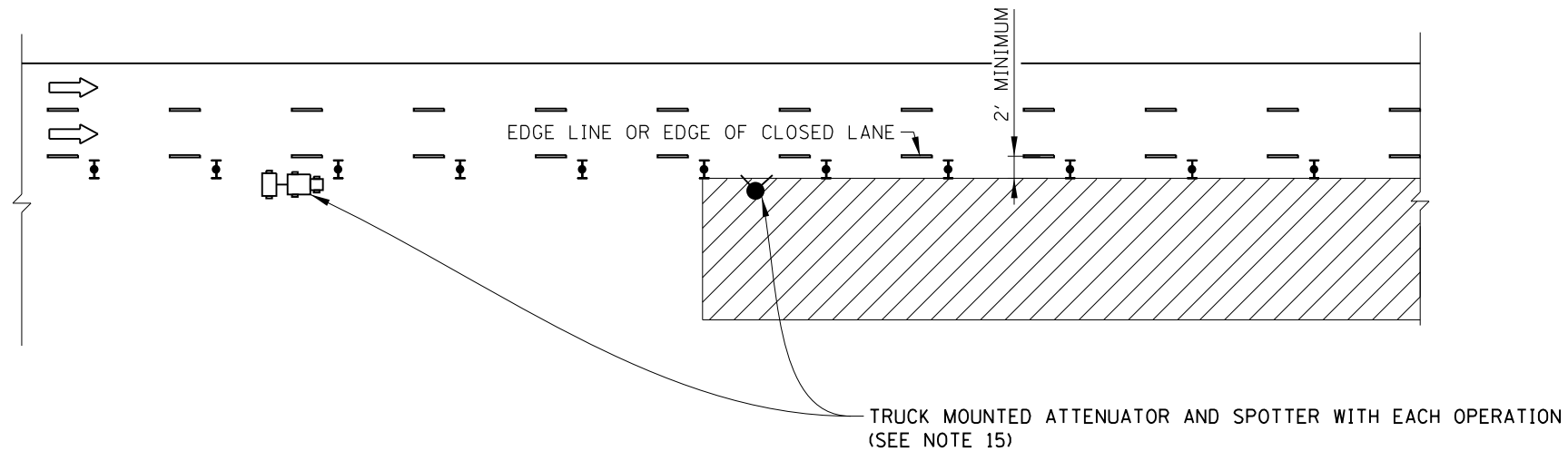

SPOTTER AND TMA AT WORK AREA



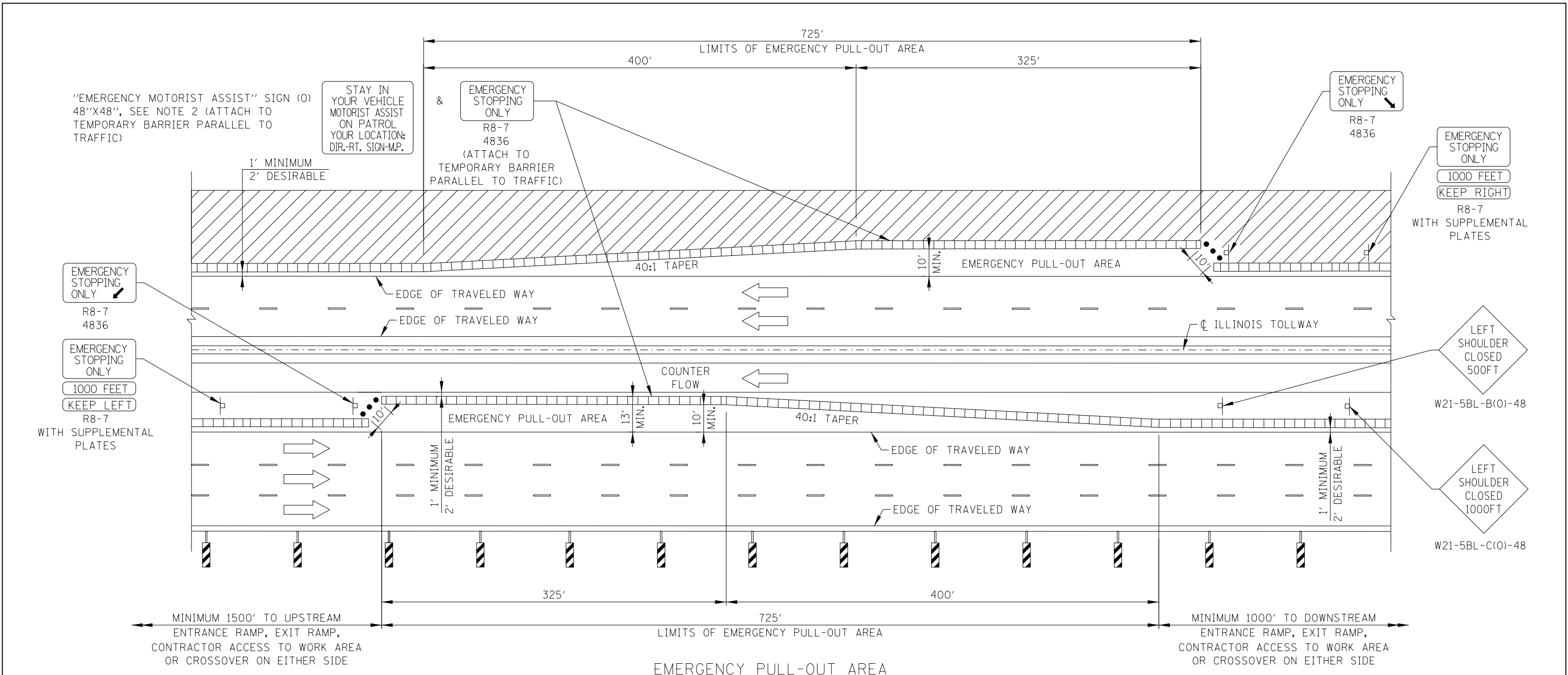

EMERGENCY PULL-OUT AREA

LEGEND

- TEMPORARY CONCRETE BARRIER WITH BARRIER DELINEATORS ON TRAFFIC SIDE
- VERTICAL PANELS @ 100 FT CENTERS ALONG ROADWAY (TANGENT) AND 50 FT CENTERS ALONG TAPERS.
- WORK AREA
- FLEXIBLE DELINEATOR POSTS
- DIRECTION OF TRAFFIC FLOW
- CONSTRUCTION SIGN ON SUPPORT PER ILLINOIS TOLLWAY STANDARD UNLESS NOTED.

NOTES:

1. PULL-OUT AREA SPACED PER CONTRACT DOCUMENTS.
2. ENGINEER TO DETERMINE EMERGENCY ASSIST SIGN'S INFORMATION FOR DIRECTION - ROUTE SIGN - MILEPOST ONCE THE LOCATION HAS BEEN ACCEPTED.
3. A 1'-0" MINIMUM/2'-0" DESIRABLE SHY DISTANCE SHALL BE PROVIDED, MEASURED BETWEEN EDGE OF PAVEMENT LANE MARKING TO THE EDGE OF THE TRAFFIC CONTROL DEVICE.
4. FLEXIBLE DELINEATORS TO BE 48" IN HEIGHT ABOVE BASE, TUBULAR POSTS (ORANGE) WITH 360 DEGREES FULL VIEW TWO-4" FLORESCENT ORANGE REFLECTORIZED TAPE BANDS. FLEXIBLE DELINEATORS SHALL BE CAPABLE OF BENDING UNDER REPEATED IMPACTS AND RETURN TO AN UPRIGHT POSITION WITHOUT DAMAGE TO THE IMPACTING VEHICLE OR THE DELINEATORS. THE DELINEATOR'S BASE SHALL BE SECURELY MOUNTED TO THE ROADWAY SURFACE. THE POSTS SHALL BE REMOVABLE FROM THE BASES TO PERMIT REPLACEMENT OF DAMAGED UNITS AS REQUIRED.

Paul Kovacs
 APPROVED..... CHIEF ENGINEER..... DATE 2-7-2012..

DATE	REVISIONS
03-01-20	REMOVED LIGHTS FROM VERTICAL PANELS
03-11-15	REVISED NOTES
03-31-14	ADDED ENFORCEMENT PULL-OUT AREA
03-01-13	REVISED "EMERGENCY MOTORIST ASSIST" SIGN NOTE.
11-01-12	REVISED LENGTH OF PULL-OUT AREA
	REVISED NOTES

SHEET 1 OF 2

PULL-OUT AREA

STANDARD E7-05

"EMERGENCY MOTORIST ASSIST" SIGN (O)
48"x48", SEE NOTE 2 (ATTACH TO
TEMPORARY BARRIER PARALLEL TO TRAFFIC)

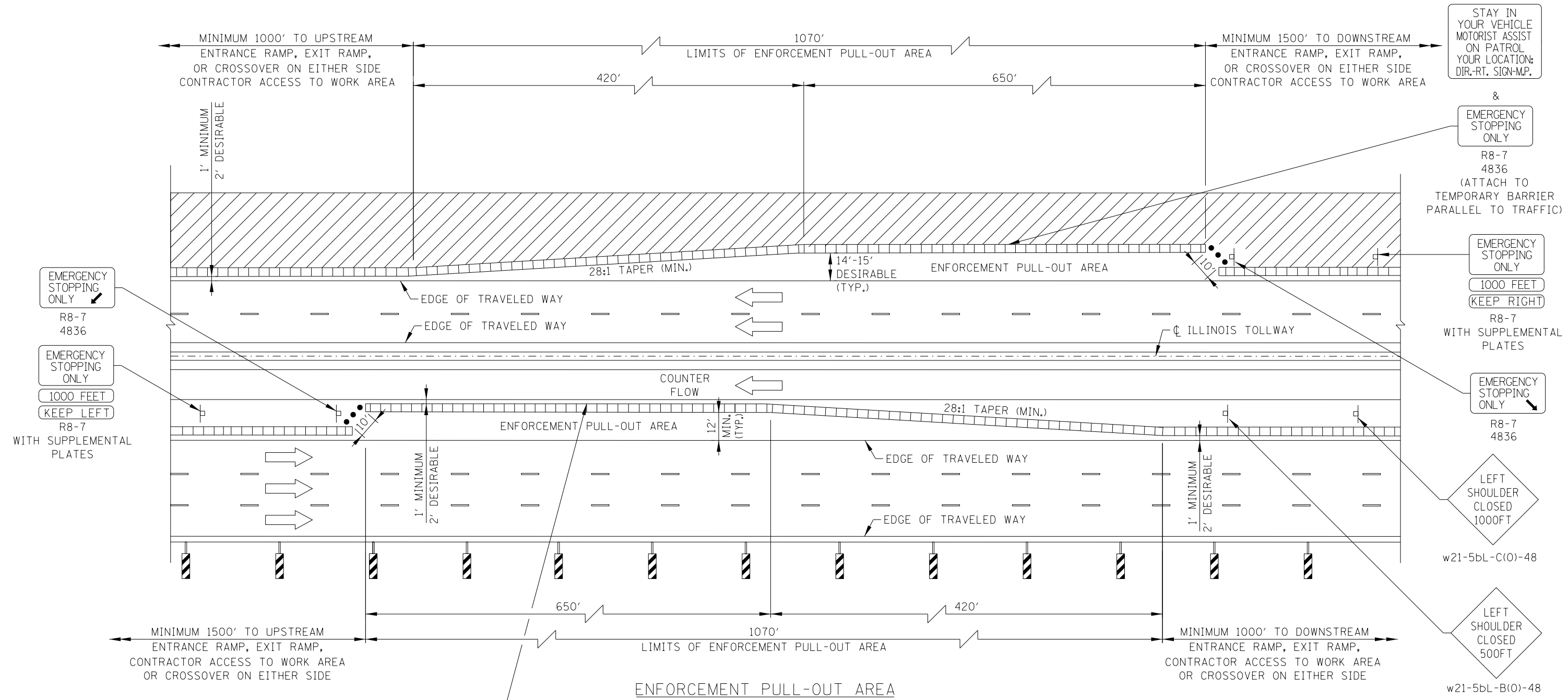

EMERGENCY STOPPING ONLY
R8-7
4836

EMERGENCY STOPPING ONLY
1000 FEET
KEEP LEFT
R8-7
WITH SUPPLEMENTAL PLATES

STAY IN YOUR VEHICLE
MOTORIST ASSIST
ON PATROL
YOUR LOCATION:
DIR.-RT. SIGN-M.P.

&
EMERGENCY STOPPING ONLY
R8-7
4836
(ATTACH TO
TEMPORARY BARRIER
PARALLEL TO TRAFFIC)

EMERGENCY STOPPING ONLY
1000 FEET
KEEP RIGHT
R8-7
WITH SUPPLEMENTAL PLATES

EMERGENCY STOPPING ONLY
R8-7
4836

LEFT SHOULDER
CLOSED
1000FT
w21-5bL-C(0)-48

LEFT SHOULDER
CLOSED
500FT
w21-5bL-B(0)-48

"EMERGENCY MOTORIST ASSIST" SIGN (O)
48"x48", SEE NOTE 2 (ATTACH TO
TEMPORARY BARRIER PARALLEL TO TRAFFIC)

STAY IN YOUR VEHICLE
MOTORIST ASSIST
ON PATROL
YOUR LOCATION:
DIR.-RT. SIGN-M.P.

&
EMERGENCY STOPPING ONLY
R8-7
4836
(ATTACH TO
TEMPORARY BARRIER
PARALLEL TO TRAFFIC)

- LEGEND**
- TEMPORARY CONCRETE BARRIER WITH BARRIER DELINEATORS ON TRAFFIC SIDE
 - VERTICAL PANELS @ 100 FT CENTERS ALONG ROADWAY (TANGENT) AND 50 FT CENTERS ALONG TAPERS.
 - WORK AREA
 - FLEXIBLE DELINEATOR POSTS
 - DIRECTION OF TRAFFIC FLOW
 - CONSTRUCTION SIGN ON SUPPORT PER ILLINOIS TOLLWAY STANDARD UNLESS NOTED.

SEE SHEET 1 IN THIS SERIES FOR NOTES.

Illinois Tollway

PULL-OUT AREA

STANDARD E7-05

Paul Kovacs
APPROVED... CHIEF ENGINEER... DATE 2-7-2012...